

DATA SHEET

THICK FILM CHIP RESISTORS

Precision grade

RE series

0.1%, 0.5%, 1%, TC 50

sizes 0201/0402/0603/0805/1206

RoHS compliant & Halogen Free

www.tocos.com



SCOPE

This specification describes RE0201 to RE1206 ultra precision chip resistors with lead-free terminations made by thick film process.

APPLICATIONS

- Converters
- Printer equipment
- Server board
- Telecom
- Consumer

FEATURES

- Halogen Free Epoxy
- RoHS compliant
- Reducing environmentally hazardous wastes
- High component and equipment reliability
- Non-forbidden material used in products/production
- Moisture sensitivity level: MSL 1

ORDERING INFORMATION - GLOBAL PART NUMBER & I2NC

Both part numbers are identified by the series, size, tolerance, packing type, temperature coefficient, taping reel and resistance value.

YAGEO BRAND ordering code

GLOBAL PART NUMBER (PREFERRED)

RE XXXX X X X XX XXXX L
 (1) (2) (3) (4) (5) (6) (7)

(1) SIZE

0201 / 0402 / 0603 / 0805 / 1206

(2) TOLERANCE

B = ±0.1%
 D = ±0.5%
 F = ±1%

(3) PACKAGING TYPE

R = Paper/PE taping reel

(4) TEMPERATURE COEFFICIENT OF RESISTANCE

E = ±50 ppm/°C

(5) TAPING REEL

07 = 7 inch dia. Reel
 13 = 13 inch dia. Reel

(6) RESISTANCE VALUE

There are 2~4 digits indicated the resistor value. Letter R/K/M is decimal point, no need to mention the last zero after R/K/M, e.g. 1K2, not 1K20.
 Detailed resistance rules show in table of "Resistance rule of global part number".

(7) DEFAULT CODE

Letter L is system default code for order only ^(Note)

Resistance code rule	Example
XXRX (10 to 97.6 Ω)	10R = 10 Ω 97R6 = 97.6 Ω
XXXR (100 to 976 Ω)	100R = 100 Ω
XKXX (1 to 9.76 KΩ)	1K = 1,000 Ω 9K76 = 9760 Ω
XMXX (1 MΩ)	1M = 1,000,000 Ω

ORDERING EXAMPLE

The ordering code of a RE0603 chip resistor, TC 50 value 56Ω with ±0.5% tolerance, supplied in 7-inch tape reel is: RE0603DRE0756RL.

NOTE

1. All our R-Chip products meet RoHS compliant and Halogen Free. "LFP" of the internal 2D reel label mentions "Lead Free Process"
2. On customized label, "LFP" or specific symbol can be printed

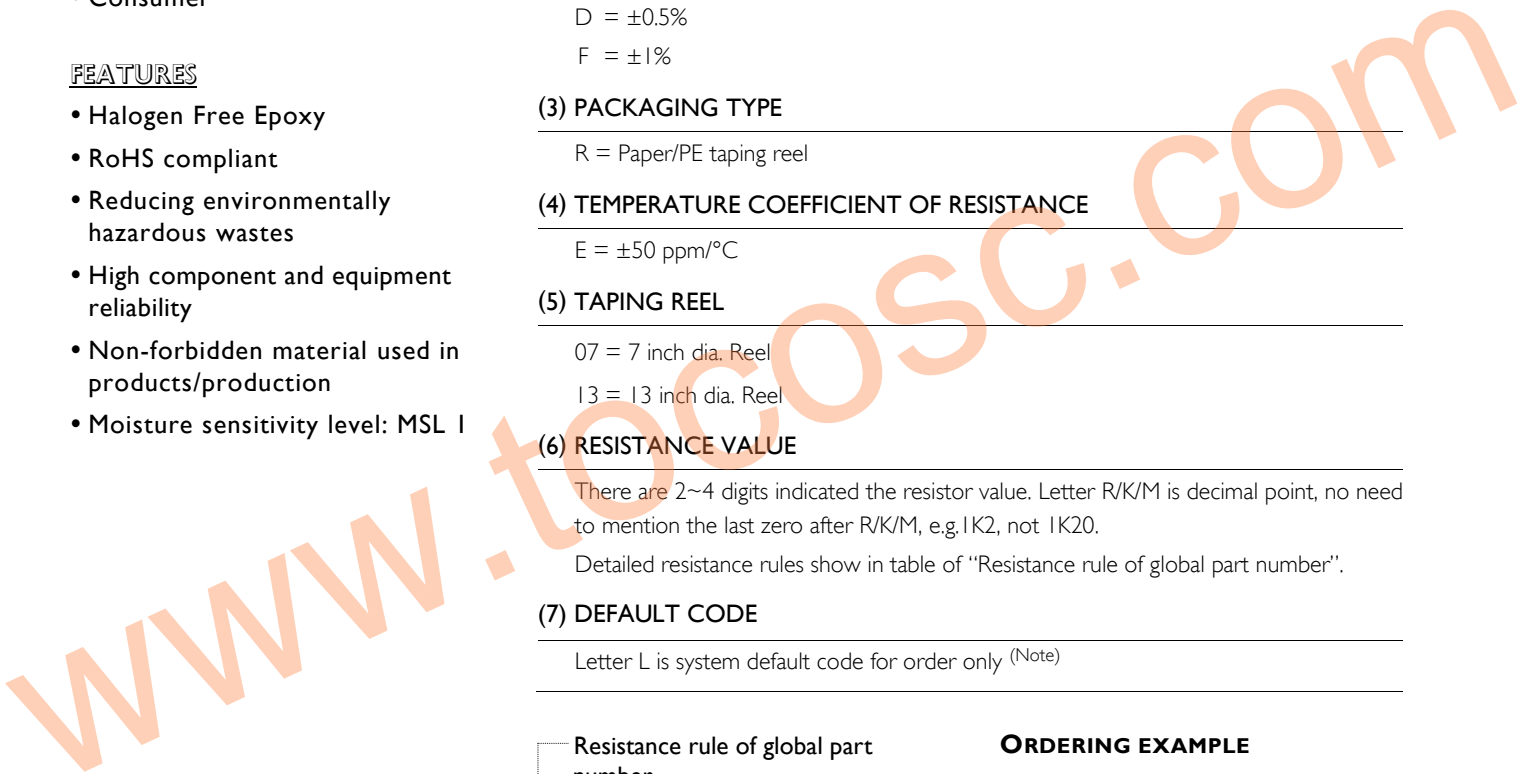

MARKING

RE0805 / RE1206

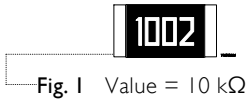

Either resistance in E-24 or E-96: 4 digits
First three digits for significant figure and 4th digit for number of zeros

RE0603

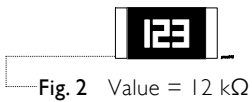

E-24 series: 3 digits
First two digits for significant figure and 3rd digit for number of zeros

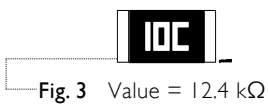

E-96 series: 3 digits for 0603±1% EIA-96 marking method

RE0201/0402

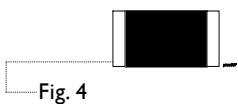

No marking

For further marking information, please see special data sheet "Chip resistors marking".

CONSTRUCTION

The resistors are constructed out of a high-grade ceramic body. Internal metal electrodes are added at each end and connected by a resistive layer. The resistive layer is adjusted to give the approximate required resistance and laser cutting of this resistive layer that achieves tolerance trims the value. The resistive layer is covered with a protective coat and printed with the resistance value. Finally, the two external terminations (matte tin) are added. See fig. 5.

OUTLINES

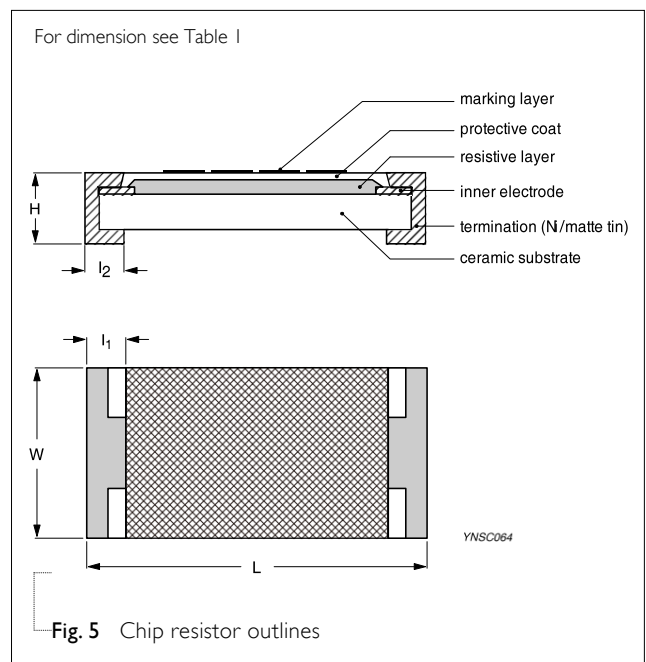

DIMENSION

Table I For outlines see fig. 5

TYPE	L (mm)	W (mm)	H (mm)	l ₁ (mm)	l ₂ (mm)
RE0201	0.60 ±0.03	0.30 ±0.03	0.23 ±0.03	0.10 ±0.05	0.15 ±0.05
RE0402	1.00 ±0.05	0.50 ±0.05	0.32 ±0.05	0.20 ±0.10	0.25 ±0.10
RE0603	1.60 ±0.10	0.80 ±0.10	0.45 ±0.10	0.25 ±0.15	0.25 ±0.15
RE0805	2.00 ±0.10	1.25 ±0.10	0.50 ±0.10	0.35 ±0.20	0.35 ±0.20
RE1206	3.10 ±0.10	1.60 ±0.10	0.55 ±0.10	0.45 ±0.20	0.40 ±0.20

ELECTRICAL CHARACTERISTICS

Table 2

TYPE	RESISTANCE RANGE (E24/E96)	OPERATING TEMPERATURE RANGE	POWER RATING	MAXIMUM WORKING VOLTAGE	DIELECTRIC WITHSTAND VOLTAGE	MAXIMUM OVERLOAD VOLTAGE	TEMPERATURE COEFFICIENT OF RESISTANCE
RE0201	100 Ω to 1 MΩ	-55 °C to +155 °C	1/20W	25 V	50 V	50 V	±50 ppm/°C
RE0402	10 Ω to 1 MΩ	-55 °C to +155 °C	1/16 W	50 V	100 V	100 V	±50 ppm/°C
RE0603	10 Ω to 1 MΩ	-55 °C to +155 °C	1/10 W	75 V	150 V	150 V	±50 ppm/°C
RE0805	10 Ω to 1 MΩ	-55 °C to +155 °C	1/8 W	150 V	300 V	300 V	±50 ppm/°C
RE1206	10 Ω to 1 MΩ	-55 °C to +155 °C	1/4 W	200 V	500 V	400 V	±50 ppm/°C

NOTE

The maximum working voltage that may be continuously applied to the resistor element, see “IEC publication 60115-8”

FOOTPRINT AND SOLDERING PROFILES

For recommended footprint and soldering profiles, please see the special data sheet “Chip resistors mounting”.

PACKING STYLE AND PACKAGING QUANTITY

Table 3 Packing style and packaging quantity

PACKING STYLE	REEL DIMENSION	RE0201	RE0402	RE0603	RE0805	RE1206
Paper/PE taping reel (R)	7" (178 mm)	10,000	10,000	5,000	5,000	5,000
	13" (330 mm)	50,000	50,000	20,000	20,000	20,000

NOTE

1. For Paper/PE tape and reel specification/dimensions, please see the special data sheet “Chip resistors packing”

FUNCTIONAL DESCRIPTION

POWER RATING

Each type rated power at 70°C:
 RE0201=1/20W, RE0402=1/16W, RE0603=1/10W,
 RE0805=1/8 W, RE1206=1/4W

RATED VOLTAGE

The DC or AC (rms) continuous working voltage corresponding to the rated power is determined by the following formula:

$V = \sqrt{P \times R}$
 or max. working voltage whichever is less

Where

V=Continuous rated DC or AC (rms) working voltage (V)

P=Rated power (W)

R=Resistance value (Ω)

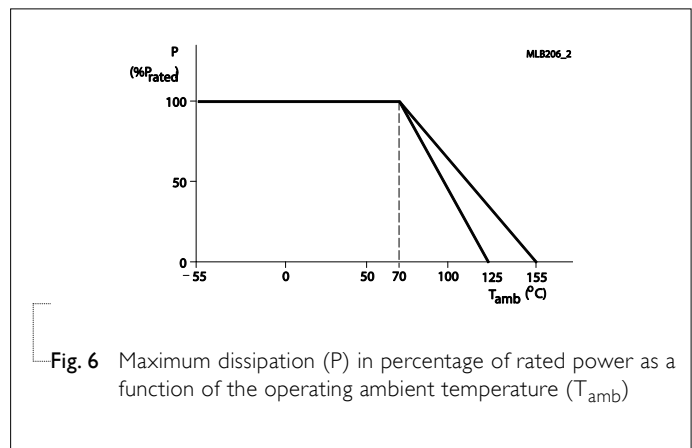

Fig. 6 Maximum dissipation (P) in percentage of rated power as a function of the operating ambient temperature (T_{amb})

TESTS AND REQUIREMENTS
Table 4 Test condition, procedure and requirements

TEST	TEST METHOD	PROCEDURE	REQUIREMENTS
Life/Endurance	IEC 60115-1 4.25.1 MIL-STD-202 Method 108A	At 70±2 °C for 1,000 hours, RCWV applied for 1.5 hours on, 0.5 hour off, still air required	±(3%+0.05 Ω)
High Temperature Exposure	IEC 60068-2-2 MIL-STD-202 Method 108A	1,000 hours at 155±5 °C, unpowered	±(3%+0.05 Ω)
Moisture Resistance	MIL-STD-202 Method 106G	Each temperature / humidity cycle is defined at 8 hours, 3 cycles / 24 hours for 10d. with 25 °C / 65 °C 95% R.H, without steps 7a & 7b, unpowered Parts mounted on test-boards, without condensation on parts Measurement at 24±2 hours after test conclusion	±(3%+0.05 Ω)
Thermal Shock	MIL-STD-202 Method 107G	-55/+125 °C Number of cycles required is 300. Devices mounted Maximum transfer time is 20 seconds. Dwell time is 15 minutes. Air – Air	±(1%+0.05 Ω)
Short Time Overload	IEC60115-1 4.13	2.5 times of rated voltage or maximum overload voltage whichever is less for 5 sec at room temperature	±(1%+0.05 Ω) No visible damage
Board Flex/Bending	IEC 60115-1 4.33	Chips mounted on a 90mm glass epoxy resin PCB (FR4) Bending: see table 5 for each size Bending time: 60±5 seconds	±(1%+0.05 Ω) No visible damage

TEST	TEST METHOD	PROCEDURE	REQUIREMENTS
Humidity	IEC 60115-1 4.24.2	Steady state for 1000 hours at 40 °C / 95% R.H. RCWV applied for 1.5 hours on and 0.5 hour off	$\pm(3\%+0.05 \Omega)$
Solderability - Wetting	J-STD-002 test B	Electrical Test not required Magnification 50X SMD conditions: 1 st step: method B, aging 4 hours at 155°C dry heat 2 nd step: leadfree solder bath at 245±3°C Dipping time: 3±0.5 seconds	Well tinned (≥95% covered) No visible damage
- Leaching	J-STD-002 test D	Leadfree solder, 260 °C, 30 seconds immersion time	No visible damage
- Resistance to Soldering Heat	IEC 60115-1 4.18	Condition B, no pre-heat of samples. Leadfree solder, 260 °C, 10 seconds immersion time Procedure 2 for SMD: devices fluxed and cleaned with isopropanol	$\pm(1\%+0.05 \Omega)$ No visible damage

Table 5 Bending for sizes 0201 to 1206

TYPE	RE0201	RE0402	RE0603	RE0805	RE1206
Specification (mm)	5	5	3	3	2

REVISION HISTORY

REVISION	DATE	CHANGE NOTIFICATION	DESCRIPTION
Version 4	May 03, 2016		-Update 0201 resistor value
Version 3	Jan. 26, 2015	-	- Update Working Voltage
Version 2	May 11, 2015	-	- Update test and requirements
Version 1	Jan 23, 2014	-	- Add RE0201 - Add 0.1% - Update TEST AND REQUIREMENTS, add Humidity test
Version 0	Dec 10, 2010	-	- New datasheet for thick film ultra precision chip resistors sizes of 0402/0603/0805/1206, 0.5%, 1%, TC50 with lead-free terminations

www.tocosc.com

“ Yageo reserves all the rights for revising the content of this datasheet without further notification, as long as the products itself are unchanged. Any product change will be announced by PCN.”