

片状独石陶瓷电容器

Chip Monolithic Ceramic Capacitors

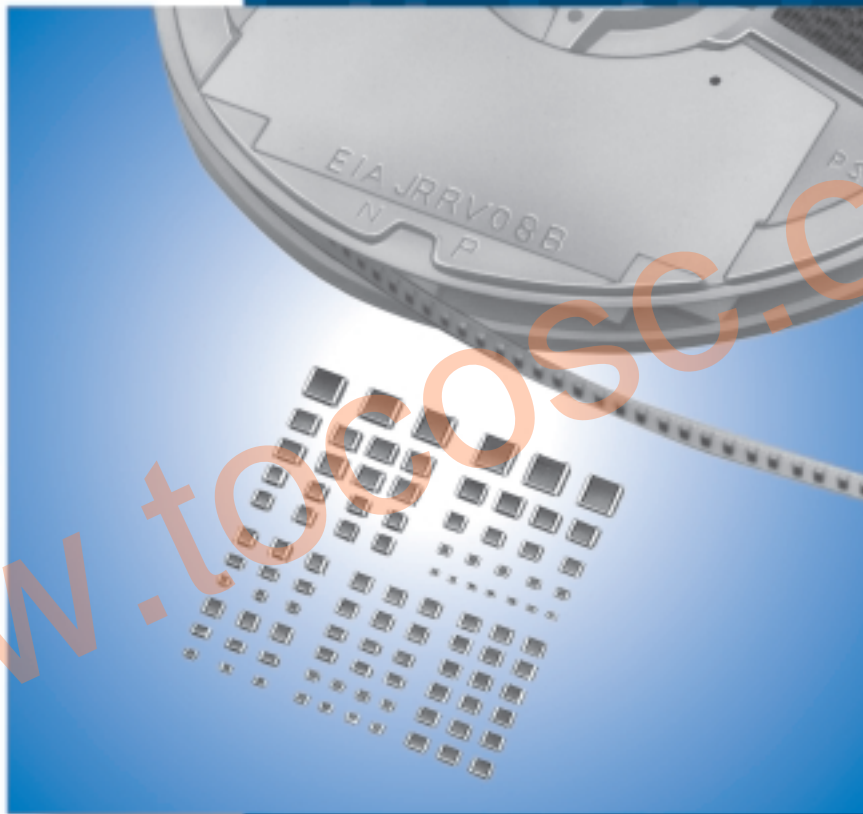

Innovator in Electronics

muRata

村田制作所

目录

品名表示法	_____	2
选择指南	_____	7
1 一般用GRM系列	_____	8
1 规格和测试方法	_____	51
●GRM系列数据	_____	60
2 排容 GNM系列	_____	63
2 规格和测试方法	_____	68
3 低ESL型 LLL/LLA/LLM系列	_____	73
3 规格和测试方法	_____	80
4 高Q值型 GJM系列	_____	84
4 规格和测试方法	_____	94
5 高频型 GQM系列	_____	97
5 规格和测试方法	_____	104
●GQM系列数据	_____	106
6 高频型 ERB系列	_____	107
6 规格和测试方法	_____	114
●ERB系列数据	_____	116
7 多层微片型GMA系列	_____	118
7 规格和测试方法	_____	120
8 结合 (Bonding) 用GMD系列	_____	124
8 规格和测试方法	_____	129
包装	_____	133
△警告	_____	137
注意事项	_____	149
参考资料	_____	156
9 中高压低失真型	_____	163
10 中高压大容量一般用	_____	168
11 LCD背光灯反相电路专用	_____	172
12 通信/信息设备专用	_____	175

13	照相机闪光电路专用	178
14	AC250V (r.m.s.) 型 (日本电器安全法基准品)	181
15	安全规格认证品 GC型 (UL , IEC60384-14 X1/Y2级)	185
16	安全规格认证品 GD型 (IEC60384-14 Y3级)	186
17	安全规格认证品 GF型 (IEC60384-14 Y2、 X1/Y2级)	187
18	安全规格认证品 GB型 (IEC60384-14 X2级)	189
	GA3系列规格和测试方法	190
	GRM/GR4/GR7/GA2/GA3系列数据 (典例)	193
	包装	196
	警告	199
	注意事项	207
	ISO 9001认证	210

● 请参阅第 9 - 14 章各章结尾处的“规格和测试方法”。

关于欧盟RoHS指令

- 本产品目录中的所有产品都符合欧盟RoHS指令。
- 欧盟RoHS指令是指欧盟的“关于在电子电气设备中限制使用某些有害物质指令 2002/95/EC”。
- 详情请参见本公司网站“Murata's Approach for EU RoHS” (<http://www.murata.com/info/rohs.html>)。

一旦您不能在目录上找到品名，请参见村田主页 (<http://www.murata.com/index.html>)。

● 品名表示法

片状独石陶瓷电容器

(品名)

GR	M	18	8	B1	1H	102	K	A01	D
①	②	③	④	⑤	⑥	⑦	⑧	⑨	⑩

① 型号

② 系列

型号	代号	系列
GR	M	镀锡电极品
	4	通讯/信息机器专用品
	7	照相机闪光电路专用
ER	B	高频型
GQ	M	高频型波峰/回流焊接用
GM	A	片状独石超小型
	D	结合用
GN	M	排容型
LL	L	低ESL宽幅型
	A	8终端低ESL型
	M	10终端低ESL型
GJ	M	高频低损失型
GA	2	AC250V (r.m.s) 用
	3	安全规格认证品

③ 尺寸 (长x宽)

代号	尺寸 (长x宽)	EIA
02	0.4×0.2mm	01005
03	0.6×0.3mm	0201
05	0.5×0.5mm	0202
08	0.8×0.8mm	0303
0D	0.38×0.38mm	015015
0M	0.9×0.6mm	0302
11	1.25×1.0mm	0504
15	1.0×0.5mm	0402
18	1.6×0.8mm	0603
1M	1.37×1.0mm	0504
21	2.0×1.25mm	0805
22	2.8×2.8mm	1111
31	3.2×1.6mm	1206
32	3.2×2.5mm	1210
42	4.5×2.0mm	1808
43	4.5×3.2mm	1812
52	5.7×2.8mm	2211
55	5.7×5.0mm	2220

④ 厚度 (T)

代号	厚度 (T)
2	0.2mm
2	2单元 (排容型)
3	0.3mm
4	4单元 (排容型)
5	0.5mm
6	0.6mm
7	0.7mm
8	0.8mm
9	0.85mm
A	1.0mm
B	1.25mm
C	1.6mm
D	2.0mm
E	2.5mm
F	3.2mm
M	1.15mm
N	1.35mm
Q	1.5mm
R	1.8mm
S	2.8mm
X	按照个别规格规定。

关于排容型GNM系列，“厚度”表示单元个数。

接下页。

☐ 接上页。

⑤ 温度特性

温度特性代号			温度特性			动作温度范围
代号	共用标准代号		标准温度	温度范围	静电容量变化或温度系数	
1X	SL *1	JIS	20°C	20 to 85°C	+350 to -1000ppm/°C	-55 to 125°C
2C	CH *1	JIS	20°C	20 to 125°C	0±60ppm/°C	-55 to 125°C
2P	PH *1	JIS	20°C	20 to 85°C	-150±60ppm/°C	-25 to 85°C
2R	RH *1	JIS	20°C	20 to 85°C	-220±60ppm/°C	-25 to 85°C
2S	SH *1	JIS	20°C	20 to 85°C	-330±60ppm/°C	-25 to 85°C
2T	TH *1	JIS	20°C	20 to 85°C	-470±60ppm/°C	-25 to 85°C
3C	CJ *1	JIS	20°C	20 to 125°C	0±120ppm/°C	-55 to 125°C
3P	PJ *1	JIS	20°C	20 to 85°C	-150±120ppm/°C	-25 to 85°C
3R	RJ *1	JIS	20°C	20 to 85°C	-220±120ppm/°C	-25 to 85°C
3S	SJ *1	JIS	20°C	20 to 85°C	-330±120ppm/°C	-25 to 85°C
3T	TJ *1	JIS	20°C	20 to 85°C	-470±120ppm/°C	-25 to 85°C
3U	UJ *1	JIS	20°C	20 to 85°C	-750±120ppm/°C	-25 to 85°C
4C	CK *1	JIS	20°C	20 to 125°C	0±250ppm/°C	-55 to 125°C
5C	C0G *1	EIA	25°C	25 to 125°C	0±30ppm/°C	-55 to 125°C
5G	X8G *1	EIA	25°C	25 to 150°C	0±30ppm/°C	-55 to 150°C
6C	C0H *1	EIA	25°C	25 to 125°C	0±60ppm/°C	-55 to 125°C
6P	P2H *1	EIA	25°C	25 to 85°C	-150±60ppm/°C	-55 to 125°C
6R	R2H *1	EIA	25°C	25 to 85°C	-220±60ppm/°C	-55 to 125°C
6S	S2H *1	EIA	25°C	25 to 85°C	-330±60ppm/°C	-55 to 125°C
6T	T2H *1	EIA	25°C	25 to 85°C	-470±60ppm/°C	-55 to 125°C
7U	U2J *1	EIA	25°C	25 to 125°C *6	-750±120ppm/°C	-55 to 125°C
B1	B *2	JIS	20°C	-25 to 85°C	±10%	-25 to 85°C
B3	B	JIS	20°C	-25 to 85°C	±10%	-25 to 85°C
C7	X7S	EIA	25°C	-55 to 125°C	±22%	-55 to 125°C
C8	X6S	EIA	25°C	-55 to 105°C	±22%	-55 to 105°C
D7	X7T	EIA	25°C	-55 to 125°C	+22, -33%	-55 to 125°C
D8	X6T	EIA	25°C	-55 to 105°C	+22, -33%	-55 to 105°C
E7	X7U	EIA	25°C	-55 to 125°C	+22, -56%	-55 to 125°C
F1	F *2	JIS	20°C	-25 to 85°C	+30, -80%	-25 to 85°C
F5	Y5V	EIA	25°C	-30 to 85°C	+22, -82%	-30 to 85°C
L8	X8L *3		25°C	-55 to 150°C	+15, -40%	-55 to 150°C
R1	R *2	JIS	20°C	-55 to 125°C	±15%	-55 to 125°C
R3	R	JIS	20°C	-55 to 125°C	±15%	-55 to 125°C
R6	X5R	EIA	25°C	-55 to 85°C	±15%	-55 to 85°C
R7	X7R	EIA	25°C	-55 to 125°C	±15%	-55 to 125°C
R9	X8R	EIA	25°C	-55 to 150°C	±15%	-55 to 150°C
W0	-	-	25°C	-55 to 125°C	±10% *4	-55 to 125°C
					+22, -33% *5	

*1 请参阅标准温度下的静电容量变化表。

*2 增加额定电压的50%时有保证。

*3 Murata温度特性代号

*4 加DC350V偏压

*5 无DC偏压

*6 额定电压DC最高100V: 25到85°C

接下页。 ☐

☐ 接上页。

● 个别温度下的静电容量变化

JIS代号

Murata代号	以20°C (%) 为标准的静电容量变化					
	-55°C		-25°C		-10°C	
	最大值	最小值	最大值	最小值	最大值	最小值
1X	-	-	-	-	-	-
2C	0.82	-0.45	0.49	-0.27	0.33	-0.18
2P	-	-	1.32	0.41	0.88	0.27
2R	-	-	1.70	0.72	1.13	0.48
2S	-	-	2.30	1.22	1.54	0.81
2T	-	-	3.07	1.85	2.05	1.23
3C	1.37	-0.90	0.82	-0.54	0.55	-0.36
3P	-	-	1.65	0.14	1.10	0.09
3R	-	-	2.03	0.45	1.35	0.30
3S	-	-	2.63	0.95	1.76	0.63
3T	-	-	3.40	1.58	2.27	1.05
3U	-	-	4.94	2.84	3.29	1.89
4C	2.56	-1.88	1.54	-1.13	1.02	-0.75

EIA代号

Murata代号	以25°C (%) 为标准的静电容量变化					
	-55°C		-30°C		-10°C	
	最大值	最小值	最大值	最小值	最大值	最小值
5C/5G	0.58	-0.24	0.40	-0.17	0.25	-0.11
6C	0.87	-0.48	0.59	-0.33	0.38	-0.21
6P	2.33	0.72	1.61	0.50	1.02	0.32
6R	3.02	1.28	2.08	0.88	1.32	0.56
6S	4.09	2.16	2.81	1.49	1.79	0.95
6T	5.46	3.28	3.75	2.26	2.39	1.44
7U	8.78	5.04	6.04	3.47	3.84	2.21

接下页。 ☐

一旦您不能在目录上找到品名，请参见村田主页 (<http://www.murata.com/index.html>)。

☐ 接上页。

⑥ 额定电压

代号	额定电压
0E	DC2.5V
0G	DC4V
0J	DC6.3V
1A	DC10V
1C	DC16V
1E	DC25V
YA	DC35V
1H	DC50V
2A	DC100V
2D	DC200V
2E	DC250V
YD	DC300V
2H	DC500V
2J	DC630V
3A	DC1kV
3D	DC2kV
3F	DC3.15kV
BB	DC350V (照相机闪光电路用)
E2	AC250V
GB	X2; AC250V (安全规格认证品 GB型)
GC	X1/Y2; AC250V (安全规格认证品 GC型)
GD	Y3; AC250V (安全规格认证品 GD型)
GF	Y2, X1/Y2; AC250V (安全规格认证品 GF型)

⑦ 静电容量

由3位字母数字表示。单位为皮法 (pF)。第1位和第2位数字为有效数字，第3位数字表示有效数字后的0的个数。有小数点时以大写字母 "R" 表示。此时，所有数字均为有效数字。

例如)

代号	静电容量
R50	0.5pF
1R0	1.0pF
100	10pF
103	10000pF

接下页。 ☐

www.tocosc.com

接上页。

⑨ 静电容量允许偏差

代号	静电容量允许偏差	温度特性	系列	静电容量阶段	
W	±0.05pF	CΔ	GRM/GJM	≤9.9pF	0.1pF
			GRM/GJM	≤9.9pF	0.1pF
B	±0.1pF	CΔ	GQM	≤1pF	0.1pF
				1.1 to 9.9pF	1pF间隔和E24系列
			ERB	≤9.9pF	1pF间隔和E24系列
C	±0.25pF	CΔ	GRM/GJM	≤9.9pF	0.1pF
		CΔ以外	GRM	≤5pF	* 1pF
		CΔ	ERB	≤9.9pF	1pF间隔和E24系列
			GQM	≤1pF	0.1pF
D	±0.5pF	CΔ	GRM/GJM	5.1 to 9.9pF	0.1pF
		CΔ以外	GRM	5.1 to 9.9pF	* 1pF
		CΔ	ERB/GQM	5.1 to 9.9pF	1pF间隔和E24系列
G	±2%	CΔ	GJM	≥10pF	E12系列
		CΔ	GQM/ERB	≥10pF	E24系列
J	±5%	CΔ-SL	GRM/GA3	≥10pF	E12系列
		CΔ	ERB/GQM/GJM	≥10pF	E24系列
K	±10%	B, R, X7R, X5R, ZLM	GRM/GR7/GA3	E6系列	
		C0G	GNM	E6系列	
		B, R, X7R, X5R, ZLM	GR4, GMD	E12系列	
M	±20%	B, R, X7R, X7S	GRM/GMA	E6系列	
		X5R, X7R, X7S	GNM	E3系列	
		X7R	GA2	E3系列	
		X5R, X7R, X7S, X6S	LLL/LLA/LLM	E3系列	
Z	+80%, -20%	F, Y5V	GRM	E3系列	
R	由个别规格来规定。				

* E24系列也可以提供。

⑩ 个别规格代号

由3位数字表示。

⑪ 包装

代号	包装
L	φ180mm 压纹带
D	φ180mm 纸带
E	φ180mm 纸带 (LLL15)
K	φ330mm 压纹带
J	φ330mm 纸带
F	φ330mm 纸带 (LLL15)
B	散装袋
C	散装盒
T	浅盘

一旦您不能在目录上找到品名，请参见村田主页 (<http://www.murata.com/index.html>)。

片状独石陶瓷电容器选择指南

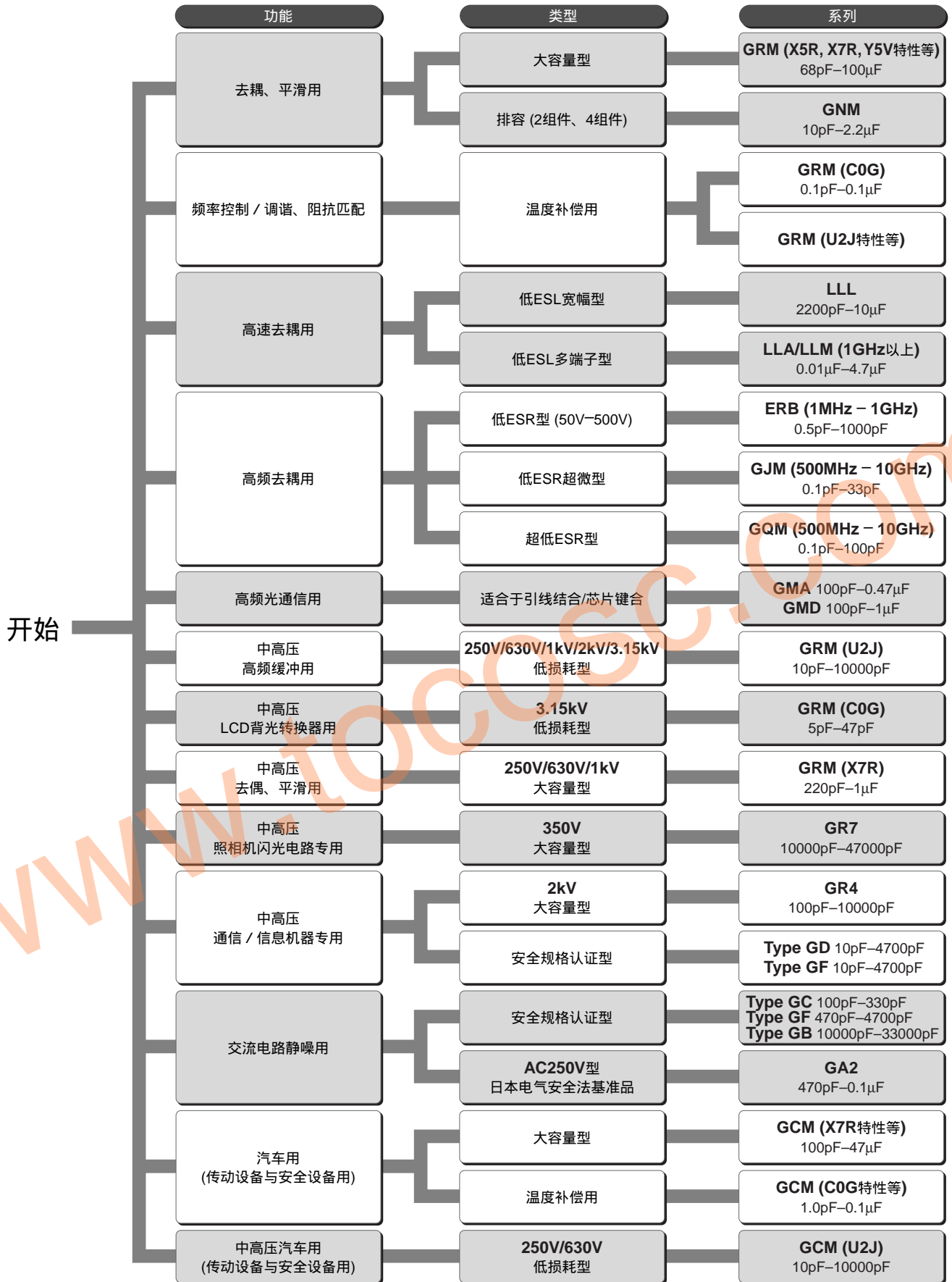

片状独石陶瓷电容器



一般用GRM系列

特点

1. 镍隔层使外部电极具有更好的耐热性，适用于回流焊接和波峰焊接 (仅限GRM18/21/31型)。
2. 尺寸更小，静电容量值更高。
3. 可靠性高，无极性。
4. 高频时低阻抗使冲激响应及降噪效果出众。
5. GRM系列用纸带或压纹带及卷装包装，可进行自动贴装。
GRM15/18/21(T = 0.6, 1.25) 也使用散装盒包装。
6. Ta替换。

用途

一般电子机器用

Part Number	Dimensions (mm)				
	L	W	T	e	g min.
GRM022	0.4 ±0.02	0.2 ±0.02	0.2 ±0.02	0.07 to 0.14	0.13
GRM033	0.6 ±0.03	0.3 ±0.03	0.3 ±0.03	0.1 to 0.2	0.2
GRM15X	1.0 ±0.05	0.5 ±0.05	0.25 ±0.05	0.1 to 0.3	0.4
GRM153			0.3 ±0.03		
GRM155	1.6 ±0.1	0.8 ±0.1	0.5 ±0.05	0.15 to 0.35	0.3
GRM185			0.8 ±0.1		
GRM188*	2.0 ±0.1	1.25 ±0.1	0.6 ±0.1	0.2 to 0.7	0.7
GRM216			0.85 ±0.1		
GRM219	3.2 ±0.15	1.6 ±0.15	1.0 ±0/-0.2	0.3 to 0.8	1.5
GRM21A			1.25 ±0.1		
GRM21B	3.2 ±0.2	1.6 ±0.2	1.25 ±0.1	0.3 min.	1.0
GRM316			0.6 ±0.1		
GRM319	3.2 ±0.3	2.5 ±0.2	0.85 ±0.1	0.3 min.	1.0
GRM31M			1.15 ±0.1		
GRM31C	3.2 ±0.3	2.5 ±0.2	1.6 ±0.2	0.3 min.	1.0
GRM329			0.85 ±0.15/-0.05		
GRM32A	3.2 ±0.3	2.5 ±0.2	1.0 ±0/-0.2	0.3 min.	1.0
GRM32M			1.15 ±0.1		
GRM32N	3.2 ±0.3	2.5 ±0.2	1.35 ±0.15	0.3 min.	1.0
GRM32C			1.6 ±0.2		
GRM32R	3.2 ±0.3	2.5 ±0.2	1.8 ±0.2	0.3 min.	1.0
GRM32D			2.0 ±0.2		
GRM32E	3.2 ±0.3	2.5 ±0.2	2.5 ±0.2	0.3 min.	1.0
GRM32E			2.5 ±0.2		

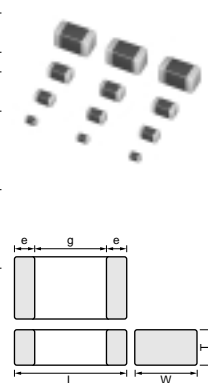

* Bulk Case: 1.6 ±0.07(L) × 0.8 ±0.07(W) × 0.8 ±0.07(T)
 * The figure indicates typical Specification.

www.tocosc.com

温度补偿型 C0G(5C),U2J(7U) 特性

6 例 6: 厚度 [mm]		C0G(5C)										U2J(7U)											
TC代号	长x宽 [mm]	0.4x0.2 (02) <01005>		0.6x0.3 (03) <0201>		1.0x0.5 (15) <0402>		1.6x0.8 (18) <0603>		2.0x1.25 (21) <0805>		3.2x1.6 (31) <1206>		0.6x0.3 (03) <0201>		1.0x0.5 (15) <0402>		1.6x0.8 (18) <0603>		2.0x1.25 (21) <0805>		3.2x1.6 (31) <1206>	
		16 (1C)	10 (1A)	6.3 (0J)	50 (1H)	50 (1H)	100 (1E)	50 (1H)	100 (1E)	50 (1H)	100 (1E)	50 (1H)	50 (1H)	25 (1E)	50 (1H)	10 (1A)	50 (1H)	10 (1A)	50 (1H)	10 (1A)	50 (1H)	10 (1A)	50 (1H)
静电容量	[Vdc]																						
0.1pF(R10)																							
0.2pF(R20)	2																						
0.3pF(R30)	2																						
0.4pF(R40)	2																						
0.5pF(R50)	2																						
0.6pF(R60)	2																						
0.7pF(R70)	2																						
0.8pF(R80)	2																						
0.9pF(R90)	2																						
1.0pF(1R0)	2																						
1.1pF(1R1)	2																						
1.2pF(1R2)	2																						
1.3pF(1R3)	2																						
1.4pF(1R4)	2																						
1.5pF(1R5)	2																						
1.6pF(1R6)	2																						
1.7pF(1R7)	2																						
1.8pF(1R8)	2																						
1.9pF(1R9)	2																						
2.0pF(2R0)	2																						
2.1pF(2R1)	2																						
2.2pF(2R2)	2																						
2.3pF(2R3)	2																						
2.4pF(2R4)	2																						
2.5pF(2R5)	2																						
2.6pF(2R6)	2																						
2.7pF(2R7)	2																						
2.8pF(2R8)	2																						
2.9pF(2R9)	2																						
3.0pF(3R0)	2																						
3.1pF(3R1)	2																						
3.2pF(3R2)	2																						
3.3pF(3R3)	2																						
3.4pF(3R4)	2																						
3.5pF(3R5)	2																						
3.6pF(3R6)	2																						
3.7pF(3R7)	2																						
3.8pF(3R8)	2																						
3.9pF(3R9)	2																						
4.0pF(4R0)	2																						
4.1pF(4R1)	2																						
4.2pF(4R2)	2																						
4.3pF(4R3)	2																						
4.4pF(4R4)	2																						
4.5pF(4R5)	2																						
4.6pF(4R6)	2																						
4.7pF(4R7)	2																						
4.8pF(4R8)	2																						
4.9pF(4R9)	2																						

品名代号在()中注明，单位在 []中注明。< >: EIA [英寸] 代号

电容表

☐ 接上页

6 例) 6: 厚度 [mm]

TC代号 长x宽 [mm] 额定电压 [Vdc] 静电容量	C0G(5C)										U2J(7U)									
	0.4x0.2 (02) <01005>			0.6x0.3 (03) <0201>	1.0x0.5 (15) <0402>	1.6x0.8 (18) <0603>		2.0x1.25 (21) <0805>		3.2x1.6 (31) <1206>		0.6x0.3 (03) <0201>		1.0x0.5 (15) <0402>		1.6x0.8 (18) <0603>		2.0x1.25 (21) <0805>		3.2x1.6 (31) <1206>
	16 (1C)	10 (1A)	6.3 (0J)	50 (1H)	50 (1H)	100 (1E)	50 (1H)	100 (1E)	50 (1H)	100 (1E)	50 (1H)	50 (1H)	25 (1E)	50 (1H)	10 (1A)	50 (1H)	10 (1A)	50 (1H)	10 (1A)	50 (1H)
5.0pF(5R0)	2			3	3, 5							3		5						
5.1pF(5R1)	2			3	3, 5															
5.2pF(5R2)	2			3	3, 5															
5.3pF(5R3)	2			3	3, 5															
5.4pF(5R4)	2			3	3, 5															
5.5pF(5R5)	2			3	3, 5															
5.6pF(5R6)	2			3	3, 5															
5.7pF(5R7)	2			3	3, 5															
5.8pF(5R8)	2			3	3, 5															
5.9pF(5R9)	2			3	3, 5															
6.0pF(6R0)	2			3	3, 5							3		5						
6.1pF(6R1)	2			3	3, 5															
6.2pF(6R2)	2			3	3, 5															
6.3pF(6R3)	2			3	3, 5															
6.4pF(6R4)	2			3	3, 5															
6.5pF(6R5)	2			3	3, 5															
6.6pF(6R6)	2			3	3, 5															
6.7pF(6R7)	2			3	3, 5															
6.8pF(6R8)	2			3	3, 5															
6.9pF(6R9)	2			3	3, 5															
7.0pF(7R0)	2			3	3, 5							3		5						
7.1pF(7R1)	2			3	3, 5															
7.2pF(7R2)	2			3	3, 5															
7.3pF(7R3)	2			3	3, 5															
7.4pF(7R4)	2			3	3, 5															
7.5pF(7R5)	2			3	3, 5															
7.6pF(7R6)	2			3	3, 5															
7.7pF(7R7)	2			3	3, 5															
7.8pF(7R8)	2			3	3, 5															
7.9pF(7R9)	2			3	3, 5															
8.0pF(8R0)	2			3	3, 5							3		5						
8.1pF(8R1)	2			3	3, 5															
8.2pF(8R2)	2			3	3, 5															
8.3pF(8R3)	2			3	3, 5															
8.4pF(8R4)	2			3	3, 5															
8.5pF(8R5)	2			3	3, 5															
8.6pF(8R6)	2			3	3, 5															
8.7pF(8R7)	2			3	3, 5															
8.8pF(8R8)	2			3	3, 5															
8.9pF(8R9)	2			3	3, 5															
9.0pF(9R0)	2			3	3, 5							3		5						
9.1pF(9R1)	2			3	3, 5															
9.2pF(9R2)	2			3	3, 5															
9.3pF(9R3)	2			3	3, 5															
9.4pF(9R4)	2			3	3, 5															
9.5pF(9R5)	2			3	3, 5															
9.6pF(9R6)	2			3	3, 5															
9.7pF(9R7)	2			3	3, 5															
9.8pF(9R8)	2			3	3, 5															
9.9pF(9R9)	2			3	3, 5															

品名代号在()中注明，单位在 []中注明。< >: EIA [英寸] 代号

接下一页。 ☐

电容表

接上页

6 例) 6: 厚度 [mm]		C0G(5C)										U2J(7U)									
TC代号	长x宽 [mm]	0.4x0.2 (02) <01005>			0.6x0.3 (03) (15) <0201><0402>		1.6x0.8 (18) <0603>		2.0x1.25 (21) <0805>		3.2x1.6 (31) <1206>		0.6x0.3 (03) <0201>		1.0x0.5 (15) <0402>		1.6x0.8 (18) <0603>		2.0x1.25 (21) <0805>		3.2x1.6 (31) <1206>
		16 (1C)	10 (1A)	6.3 (0J)	50 (1H)	50 (1H)	100 (1E)	50 (1H)	100 (1E)	50 (1H)	100 (1E)	50 (1H)	50 (1H)	25 (1E)	50 (1H)	10 (1A)	50 (1H)	10 (1A)	50 (1H)	10 (1A)	50 (1H)
10pF(100)	2				3	3,5	8	8					3			5					
12pF(120)	2				3	3,5	8	8					3			5					
15pF(150)	2				3	3,5	8	8					3			5					
18pF(180)	2				3	3,5	8	8						3		5					
22pF(220)	2				3	3,5	8	8						3		5					
27pF(270)	2				3	3,5	8	8						3		5					
33pF(330)	2				3	3,5	8	8						3		5					
39pF(390)	2				3	3,5	8	8						3		5					
47pF(470)	2				3	3,5	8	8						3		5					
56pF(560)		2	2		3	3,5	8	8						3		5					
68pF(680)		2	2		3	3,5	8	8						3		5					
82pF(820)		2	2		3	3,5	8	8						3		5					
100pF(101)		2	2		3	3,5	8	8	6					3		5					
120pF(121)						3,5	8	8	6							5					
150pF(151)						3,5	8	8	6							5					
180pF(181)						3,5	8	8	6							5					
220pF(221)						3,5	8	8	6												
270pF(271)						3,5	8	8	6												
330pF(331)						3,5	8	8	6												
390pF(391)						3,5	8	8	6												
470pF(471)						3,5	8	8	6												
560pF(561)						3,5	8	8	6												
680pF(681)						3,5	8	8	6												
820pF(821)						5	8	8	6												
1000pF(102)						5	8	8	6								8				
1200pF(122)						8	8	6	6							5	8				
1500pF(152)						8	8	6	6							5	8				
1800pF(182)						8	6	6	9							5	8				
2200pF(222)						8	6	6	9							5	5,8				
2700pF(272)						8	6	6	9							5	5,8				
3300pF(332)						8	6	6	9							5	5,8				
3900pF(392)						8										5	5,8				
4700pF(472)								6	9	9						5	5,8				
5600pF(562)								9	9	9						8	5				
6800pF(682)								9	9	9						8	5				
8200pF(822)								9	9	9						8	5				
10000pF(103)								9	9	9						8	5	6			
12000pF(123)								9		9							8	6			
15000pF(153)								9		9							8	6			
18000pF(183)								B		9							8	6			
22000pF(223)								B		9							8	9			
27000pF(273)										9								9			
33000pF(333)										9								A			
39000pF(393)										9								B			
47000pF(473)										M								B			
56000pF(563)										M									9	9	
68000pF(683)										C									B	M	
82000pF(823)										C									B	M	
0.1μF(104)										C									B	M	

品名代号在()中注明，单位在[]中注明。< >: EIA [英寸] 代号

接下页

电容表

☐ 接上页

温度补偿型 P2H(6P),R2H(6R),S2H(6S),T2H(6T) 特性

6		例) 6: 厚度 [mm]							
TC代号	长x宽 [mm]	P2H (6P)		R2H (6R)		S2H (6S)		T2H (6T)	
		1.0x0.5 (15) <0402>	0.6x0.3 (03) <0201>	1.0x0.5 (15) <0402>	0.6x0.3 (03) <0201>	1.0x0.5 (15) <0402>	0.6x0.3 (03) <0201>	1.0x0.5 (15) <0402>	0.6x0.3 (03) <0201>
额定电压 [Vdc]		50 (1H)	25 (1E)	50 (1H)	25 (1E)	50 (1H)	25 (1E)	50 (1H)	25 (1E)
静电容量	1.0pF(1R0)	5	3	5	3	5	3	5	5
	2.0pF(2R0)	5	3	5	3	5	3	5	5
	3.0pF(3R0)	5	3	5	3	5	3	5	5
	4.0pF(4R0)	5	3	5	3	5	3	5	5
	5.0pF(5R0)	5	3	5	3	5	3	5	5
	6.0pF(6R0)	5	3	5	3	5	3	5	5
	7.0pF(7R0)	5	3	5	3	5	3	5	5
	8.0pF(8R0)	5	3	5	3	5	3	5	5
	9.0pF(9R0)	5	3	5	3	5	3	5	5
	10pF(100)	5	3	5	3	5	3	5	5
	12pF(120)	5	3	5	3	5	3	5	5
	15pF(150)	5	3	5	3	5	3	5	5
	18pF(180)	5	3	5	3	5	3	5	5
	22pF(220)	5	3	5	3	5	3	5	5
	27pF(270)	5	3	5	3	5	3	5	5
	33pF(330)		3	5	3	5	3	5	5
	39pF(390)		3		3	5	3	5	5
	47pF(470)		3		3		3	5	5
	56pF(560)		3		3		3	5	5
	68pF(680)		3		3		3	5	5
	82pF(820)		3		3		3	5	5
	100pF(101)		3		3		3	5	5

品名代号在()中注明，单位在 []中注明。< >: EIA [英寸] 代号

接下页。 ☐

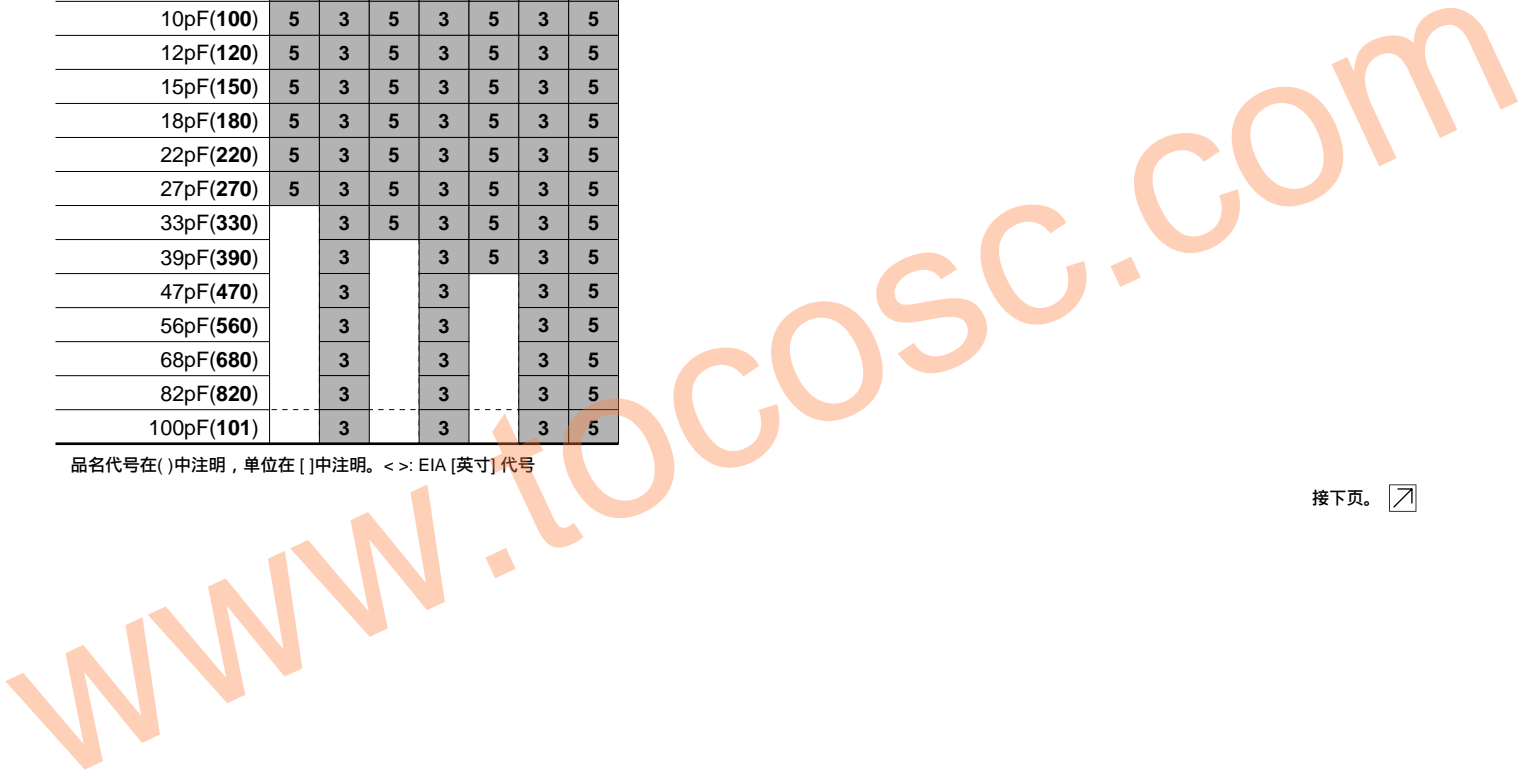

接上页

高介电常数型 X7R(R7)/X7S(C7)/X7T(D7)/X7U(E7) 特性

长x宽 [mm]	0.4x0.2 (02) <D1005>				0.6x0.3 (03) <0201>				1.0x0.5 (15) <0402>					1.6x0.8 (18) <0603>						2.0x1.25 (21) <0805>					
	10 (1A)	25 (1E)	16 (1C)	10 (1A)	100 (2A)	50 (1H)	25 (1E)	16 (1C)	10 (1A)	100 (2A)	50 (1H)	25 (1E)	16 (1C)	10 (1A)	6.3 (0J)	4 (0G)	100 (2A)	50 (1H)	25 (1E)	16 (1C)	10 (1A)	6.3 (0J)	4 (0G)		
静电容量 [Vdc]																									
68pF(680)	2																								
100pF(101)	2	3																							
150pF(151)	2	3																							
220pF(221)	2	3			5	X, 5			8	8															
330pF(331)	2	3			5	X, 5			8	8															
470pF(471)	2	3			5	X, 5			8	8															
680pF(681)		3			5	X, 5			8	8															
1000pF(102)		3			5	X, 5			8	8															
1500pF(152)		3			5	X, 5			8	8															
2200pF(222)			3		5	5	X		8	8															
3300pF(332)			3		5	5		X	8	8															
4700pF(472)				3	5	5	5	X	8	8															
6800pF(682)				3	5	5		X	8	8															
10000pF(103)				3	5	5		X	8	8	8										9				
15000pF(153)					5	5	5		8	8											B				
22000pF(223)					5	5	5		8	8											B				
33000pF(333)					5	5			8	8											B	9			
47000pF(473)					5	5			8	8											B	B			
68000pF(683)					5	5			8	8											B	9			
0.10μF(104)					5	5			8	8	8										B	B			
0.15μF(154)									8	8		8									B	B			
0.22μF(224)									8	8		8	8								A	B	B		
0.33μF(334)									8	8		8	8								A	9	B		
0.47μF(474)									8	8		8	8								B	B	9		
0.68μF(684)												8										9	9		
1.0μF(105)									8	8		5, 8									B	9, B	B		
2.2μF(225)												8	8	8								B	B	B	
4.7μF(475)																							B	B	
10μF(106)																							B	B	
22μF(226)																								B	

长x宽 [mm]	3.2x1.6 (31) <1206>						3.2x2.5 (32) <1210>							
	100 (2A)	50 (1H)	25 (1E)	16 (1C)	10 (1A)	6.3 (0J)	4 (0G)	100 (2A)	50 (1H)	35 (YA)	25 (1E)	16 (1C)	10 (1A)	6.3 (0J)
静电容量 [Vdc]														
15000pF(153)	9													
22000pF(223)	M													
33000pF(333)	M													
47000pF(473)	M													
68000pF(683)	M													
0.10μF(104)	9													
0.15μF(154)	M	M												
0.22μF(224)	M	M												
0.33μF(334)			9											
0.47μF(474)	M	M												
0.68μF(684)	M	M					C	N						
1.0μF(105)	C	M					C							
2.2μF(225)		C	M	M			E							
4.7μF(475)		C	C	C				E						
10μF(106)			C	C	C				E	D				
22μF(226)				C	C					E	E			
47μF(476)						C						E	E	

品名代号在()中注明，单位在 []中注明。<->: EIA [英寸] 代号

接下一页

电容表

☐ 接上页

高介电常数型 X6S(C8)/X6T(D8) 特性

长x宽 [mm]	0.6x0.3 (03) <0201>		1.0x0.5 (15) <0402>		1.6x0.8 (18) <0603>				2.0x1.25 (21) <0805>				3.2x1.6 (31) <1206>				3.2x2.5 (32) <1210>				
	6.3 (0J)	25 (1E)	6.3 (0J)	4 (0G)	10 (1A)	6.3 (0J)	4 (0G)	2.5 (0E)	25 (1E)	16 (1C)	10 (1A)	6.3 (0J)	4 (0G)	25 (1E)	16 (1C)	10 (1A)	6.3 (0J)	4 (0G)	25 (1E)	10 (1A)	6.3 (0J)
静电容量 [Vdc]																					
15000pF(153)	3																				
22000pF(223)	3																				
33000pF(333)	3																				
47000pF(473)	3																				
68000pF(683)		5																			
0.10μF(104)		5																			
0.15μF(154)			5	5																	
0.22μF(224)			5	5																	
0.33μF(334)			5	5																	
0.47μF(474)			5	5																	
0.68μF(684)				5																	
1.0μF(105)					5	5	8			6											
2.2μF(225)					8	8				9											
4.7μF(475)							8		B	B	9	9									
10μF(106)								8			B	9, B	9	C							
22μF(226)															C	C		D			
47μF(476)																C	C		E	E	
100μF(107)																	C				

品名代号在()中注明，单位在 []中注明。< >: EIA [英寸] 代号

接下页。 ☐

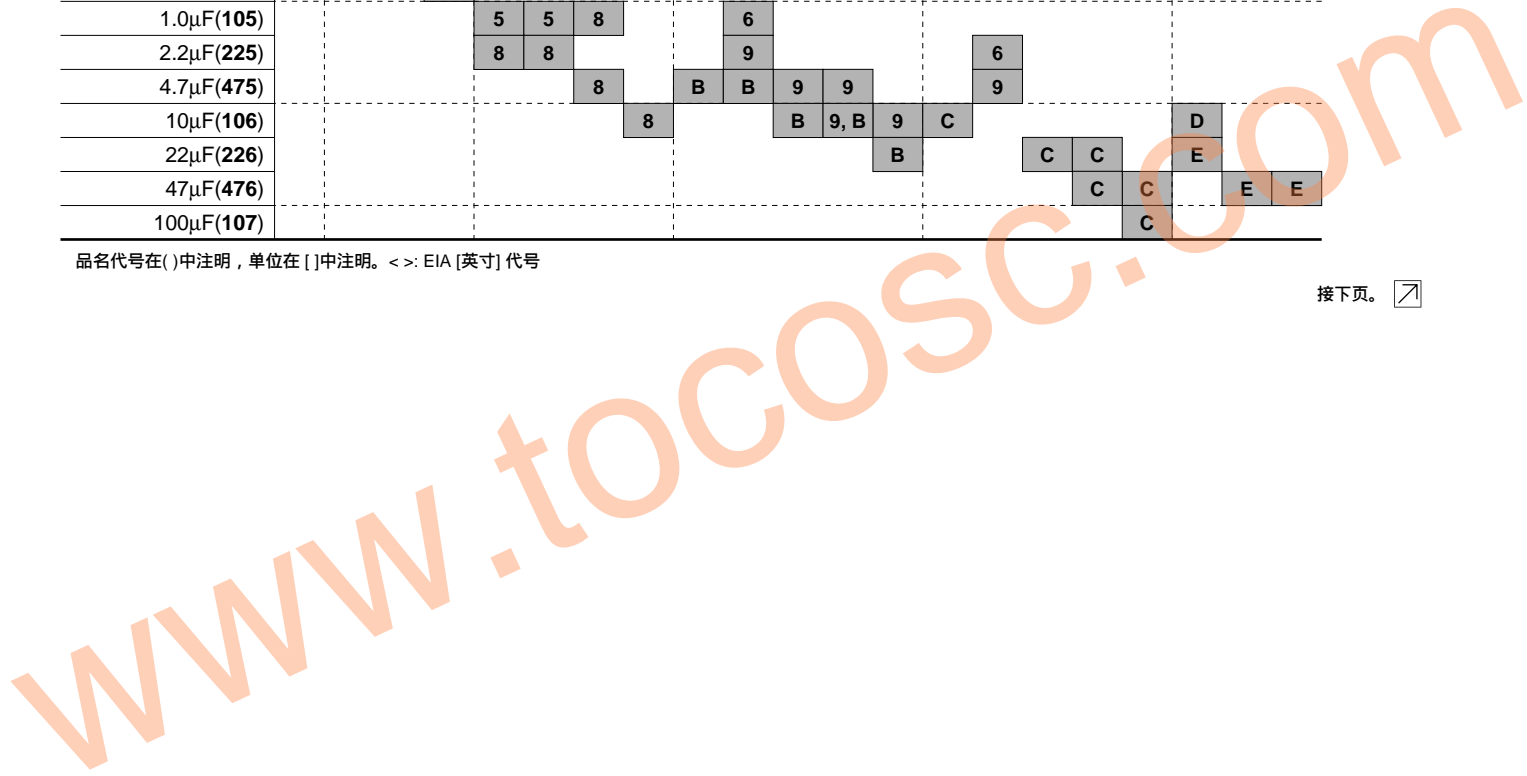

☐ 接上页

高介电常数型 X5R(R6) 特性

例 5: 厚度 [mm] : 请参见X7R (R7) 等的特性。

长x宽 [mm]	0.4x0.2 (02) <01005>		0.6x0.3 (03) <0201>				1.0x0.5 (15) <0402>								1.6x0.8 (18) <0603>							
	10 (1A)	6.3 (0J)	25 (1E)	16 (1C)	10 (1A)	6.3 (0J)	100 (2A)	50 (1H)	25 (1E)	16 (1C)	10 (1A)	6.3 (0J)	4 (0G)	100 (2A)	50 (1H)	25 (1E)	16 (1C)	10 (1A)	6.3 (0J)	4 (0G)		
静电容量 [Vdc]																						
68pF(680)	2																					
100pF(101)	2																					
150pF(151)	2																					
220pF(221)	2																					
330pF(331)	2																					
470pF(471)	2																					
680pF(681)		2																				
1000pF(102)		2						5								8						
1500pF(152)		2			3																	
2200pF(222)		2			3			5								8						
3300pF(332)		2			3																	
4700pF(472)		2			3			5								8						
6800pF(682)		2			3																	
10000pF(103)		2			3											8						
15000pF(153)						3																
22000pF(223)						3										8						
33000pF(333)						3				5	5											
47000pF(473)						3				5	5											
68000pF(683)										5	5	5										
0.10μF(104)										5	5	5				8	8					
0.15μF(154)											5	5						8				
0.22μF(224)											5	5				8	8	8				
0.33μF(334)											5	5										
0.47μF(474)											5	5				8	8	8				
0.68μF(684)											5	5										
1.0μF(105)											5					8	5, 8	5				
2.2μF(225)																	8	8				
4.7μF(475)													5							8		
10μF(106)																				8	8	

长x宽 [mm]	2.0x1.25 (21) <0805>							3.2x1.6 (31) <1206>							3.2x2.5 (32) <1210>							
	100 (2A)	50 (1H)	25 (1E)	16 (1C)	10 (1A)	6.3 (0J)	4 (0G)	100 (2A)	50 (1H)	25 (1E)	16 (1C)	10 (1A)	6.3 (0J)	4 (0G)	100 (2A)	50 (1H)	35 (YA)	25 (1E)	16 (1C)	10 (1A)	6.3 (0J)	
静电容量 [Vdc]																						
6800pF(682)																						
10000pF(103)																						
15000pF(153)																						
22000pF(223)																						
33000pF(333)																						
47000pF(473)																						
68000pF(683)																						
0.10μF(104)																						
0.15μF(154)																						
0.22μF(224)																						
0.33μF(334)						B																
0.47μF(474)						B																
0.68μF(684)																						
1.0μF(105)			6	B																		
2.2μF(225)			9, B	9, B	B					C	6											
4.7μF(475)			B	9, B	9						9, C	9, C										
10μF(106)				B	9, B	9					C	9, C	9					E	D			
22μF(226)						B	9					C	C	C					E			
47μF(476)														C						E	E	
100μF(107)														C	C							

品名代号在()中注明, 单位在 []中注明。 < >: EIA [英寸] 代号

温度补偿型 C0G(5C) 特性

长x宽 [mm]		0.4x0.2(02)<01005>	0.6x0.3(03)<0201>	1.0x0.5(15)<0402>
额定电压 [Vdc]		16(1C)	50(1H)	50(1H)
静电容量	公差	品名		
0.1pF(R10)	±0.05pF(W)		GRM0335C1HR10WD01D	GRM1555C1HR10WA01D
	±0.1pF(B)		GRM0335C1HR10BD01D	GRM1555C1HR10BA01D
0.2pF(R20)	±0.05pF(W)	GRM0225C1CR20WD05L	GRM0335C1HR20WD01D	GRM1555C1HR20WA01D
	±0.1pF(B)	GRM0225C1CR20BD05L	GRM0335C1HR20BD01D	GRM1555C1HR20BA01D
0.3pF(R30)	±0.05pF(W)	GRM0225C1CR30WD05L	GRM0335C1HR30WD01D	GRM1555C1HR30WA01D
	±0.1pF(B)	GRM0225C1CR30BD05L	GRM0335C1HR30BD01D	GRM1555C1HR30BA01D
0.4pF(R40)	±0.05pF(W)	GRM0225C1CR40WD05L	GRM0335C1HR40WD01D	GRM1555C1HR40WA01D
	±0.1pF(B)	GRM0225C1CR40BD05L	GRM0335C1HR40BD01D	GRM1555C1HR40BA01D
0.5pF(R50)	±0.05pF(W)	GRM0225C1CR50WD05L	GRM0335C1HR50WD01D	GRM1555C1HR50WA01D
	±0.1pF(B)	GRM0225C1CR50BD05L	GRM0335C1HR50BD01D	GRM1555C1HR50BA01D
0.6pF(R60)	±0.05pF(W)	GRM0225C1CR60WD05L	GRM0335C1HR60WD01D	GRM1555C1HR60WA01D
	±0.1pF(B)	GRM0225C1CR60BD05L	GRM0335C1HR60BD01D	GRM1555C1HR60BA01D
0.7pF(R70)	±0.05pF(W)	GRM0225C1CR70WD05L	GRM0335C1HR70WD01D	GRM1555C1HR70WA01D
	±0.1pF(B)	GRM0225C1CR70BD05L	GRM0335C1HR70BD01D	GRM1555C1HR70BA01D
0.8pF(R80)	±0.05pF(W)	GRM0225C1CR80WD05L	GRM0335C1HR80WD01D	GRM1555C1HR80WA01D
	±0.1pF(B)	GRM0225C1CR80BD05L	GRM0335C1HR80BD01D	GRM1555C1HR80BA01D
0.9pF(R90)	±0.05pF(W)	GRM0225C1CR90WD05L	GRM0335C1HR90WD01D	GRM1555C1HR90WA01D
	±0.1pF(B)	GRM0225C1CR90BD05L	GRM0335C1HR90BD01D	GRM1555C1HR90BA01D
1.0pF(1R0)	±0.05pF(W)	GRM0225C1C1R0WD05L	GRM0335C1H1R0WD01D	GRM1555C1H1R0WA01D
	±0.1pF(B)	GRM0225C1C1R0BD05L	GRM0335C1H1R0BD01D	GRM1555C1H1R0BA01D
	±0.25pF(C)	GRM0225C1C1R0CD05L	GRM0335C1H1R0CD01D	GRM1555C1H1R0CA01D
1.1pF(1R1)	±0.05pF(W)	GRM0225C1C1R1WD05L	GRM0335C1H1R1WD01D	GRM1555C1H1R1WA01D
	±0.1pF(B)	GRM0225C1C1R1BD05L	GRM0335C1H1R1BD01D	GRM1555C1H1R1BA01D
	±0.25pF(C)	GRM0225C1C1R1CD05L	GRM0335C1H1R1CD01D	GRM1555C1H1R1CA01D
1.2pF(1R2)	±0.05pF(W)	GRM0225C1C1R2WD05L	GRM0335C1H1R2WD01D	GRM1555C1H1R2WA01D
	±0.1pF(B)	GRM0225C1C1R2BD05L	GRM0335C1H1R2BD01D	GRM1555C1H1R2BA01D
	±0.25pF(C)	GRM0225C1C1R2CD05L	GRM0335C1H1R2CD01D	GRM1555C1H1R2CA01D
1.3pF(1R3)	±0.05pF(W)	GRM0225C1C1R3WD05L	GRM0335C1H1R3WD01D	GRM1555C1H1R3WA01D
	±0.1pF(B)	GRM0225C1C1R3BD05L	GRM0335C1H1R3BD01D	GRM1555C1H1R3BA01D
	±0.25pF(C)	GRM0225C1C1R3CD05L	GRM0335C1H1R3CD01D	GRM1555C1H1R3CA01D
1.4pF(1R4)	±0.05pF(W)	GRM0225C1C1R4WD05L	GRM0335C1H1R4WD01D	GRM1555C1H1R4WA01D
	±0.1pF(B)	GRM0225C1C1R4BD05L	GRM0335C1H1R4BD01D	GRM1555C1H1R4BA01D
	±0.25pF(C)	GRM0225C1C1R4CD05L	GRM0335C1H1R4CD01D	GRM1555C1H1R4CA01D
1.5pF(1R5)	±0.05pF(W)	GRM0225C1C1R5WD05L	GRM0335C1H1R5WD01D	GRM1555C1H1R5WA01D
	±0.1pF(B)	GRM0225C1C1R5BD05L	GRM0335C1H1R5BD01D	GRM1555C1H1R5BA01D
	±0.25pF(C)	GRM0225C1C1R5CD05L	GRM0335C1H1R5CD01D	GRM1555C1H1R5CA01D
1.6pF(1R6)	±0.05pF(W)	GRM0225C1C1R6WD05L	GRM0335C1H1R6WD01D	GRM1555C1H1R6WA01D
	±0.1pF(B)	GRM0225C1C1R6BD05L	GRM0335C1H1R6BD01D	GRM1555C1H1R6BA01D
	±0.25pF(C)	GRM0225C1C1R6CD05L	GRM0335C1H1R6CD01D	GRM1555C1H1R6CA01D
1.7pF(1R7)	±0.05pF(W)	GRM0225C1C1R7WD05L	GRM0335C1H1R7WD01D	GRM1555C1H1R7WA01D
	±0.1pF(B)	GRM0225C1C1R7BD05L	GRM0335C1H1R7BD01D	GRM1555C1H1R7BA01D
	±0.25pF(C)	GRM0225C1C1R7CD05L	GRM0335C1H1R7CD01D	GRM1555C1H1R7CA01D
1.8pF(1R8)	±0.05pF(W)	GRM0225C1C1R8WD05L	GRM0335C1H1R8WD01D	GRM1555C1H1R8WA01D
	±0.1pF(B)	GRM0225C1C1R8BD05L	GRM0335C1H1R8BD01D	GRM1555C1H1R8BA01D
	±0.25pF(C)	GRM0225C1C1R8CD05L	GRM0335C1H1R8CD01D	GRM1555C1H1R8CA01D
1.9pF(1R9)	±0.05pF(W)	GRM0225C1C1R9WD05L	GRM0335C1H1R9WD01D	GRM1555C1H1R9WA01D
	±0.1pF(B)	GRM0225C1C1R9BD05L	GRM0335C1H1R9BD01D	GRM1555C1H1R9BA01D
	±0.25pF(C)	GRM0225C1C1R9CD05L	GRM0335C1H1R9CD01D	GRM1555C1H1R9CA01D
2.0pF(2R0)	±0.05pF(W)	GRM0225C1C2R0WD05L	GRM0335C1H2R0WD01D	GRM1555C1H2R0WA01D
	±0.1pF(B)	GRM0225C1C2R0BD05L	GRM0335C1H2R0BD01D	GRM1555C1H2R0BA01D
	±0.25pF(C)	GRM0225C1C2R0CD05L	GRM0335C1H2R0CD01D	GRM1555C1H2R0CA01D

品名代号在()中注明，单位在 []中注明。< >: EIA [英寸] 代号

- (品名) GR M 02 2 5C 1C R20 W D05 L ①型号 ②系列 ③尺寸(长×宽) ④尺寸(厚度) ⑤温度特性
 ⑥额定电压 ⑦静电容量 ⑧静电容量公差 ⑨个别规格代号 ⑩包装*

品名中的包装代号表示标准180mm卷盘。

*GRM022: 可适用D代码包装方式。

温度补偿型 C0G(5C) 特性

长x宽 [mm]		0.4x0.2(02)<01005>	0.6x0.3(03)<0201>	1.0x0.5(15)<0402>
额定电压 [Vdc]		16(1C)	50(1H)	50(1H)
静电容量	公差	品名		
2.1pF(2R1)	±0.05pF(W)	GRM0225C1C2R1WD05L	GRM0335C1H2R1WD01D	GRM1555C1H2R1WA01D
	±0.1pF(B)	GRM0225C1C2R1BD05L	GRM0335C1H2R1BD01D	GRM1555C1H2R1BA01D
	±0.25pF(C)	GRM0225C1C2R1CD05L	GRM0335C1H2R1CD01D	GRM1555C1H2R1CA01D
2.2pF(2R2)	±0.05pF(W)	GRM0225C1C2R2WD05L	GRM0335C1H2R2WD01D	GRM1555C1H2R2WA01D
	±0.1pF(B)	GRM0225C1C2R2BD05L	GRM0335C1H2R2BD01D	GRM1555C1H2R2BA01D
	±0.25pF(C)	GRM0225C1C2R2CD05L	GRM0335C1H2R2CD01D	GRM1555C1H2R2CA01D
2.3pF(2R3)	±0.05pF(W)	GRM0225C1C2R3WD05L	GRM0335C1H2R3WD01D	GRM1555C1H2R3WA01D
	±0.1pF(B)	GRM0225C1C2R3BD05L	GRM0335C1H2R3BD01D	GRM1555C1H2R3BA01D
	±0.25pF(C)	GRM0225C1C2R3CD05L	GRM0335C1H2R3CD01D	GRM1555C1H2R3CA01D
2.4pF(2R4)	±0.05pF(W)	GRM0225C1C2R4WD05L	GRM0335C1H2R4WD01D	GRM1555C1H2R4WA01D
	±0.1pF(B)	GRM0225C1C2R4BD05L	GRM0335C1H2R4BD01D	GRM1555C1H2R4BA01D
	±0.25pF(C)	GRM0225C1C2R4CD05L	GRM0335C1H2R4CD01D	GRM1555C1H2R4CA01D
2.5pF(2R5)	±0.05pF(W)	GRM0225C1C2R5WD05L	GRM0335C1H2R5WD01D	GRM1555C1H2R5WA01D
	±0.1pF(B)	GRM0225C1C2R5BD05L	GRM0335C1H2R5BD01D	GRM1555C1H2R5BA01D
	±0.25pF(C)	GRM0225C1C2R5CD05L	GRM0335C1H2R5CD01D	GRM1555C1H2R5CA01D
2.6pF(2R6)	±0.05pF(W)	GRM0225C1C2R6WD05L	GRM0335C1H2R6WD01D	GRM1555C1H2R6WA01D
	±0.1pF(B)	GRM0225C1C2R6BD05L	GRM0335C1H2R6BD01D	GRM1555C1H2R6BA01D
	±0.25pF(C)	GRM0225C1C2R6CD05L	GRM0335C1H2R6CD01D	GRM1555C1H2R6CA01D
2.7pF(2R7)	±0.05pF(W)	GRM0225C1C2R7WD05L	GRM0335C1H2R7WD01D	GRM1555C1H2R7WA01D
	±0.1pF(B)	GRM0225C1C2R7BD05L	GRM0335C1H2R7BD01D	GRM1555C1H2R7BA01D
	±0.25pF(C)	GRM0225C1C2R7CD05L	GRM0335C1H2R7CD01D	GRM1555C1H2R7CA01D
2.8pF(2R8)	±0.05pF(W)	GRM0225C1C2R8WD05L	GRM0335C1H2R8WD01D	GRM1555C1H2R8WA01D
	±0.1pF(B)	GRM0225C1C2R8BD05L	GRM0335C1H2R8BD01D	GRM1555C1H2R8BA01D
	±0.25pF(C)	GRM0225C1C2R8CD05L	GRM0335C1H2R8CD01D	GRM1555C1H2R8CA01D
2.9pF(2R9)	±0.05pF(W)	GRM0225C1C2R9WD05L	GRM0335C1H2R9WD01D	GRM1555C1H2R9WA01D
	±0.1pF(B)	GRM0225C1C2R9BD05L	GRM0335C1H2R9BD01D	GRM1555C1H2R9BA01D
	±0.25pF(C)	GRM0225C1C2R9CD05L	GRM0335C1H2R9CD01D	GRM1555C1H2R9CA01D
3.0pF(3R0)	±0.05pF(W)	GRM0225C1C3R0WD05L	GRM0335C1H3R0WD01D	GRM1555C1H3R0WA01D
	±0.1pF(B)	GRM0225C1C3R0BD05L	GRM0335C1H3R0BD01D	GRM1555C1H3R0BA01D
	±0.25pF(C)	GRM0225C1C3R0CD05L	GRM0335C1H3R0CD01D	GRM1555C1H3R0CA01D
3.1pF(3R1)	±0.05pF(W)	GRM0225C1C3R1WD05L	GRM0335C1H3R1WD01D	GRM1555C1H3R1WA01D
	±0.1pF(B)	GRM0225C1C3R1BD05L	GRM0335C1H3R1BD01D	GRM1555C1H3R1BA01D
	±0.25pF(C)	GRM0225C1C3R1CD05L	GRM0335C1H3R1CD01D	GRM1555C1H3R1CA01D
3.2pF(3R2)	±0.05pF(W)	GRM0225C1C3R2WD05L	GRM0335C1H3R2WD01D	GRM1555C1H3R2WA01D
	±0.1pF(B)	GRM0225C1C3R2BD05L	GRM0335C1H3R2BD01D	GRM1555C1H3R2BA01D
	±0.25pF(C)	GRM0225C1C3R2CD05L	GRM0335C1H3R2CD01D	GRM1555C1H3R2CA01D
3.3pF(3R3)	±0.05pF(W)	GRM0225C1C3R3WD05L	GRM0335C1H3R3WD01D	GRM1555C1H3R3WA01D
	±0.1pF(B)	GRM0225C1C3R3BD05L	GRM0335C1H3R3BD01D	GRM1555C1H3R3BA01D
	±0.25pF(C)	GRM0225C1C3R3CD05L	GRM0335C1H3R3CD01D	GRM1555C1H3R3CA01D
3.4pF(3R4)	±0.05pF(W)	GRM0225C1C3R4WD05L	GRM0335C1H3R4WD01D	GRM1555C1H3R4WA01D
	±0.1pF(B)	GRM0225C1C3R4BD05L	GRM0335C1H3R4BD01D	GRM1555C1H3R4BA01D
	±0.25pF(C)	GRM0225C1C3R4CD05L	GRM0335C1H3R4CD01D	GRM1555C1H3R4CA01D
3.5pF(3R5)	±0.05pF(W)	GRM0225C1C3R5WD05L	GRM0335C1H3R5WD01D	GRM1555C1H3R5WA01D
	±0.1pF(B)	GRM0225C1C3R5BD05L	GRM0335C1H3R5BD01D	GRM1555C1H3R5BA01D
	±0.25pF(C)	GRM0225C1C3R5CD05L	GRM0335C1H3R5CD01D	GRM1555C1H3R5CA01D
3.6pF(3R6)	±0.05pF(W)	GRM0225C1C3R6WD05L	GRM0335C1H3R6WD01D	GRM1555C1H3R6WA01D
	±0.1pF(B)	GRM0225C1C3R6BD05L	GRM0335C1H3R6BD01D	GRM1555C1H3R6BA01D
	±0.25pF(C)	GRM0225C1C3R6CD05L	GRM0335C1H3R6CD01D	GRM1555C1H3R6CA01D
3.7pF(3R7)	±0.05pF(W)	GRM0225C1C3R7WD05L	GRM0335C1H3R7WD01D	GRM1555C1H3R7WA01D
	±0.1pF(B)	GRM0225C1C3R7BD05L	GRM0335C1H3R7BD01D	GRM1555C1H3R7BA01D
	±0.25pF(C)	GRM0225C1C3R7CD05L	GRM0335C1H3R7CD01D	GRM1555C1H3R7CA01D

品名代号在()中注明，单位在 []中注明。< >: EIA [英寸] 代号

温度补偿型 C0G(5C) 特性

长x宽 [mm]		0.4x0.2(02)<01005>	0.6x0.3(03)<0201>	1.0x0.5(15)<0402>
额定电压 [Vdc]		16(1C)	50(1H)	50(1H)
静电容量	公差	品名		
3.8pF(3R8)	±0.05pF(W)	GRM0225C1C3R8WD05L	GRM0335C1H3R8WD01D	GRM1555C1H3R8WA01D
	±0.1pF(B)	GRM0225C1C3R8BD05L	GRM0335C1H3R8BD01D	GRM1555C1H3R8BA01D
	±0.25pF(C)	GRM0225C1C3R8CD05L	GRM0335C1H3R8CD01D	GRM1555C1H3R8CA01D
3.9pF(3R9)	±0.05pF(W)	GRM0225C1C3R9WD05L	GRM0335C1H3R9WD01D	GRM1555C1H3R9WA01D
	±0.1pF(B)	GRM0225C1C3R9BD05L	GRM0335C1H3R9BD01D	GRM1555C1H3R9BA01D
	±0.25pF(C)	GRM0225C1C3R9CD05L	GRM0335C1H3R9CD01D	GRM1555C1H3R9CA01D
4.0pF(4R0)	±0.05pF(W)	GRM0225C1C4R0WD05L	GRM0335C1H4R0WD01D	GRM1555C1H4R0WA01D
	±0.1pF(B)	GRM0225C1C4R0BD05L	GRM0335C1H4R0BD01D	GRM1555C1H4R0BA01D
	±0.25pF(C)	GRM0225C1C4R0CD05L	GRM0335C1H4R0CD01D	GRM1555C1H4R0CA01D
4.1pF(4R1)	±0.05pF(W)	GRM0225C1C4R1WD05L	GRM0335C1H4R1WD01D	GRM1555C1H4R1WA01D
	±0.1pF(B)	GRM0225C1C4R1BD05L	GRM0335C1H4R1BD01D	GRM1555C1H4R1BA01D
	±0.25pF(C)	GRM0225C1C4R1CD05L	GRM0335C1H4R1CD01D	GRM1555C1H4R1CA01D
4.2pF(4R2)	±0.05pF(W)	GRM0225C1C4R2WD05L	GRM0335C1H4R2WD01D	GRM1555C1H4R2WA01D
	±0.1pF(B)	GRM0225C1C4R2BD05L	GRM0335C1H4R2BD01D	GRM1555C1H4R2BA01D
	±0.25pF(C)	GRM0225C1C4R2CD05L	GRM0335C1H4R2CD01D	GRM1555C1H4R2CA01D
4.3pF(4R3)	±0.05pF(W)	GRM0225C1C4R3WD05L	GRM0335C1H4R3WD01D	GRM1555C1H4R3WA01D
	±0.1pF(B)	GRM0225C1C4R3BD05L	GRM0335C1H4R3BD01D	GRM1555C1H4R3BA01D
	±0.25pF(C)	GRM0225C1C4R3CD05L	GRM0335C1H4R3CD01D	GRM1555C1H4R3CA01D
4.4pF(4R4)	±0.05pF(W)	GRM0225C1C4R4WD05L	GRM0335C1H4R4WD01D	GRM1555C1H4R4WA01D
	±0.1pF(B)	GRM0225C1C4R4BD05L	GRM0335C1H4R4BD01D	GRM1555C1H4R4BA01D
	±0.25pF(C)	GRM0225C1C4R4CD05L	GRM0335C1H4R4CD01D	GRM1555C1H4R4CA01D
4.5pF(4R5)	±0.05pF(W)	GRM0225C1C4R5WD05L	GRM0335C1H4R5WD01D	GRM1555C1H4R5WA01D
	±0.1pF(B)	GRM0225C1C4R5BD05L	GRM0335C1H4R5BD01D	GRM1555C1H4R5BA01D
	±0.25pF(C)	GRM0225C1C4R5CD05L	GRM0335C1H4R5CD01D	GRM1555C1H4R5CA01D
4.6pF(4R6)	±0.05pF(W)	GRM0225C1C4R6WD05L	GRM0335C1H4R6WD01D	GRM1555C1H4R6WA01D
	±0.1pF(B)	GRM0225C1C4R6BD05L	GRM0335C1H4R6BD01D	GRM1555C1H4R6BA01D
	±0.25pF(C)	GRM0225C1C4R6CD05L	GRM0335C1H4R6CD01D	GRM1555C1H4R6CA01D
4.7pF(4R7)	±0.05pF(W)	GRM0225C1C4R7WD05L	GRM0335C1H4R7WD01D	GRM1555C1H4R7WA01D
	±0.1pF(B)	GRM0225C1C4R7BD05L	GRM0335C1H4R7BD01D	GRM1555C1H4R7BA01D
	±0.25pF(C)	GRM0225C1C4R7CD05L	GRM0335C1H4R7CD01D	GRM1555C1H4R7CA01D
4.8pF(4R8)	±0.05pF(W)	GRM0225C1C4R8WD05L	GRM0335C1H4R8WD01D	GRM1555C1H4R8WA01D
	±0.1pF(B)	GRM0225C1C4R8BD05L	GRM0335C1H4R8BD01D	GRM1555C1H4R8BA01D
	±0.25pF(C)	GRM0225C1C4R8CD05L	GRM0335C1H4R8CD01D	GRM1555C1H4R8CA01D
4.9pF(4R9)	±0.05pF(W)	GRM0225C1C4R9WD05L	GRM0335C1H4R9WD01D	GRM1555C1H4R9WA01D
	±0.1pF(B)	GRM0225C1C4R9BD05L	GRM0335C1H4R9BD01D	GRM1555C1H4R9BA01D
	±0.25pF(C)	GRM0225C1C4R9CD05L	GRM0335C1H4R9CD01D	GRM1555C1H4R9CA01D
5.0pF(5R0)	±0.05pF(W)	GRM0225C1C5R0WD05L	GRM0335C1H5R0WD01D	GRM1555C1H5R0WA01D
	±0.1pF(B)	GRM0225C1C5R0BD05L	GRM0335C1H5R0BD01D	GRM1555C1H5R0BA01D
	±0.25pF(C)	GRM0225C1C5R0CD05L	GRM0335C1H5R0CD01D	GRM1555C1H5R0CA01D
5.1pF(5R1)	±0.05pF(W)	GRM0225C1C5R1WD05L	GRM0335C1H5R1WD01D	GRM1555C1H5R1WA01D
	±0.1pF(B)	GRM0225C1C5R1BD05L	GRM0335C1H5R1BD01D	GRM1555C1H5R1BA01D
	±0.25pF(C)	GRM0225C1C5R1CD05L	GRM0335C1H5R1CD01D	GRM1555C1H5R1CA01D
5.2pF(5R2)	±0.05pF(W)	GRM0225C1C5R2WD05L	GRM0335C1H5R2WD01D	GRM1555C1H5R2WA01D
	±0.1pF(B)	GRM0225C1C5R2BD05L	GRM0335C1H5R2BD01D	GRM1555C1H5R2BA01D
	±0.25pF(C)	GRM0225C1C5R2CD05L	GRM0335C1H5R2CD01D	GRM1555C1H5R2CA01D
5.3pF(5R3)	±0.05pF(W)	GRM0225C1C5R3WD05L	GRM0335C1H5R3WD01D	GRM1555C1H5R3WA01D
	±0.1pF(B)	GRM0225C1C5R3BD05L	GRM0335C1H5R3BD01D	GRM1555C1H5R3BA01D
	±0.25pF(C)	GRM0225C1C5R3CD05L	GRM0335C1H5R3CD01D	GRM1555C1H5R3CA01D

品名代号在()中注明，单位在 []中注明。< >: EIA [英寸] 代号

- (品名) **GR** **M** **02** **2** **5C** **1C** **3R8** **W** **D05** **L** ① 型号 ② 系列 ③ 尺寸(长×宽) ④ 尺寸(厚度) ⑤ 温度特性
 ⑥ 额定电压 ⑦ 静电容量 ⑧ 静电容量公差 ⑨ 个别规格代号 ⑩ 包装*

品名中的包装代号表示标准180mm卷盘。

*GRM022: 可适用D代码包装方式。

温度补偿型 C0G(5C) 特性

长x宽 [mm]		0.4x0.2(02)<01005>	0.6x0.3(03)<0201>	1.0x0.5(15)<0402>
额定电压 [Vdc]		16(1C)	50(1H)	50(1H)
静电容量	公差	品名		
5.3pF(5R3)	±0.05pF(W)	GRM0225C1C5R3WD05L	GRM0335C1H5R3WD01D	GRM1555C1H5R3WA01D
	±0.1pF(B)	GRM0225C1C5R3BD05L	GRM0335C1H5R3BD01D	GRM1555C1H5R3BA01D
	±0.25pF(C)	GRM0225C1C5R3CD05L	GRM0335C1H5R3CD01D	GRM1555C1H5R3CA01D
	±0.5pF(D)	GRM0225C1C5R3DD05L	GRM0335C1H5R3DD01D	GRM1555C1H5R3DA01D
5.4pF(5R4)	±0.05pF(W)	GRM0225C1C5R4WD05L	GRM0335C1H5R4WD01D	GRM1555C1H5R4WA01D
	±0.1pF(B)	GRM0225C1C5R4BD05L	GRM0335C1H5R4BD01D	GRM1555C1H5R4BA01D
	±0.25pF(C)	GRM0225C1C5R4CD05L	GRM0335C1H5R4CD01D	GRM1555C1H5R4CA01D
	±0.5pF(D)	GRM0225C1C5R4DD05L	GRM0335C1H5R4DD01D	GRM1555C1H5R4DA01D
5.5pF(5R5)	±0.05pF(W)	GRM0225C1C5R5WD05L	GRM0335C1H5R5WD01D	GRM1555C1H5R5WA01D
	±0.1pF(B)	GRM0225C1C5R5BD05L	GRM0335C1H5R5BD01D	GRM1555C1H5R5BA01D
	±0.25pF(C)	GRM0225C1C5R5CD05L	GRM0335C1H5R5CD01D	GRM1555C1H5R5CA01D
	±0.5pF(D)	GRM0225C1C5R5DD05L	GRM0335C1H5R5DD01D	GRM1555C1H5R5DA01D
5.6pF(5R6)	±0.05pF(W)	GRM0225C1C5R6WD05L	GRM0335C1H5R6WD01D	GRM1555C1H5R6WA01D
	±0.1pF(B)	GRM0225C1C5R6BD05L	GRM0335C1H5R6BD01D	GRM1555C1H5R6BA01D
	±0.25pF(C)	GRM0225C1C5R6CD05L	GRM0335C1H5R6CD01D	GRM1555C1H5R6CA01D
	±0.5pF(D)	GRM0225C1C5R6DD05L	GRM0335C1H5R6DD01D	GRM1555C1H5R6DA01D
5.7pF(5R7)	±0.05pF(W)	GRM0225C1C5R7WD05L	GRM0335C1H5R7WD01D	GRM1555C1H5R7WA01D
	±0.1pF(B)	GRM0225C1C5R7BD05L	GRM0335C1H5R7BD01D	GRM1555C1H5R7BA01D
	±0.25pF(C)	GRM0225C1C5R7CD05L	GRM0335C1H5R7CD01D	GRM1555C1H5R7CA01D
	±0.5pF(D)	GRM0225C1C5R7DD05L	GRM0335C1H5R7DD01D	GRM1555C1H5R7DA01D
5.8pF(5R8)	±0.05pF(W)	GRM0225C1C5R8WD05L	GRM0335C1H5R8WD01D	GRM1555C1H5R8WA01D
	±0.1pF(B)	GRM0225C1C5R8BD05L	GRM0335C1H5R8BD01D	GRM1555C1H5R8BA01D
	±0.25pF(C)	GRM0225C1C5R8CD05L	GRM0335C1H5R8CD01D	GRM1555C1H5R8CA01D
	±0.5pF(D)	GRM0225C1C5R8DD05L	GRM0335C1H5R8DD01D	GRM1555C1H5R8DA01D
5.9pF(5R9)	±0.05pF(W)	GRM0225C1C5R9WD05L	GRM0335C1H5R9WD01D	GRM1555C1H5R9WA01D
	±0.1pF(B)	GRM0225C1C5R9BD05L	GRM0335C1H5R9BD01D	GRM1555C1H5R9BA01D
	±0.25pF(C)	GRM0225C1C5R9CD05L	GRM0335C1H5R9CD01D	GRM1555C1H5R9CA01D
	±0.5pF(D)	GRM0225C1C5R9DD05L	GRM0335C1H5R9DD01D	GRM1555C1H5R9DA01D
6.0pF(6R0)	±0.05pF(W)	GRM0225C1C6R0WD05L	GRM0335C1H6R0WD01D	GRM1555C1H6R0WA01D
	±0.1pF(B)	GRM0225C1C6R0BD05L	GRM0335C1H6R0BD01D	GRM1555C1H6R0BA01D
	±0.25pF(C)	GRM0225C1C6R0CD05L	GRM0335C1H6R0CD01D	GRM1555C1H6R0CA01D
	±0.5pF(D)	GRM0225C1C6R0DD05L	GRM0335C1H6R0DD01D	GRM1555C1H6R0DA01D
6.1pF(6R1)	±0.05pF(W)	GRM0225C1C6R1WD05L	GRM0335C1H6R1WD01D	GRM1555C1H6R1WA01D
	±0.1pF(B)	GRM0225C1C6R1BD05L	GRM0335C1H6R1BD01D	GRM1555C1H6R1BA01D
	±0.25pF(C)	GRM0225C1C6R1CD05L	GRM0335C1H6R1CD01D	GRM1555C1H6R1CA01D
	±0.5pF(D)	GRM0225C1C6R1DD05L	GRM0335C1H6R1DD01D	GRM1555C1H6R1DA01D
6.2pF(6R2)	±0.05pF(W)	GRM0225C1C6R2WD05L	GRM0335C1H6R2WD01D	GRM1555C1H6R2WA01D
	±0.1pF(B)	GRM0225C1C6R2BD05L	GRM0335C1H6R2BD01D	GRM1555C1H6R2BA01D
	±0.25pF(C)	GRM0225C1C6R2CD05L	GRM0335C1H6R2CD01D	GRM1555C1H6R2CA01D
	±0.5pF(D)	GRM0225C1C6R2DD05L	GRM0335C1H6R2DD01D	GRM1555C1H6R2DA01D
6.3pF(6R3)	±0.05pF(W)	GRM0225C1C6R3WD05L	GRM0335C1H6R3WD01D	GRM1555C1H6R3WA01D
	±0.1pF(B)	GRM0225C1C6R3BD05L	GRM0335C1H6R3BD01D	GRM1555C1H6R3BA01D
	±0.25pF(C)	GRM0225C1C6R3CD05L	GRM0335C1H6R3CD01D	GRM1555C1H6R3CA01D
	±0.5pF(D)	GRM0225C1C6R3DD05L	GRM0335C1H6R3DD01D	GRM1555C1H6R3DA01D
6.4pF(6R4)	±0.05pF(W)	GRM0225C1C6R4WD05L	GRM0335C1H6R4WD01D	GRM1555C1H6R4WA01D
	±0.1pF(B)	GRM0225C1C6R4BD05L	GRM0335C1H6R4BD01D	GRM1555C1H6R4BA01D
	±0.25pF(C)	GRM0225C1C6R4CD05L	GRM0335C1H6R4CD01D	GRM1555C1H6R4CA01D
	±0.5pF(D)	GRM0225C1C6R4DD05L	GRM0335C1H6R4DD01D	GRM1555C1H6R4DA01D
6.5pF(6R5)	±0.05pF(W)	GRM0225C1C6R5WD05L	GRM0335C1H6R5WD01D	GRM1555C1H6R5WA01D
	±0.1pF(B)	GRM0225C1C6R5BD05L	GRM0335C1H6R5BD01D	GRM1555C1H6R5BA01D
	±0.25pF(C)	GRM0225C1C6R5CD05L	GRM0335C1H6R5CD01D	GRM1555C1H6R5CA01D
	±0.5pF(D)	GRM0225C1C6R5DD05L	GRM0335C1H6R5DD01D	GRM1555C1H6R5DA01D

品名代号在()中注明，单位在 []中注明。<->: EIA [英寸] 代号

温度补偿型 C0G(5C) 特性

长x宽 [mm]		0.4x0.2(02)<01005>	0.6x0.3(03)<0201>	1.0x0.5(15)<0402>
额定电压 [Vdc]		16(1C)	50(1H)	50(1H)
静电容量	公差	品名		
6.6pF(6R6)	±0.05pF(W)	GRM0225C1C6R6WD05L	GRM0335C1H6R6WD01D	GRM1555C1H6R6WA01D
	±0.1pF(B)	GRM0225C1C6R6BD05L	GRM0335C1H6R6BD01D	GRM1555C1H6R6BA01D
	±0.25pF(C)	GRM0225C1C6R6CD05L	GRM0335C1H6R6CD01D	GRM1555C1H6R6CA01D
	±0.5pF(D)	GRM0225C1C6R6DD05L	GRM0335C1H6R6DD01D	GRM1555C1H6R6DA01D
6.7pF(6R7)	±0.05pF(W)	GRM0225C1C6R7WD05L	GRM0335C1H6R7WD01D	GRM1555C1H6R7WA01D
	±0.1pF(B)	GRM0225C1C6R7BD05L	GRM0335C1H6R7BD01D	GRM1555C1H6R7BA01D
	±0.25pF(C)	GRM0225C1C6R7CD05L	GRM0335C1H6R7CD01D	GRM1555C1H6R7CA01D
	±0.5pF(D)	GRM0225C1C6R7DD05L	GRM0335C1H6R7DD01D	GRM1555C1H6R7DA01D
6.8pF(6R8)	±0.05pF(W)	GRM0225C1C6R8WD05L	GRM0335C1H6R8WD01D	GRM1555C1H6R8WA01D
	±0.1pF(B)	GRM0225C1C6R8BD05L	GRM0335C1H6R8BD01D	GRM1555C1H6R8BA01D
	±0.25pF(C)	GRM0225C1C6R8CD05L	GRM0335C1H6R8CD01D	GRM1555C1H6R8CA01D
	±0.5pF(D)	GRM0225C1C6R8DD05L	GRM0335C1H6R8DD01D	GRM1555C1H6R8DA01D
6.9pF(6R9)	±0.05pF(W)	GRM0225C1C6R9WD05L	GRM0335C1H6R9WD01D	GRM1555C1H6R9WA01D
	±0.1pF(B)	GRM0225C1C6R9BD05L	GRM0335C1H6R9BD01D	GRM1555C1H6R9BA01D
	±0.25pF(C)	GRM0225C1C6R9CD05L	GRM0335C1H6R9CD01D	GRM1555C1H6R9CA01D
	±0.5pF(D)	GRM0225C1C6R9DD05L	GRM0335C1H6R9DD01D	GRM1555C1H6R9DA01D
7.0pF(7R0)	±0.05pF(W)	GRM0225C1C7R0WD05L	GRM0335C1H7R0WD01D	GRM1555C1H7R0WA01D
	±0.1pF(B)	GRM0225C1C7R0BD05L	GRM0335C1H7R0BD01D	GRM1555C1H7R0BA01D
	±0.25pF(C)	GRM0225C1C7R0CD05L	GRM0335C1H7R0CD01D	GRM1555C1H7R0CA01D
	±0.5pF(D)	GRM0225C1C7R0DD05L	GRM0335C1H7R0DD01D	GRM1555C1H7R0DA01D
7.1pF(7R1)	±0.05pF(W)	GRM0225C1C7R1WD05L	GRM0335C1H7R1WD01D	GRM1555C1H7R1WA01D
	±0.1pF(B)	GRM0225C1C7R1BD05L	GRM0335C1H7R1BD01D	GRM1555C1H7R1BA01D
	±0.25pF(C)	GRM0225C1C7R1CD05L	GRM0335C1H7R1CD01D	GRM1555C1H7R1CA01D
	±0.5pF(D)	GRM0225C1C7R1DD05L	GRM0335C1H7R1DD01D	GRM1555C1H7R1DA01D
7.2pF(7R2)	±0.05pF(W)	GRM0225C1C7R2WD05L	GRM0335C1H7R2WD01D	GRM1555C1H7R2WA01D
	±0.1pF(B)	GRM0225C1C7R2BD05L	GRM0335C1H7R2BD01D	GRM1555C1H7R2BA01D
	±0.25pF(C)	GRM0225C1C7R2CD05L	GRM0335C1H7R2CD01D	GRM1555C1H7R2CA01D
	±0.5pF(D)	GRM0225C1C7R2DD05L	GRM0335C1H7R2DD01D	GRM1555C1H7R2DA01D
7.3pF(7R3)	±0.05pF(W)	GRM0225C1C7R3WD05L	GRM0335C1H7R3WD01D	GRM1555C1H7R3WA01D
	±0.1pF(B)	GRM0225C1C7R3BD05L	GRM0335C1H7R3BD01D	GRM1555C1H7R3BA01D
	±0.25pF(C)	GRM0225C1C7R3CD05L	GRM0335C1H7R3CD01D	GRM1555C1H7R3CA01D
	±0.5pF(D)	GRM0225C1C7R3DD05L	GRM0335C1H7R3DD01D	GRM1555C1H7R3DA01D
7.4pF(7R4)	±0.05pF(W)	GRM0225C1C7R4WD05L	GRM0335C1H7R4WD01D	GRM1555C1H7R4WA01D
	±0.1pF(B)	GRM0225C1C7R4BD05L	GRM0335C1H7R4BD01D	GRM1555C1H7R4BA01D
	±0.25pF(C)	GRM0225C1C7R4CD05L	GRM0335C1H7R4CD01D	GRM1555C1H7R4CA01D
	±0.5pF(D)	GRM0225C1C7R4DD05L	GRM0335C1H7R4DD01D	GRM1555C1H7R4DA01D
7.5pF(7R5)	±0.05pF(W)	GRM0225C1C7R5WD05L	GRM0335C1H7R5WD01D	GRM1555C1H7R5WA01D
	±0.1pF(B)	GRM0225C1C7R5BD05L	GRM0335C1H7R5BD01D	GRM1555C1H7R5BA01D
	±0.25pF(C)	GRM0225C1C7R5CD05L	GRM0335C1H7R5CD01D	GRM1555C1H7R5CA01D
	±0.5pF(D)	GRM0225C1C7R5DD05L	GRM0335C1H7R5DD01D	GRM1555C1H7R5DA01D
7.6pF(7R6)	±0.05pF(W)	GRM0225C1C7R6WD05L	GRM0335C1H7R6WD01D	GRM1555C1H7R6WA01D
	±0.1pF(B)	GRM0225C1C7R6BD05L	GRM0335C1H7R6BD01D	GRM1555C1H7R6BA01D
	±0.25pF(C)	GRM0225C1C7R6CD05L	GRM0335C1H7R6CD01D	GRM1555C1H7R6CA01D
	±0.5pF(D)	GRM0225C1C7R6DD05L	GRM0335C1H7R6DD01D	GRM1555C1H7R6DA01D
7.7pF(7R7)	±0.05pF(W)	GRM0225C1C7R7WD05L	GRM0335C1H7R7WD01D	GRM1555C1H7R7WA01D
	±0.1pF(B)	GRM0225C1C7R7BD05L	GRM0335C1H7R7BD01D	GRM1555C1H7R7BA01D
	±0.25pF(C)	GRM0225C1C7R7CD05L	GRM0335C1H7R7CD01D	GRM1555C1H7R7CA01D
	±0.5pF(D)	GRM0225C1C7R7DD05L	GRM0335C1H7R7DD01D	GRM1555C1H7R7DA01D

品名代号在()中注明，单位在 []中注明。< >: EIA [英寸] 代号

- (品名) **GR** **M** **02** **2** **5C** **1C** **6R6** **W** **D05** **L** ①型号 ②系列 ③尺寸(长×宽) ④尺寸(厚度) ⑤温度特性
 ① ② ③ ④ ⑤ ⑥ ⑦ ⑧ ⑨ ⑩ ⑥额定电压 ⑦静电容量 ⑧静电容量公差 ⑨个别规格代号 ⑩包装*

品名中的包装代号表示标准180mm卷盘。

*GRM022: 可适用D代码包装方式。

温度补偿型 C0G(5C) 特性

长x宽 [mm]		0.4x0.2(02)<01005>	0.6x0.3(03)<0201>	1.0x0.5(15)<0402>
额定电压 [Vdc]		16(1C)	50(1H)	50(1H)
静电容量	公差	品名		
7.8pF(7R8)	±0.05pF(W)	GRM0225C1C7R8WD05L	GRM0335C1H7R8WD01D	GRM1555C1H7R8WA01D
	±0.1pF(B)	GRM0225C1C7R8BD05L	GRM0335C1H7R8BD01D	GRM1555C1H7R8BA01D
	±0.25pF(C)	GRM0225C1C7R8CD05L	GRM0335C1H7R8CD01D	GRM1555C1H7R8CA01D
	±0.5pF(D)	GRM0225C1C7R8DD05L	GRM0335C1H7R8DD01D	GRM1555C1H7R8DA01D
7.9pF(7R9)	±0.05pF(W)	GRM0225C1C7R9WD05L	GRM0335C1H7R9WD01D	GRM1555C1H7R9WA01D
	±0.1pF(B)	GRM0225C1C7R9BD05L	GRM0335C1H7R9BD01D	GRM1555C1H7R9BA01D
	±0.25pF(C)	GRM0225C1C7R9CD05L	GRM0335C1H7R9CD01D	GRM1555C1H7R9CA01D
	±0.5pF(D)	GRM0225C1C7R9DD05L	GRM0335C1H7R9DD01D	GRM1555C1H7R9DA01D
8.0pF(8R0)	±0.05pF(W)	GRM0225C1C8R0WD05L	GRM0335C1H8R0WD01D	GRM1555C1H8R0WA01D
	±0.1pF(B)	GRM0225C1C8R0BD05L	GRM0335C1H8R0BD01D	GRM1555C1H8R0BA01D
	±0.25pF(C)	GRM0225C1C8R0CD05L	GRM0335C1H8R0CD01D	GRM1555C1H8R0CA01D
	±0.5pF(D)	GRM0225C1C8R0DD05L	GRM0335C1H8R0DD01D	GRM1555C1H8R0DA01D
8.1pF(8R1)	±0.05pF(W)	GRM0225C1C8R1WD05L	GRM0335C1H8R1WD01D	GRM1555C1H8R1WA01D
	±0.1pF(B)	GRM0225C1C8R1BD05L	GRM0335C1H8R1BD01D	GRM1555C1H8R1BA01D
	±0.25pF(C)	GRM0225C1C8R1CD05L	GRM0335C1H8R1CD01D	GRM1555C1H8R1CA01D
	±0.5pF(D)	GRM0225C1C8R1DD05L	GRM0335C1H8R1DD01D	GRM1555C1H8R1DA01D
8.2pF(8R2)	±0.05pF(W)	GRM0225C1C8R2WD05L	GRM0335C1H8R2WD01D	GRM1555C1H8R2WA01D
	±0.1pF(B)	GRM0225C1C8R2BD05L	GRM0335C1H8R2BD01D	GRM1555C1H8R2BA01D
	±0.25pF(C)	GRM0225C1C8R2CD05L	GRM0335C1H8R2CD01D	GRM1555C1H8R2CA01D
	±0.5pF(D)	GRM0225C1C8R2DD05L	GRM0335C1H8R2DD01D	GRM1555C1H8R2DA01D
8.3pF(8R3)	±0.05pF(W)	GRM0225C1C8R3WD05L	GRM0335C1H8R3WD01D	GRM1555C1H8R3WA01D
	±0.1pF(B)	GRM0225C1C8R3BD05L	GRM0335C1H8R3BD01D	GRM1555C1H8R3BA01D
	±0.25pF(C)	GRM0225C1C8R3CD05L	GRM0335C1H8R3CD01D	GRM1555C1H8R3CA01D
	±0.5pF(D)	GRM0225C1C8R3DD05L	GRM0335C1H8R3DD01D	GRM1555C1H8R3DA01D
8.4pF(8R4)	±0.05pF(W)	GRM0225C1C8R4WD05L	GRM0335C1H8R4WD01D	GRM1555C1H8R4WA01D
	±0.1pF(B)	GRM0225C1C8R4BD05L	GRM0335C1H8R4BD01D	GRM1555C1H8R4BA01D
	±0.25pF(C)	GRM0225C1C8R4CD05L	GRM0335C1H8R4CD01D	GRM1555C1H8R4CA01D
	±0.5pF(D)	GRM0225C1C8R4DD05L	GRM0335C1H8R4DD01D	GRM1555C1H8R4DA01D
8.5pF(8R5)	±0.05pF(W)	GRM0225C1C8R5WD05L	GRM0335C1H8R5WD01D	GRM1555C1H8R5WA01D
	±0.1pF(B)	GRM0225C1C8R5BD05L	GRM0335C1H8R5BD01D	GRM1555C1H8R5BA01D
	±0.25pF(C)	GRM0225C1C8R5CD05L	GRM0335C1H8R5CD01D	GRM1555C1H8R5CA01D
	±0.5pF(D)	GRM0225C1C8R5DD05L	GRM0335C1H8R5DD01D	GRM1555C1H8R5DA01D
8.6pF(8R6)	±0.05pF(W)	GRM0225C1C8R6WD05L	GRM0335C1H8R6WD01D	GRM1555C1H8R6WA01D
	±0.1pF(B)	GRM0225C1C8R6BD05L	GRM0335C1H8R6BD01D	GRM1555C1H8R6BA01D
	±0.25pF(C)	GRM0225C1C8R6CD05L	GRM0335C1H8R6CD01D	GRM1555C1H8R6CA01D
	±0.5pF(D)	GRM0225C1C8R6DD05L	GRM0335C1H8R6DD01D	GRM1555C1H8R6DA01D
8.7pF(8R7)	±0.05pF(W)	GRM0225C1C8R7WD05L	GRM0335C1H8R7WD01D	GRM1555C1H8R7WA01D
	±0.1pF(B)	GRM0225C1C8R7BD05L	GRM0335C1H8R7BD01D	GRM1555C1H8R7BA01D
	±0.25pF(C)	GRM0225C1C8R7CD05L	GRM0335C1H8R7CD01D	GRM1555C1H8R7CA01D
	±0.5pF(D)	GRM0225C1C8R7DD05L	GRM0335C1H8R7DD01D	GRM1555C1H8R7DA01D
8.8pF(8R8)	±0.05pF(W)	GRM0225C1C8R8WD05L	GRM0335C1H8R8WD01D	GRM1555C1H8R8WA01D
	±0.1pF(B)	GRM0225C1C8R8BD05L	GRM0335C1H8R8BD01D	GRM1555C1H8R8BA01D
	±0.25pF(C)	GRM0225C1C8R8CD05L	GRM0335C1H8R8CD01D	GRM1555C1H8R8CA01D
	±0.5pF(D)	GRM0225C1C8R8DD05L	GRM0335C1H8R8DD01D	GRM1555C1H8R8DA01D
8.9pF(8R9)	±0.05pF(W)	GRM0225C1C8R9WD05L	GRM0335C1H8R9WD01D	GRM1555C1H8R9WA01D
	±0.1pF(B)	GRM0225C1C8R9BD05L	GRM0335C1H8R9BD01D	GRM1555C1H8R9BA01D
	±0.25pF(C)	GRM0225C1C8R9CD05L	GRM0335C1H8R9CD01D	GRM1555C1H8R9CA01D
	±0.5pF(D)	GRM0225C1C8R9DD05L	GRM0335C1H8R9DD01D	GRM1555C1H8R9DA01D
9.0pF(9R0)	±0.05pF(W)	GRM0225C1C9R0WD05L	GRM0335C1H9R0WD01D	GRM1555C1H9R0WA01D
	±0.1pF(B)	GRM0225C1C9R0BD05L	GRM0335C1H9R0BD01D	GRM1555C1H9R0BA01D
	±0.25pF(C)	GRM0225C1C9R0CD05L	GRM0335C1H9R0CD01D	GRM1555C1H9R0CA01D
	±0.5pF(D)	GRM0225C1C9R0DD05L	GRM0335C1H9R0DD01D	GRM1555C1H9R0DA01D

品名代号在()中注明，单位在 []中注明。<>: EIA [英寸] 代号

温度补偿型 C0G(5C) 特性

长x宽 [mm]		0.4x0.2(02)<01005>	0.6x0.3(03)<0201>	1.0x0.5(15)<0402>
额定电压 [Vdc]		16(1C)	50(1H)	50(1H)
静电容量	公差	品名		
9.1pF(9R1)	±0.05pF(W)	GRM0225C1C9R1WD05L	GRM0335C1H9R1WD01D	GRM1555C1H9R1WA01D
	±0.1pF(B)	GRM0225C1C9R1BD05L	GRM0335C1H9R1BD01D	GRM1555C1H9R1BA01D
	±0.25pF(C)	GRM0225C1C9R1CD05L	GRM0335C1H9R1CD01D	GRM1555C1H9R1CA01D
	±0.5pF(D)	GRM0225C1C9R1DD05L	GRM0335C1H9R1DD01D	GRM1555C1H9R1DA01D
9.2pF(9R2)	±0.05pF(W)	GRM0225C1C9R2WD05L	GRM0335C1H9R2WD01D	GRM1555C1H9R2WA01D
	±0.1pF(B)	GRM0225C1C9R2BD05L	GRM0335C1H9R2BD01D	GRM1555C1H9R2BA01D
	±0.25pF(C)	GRM0225C1C9R2CD05L	GRM0335C1H9R2CD01D	GRM1555C1H9R2CA01D
	±0.5pF(D)	GRM0225C1C9R2DD05L	GRM0335C1H9R2DD01D	GRM1555C1H9R2DA01D
9.3pF(9R3)	±0.05pF(W)	GRM0225C1C9R3WD05L	GRM0335C1H9R3WD01D	GRM1555C1H9R3WA01D
	±0.1pF(B)	GRM0225C1C9R3BD05L	GRM0335C1H9R3BD01D	GRM1555C1H9R3BA01D
	±0.25pF(C)	GRM0225C1C9R3CD05L	GRM0335C1H9R3CD01D	GRM1555C1H9R3CA01D
	±0.5pF(D)	GRM0225C1C9R3DD05L	GRM0335C1H9R3DD01D	GRM1555C1H9R3DA01D
9.4pF(9R4)	±0.05pF(W)	GRM0225C1C9R4WD05L	GRM0335C1H9R4WD01D	GRM1555C1H9R4WA01D
	±0.1pF(B)	GRM0225C1C9R4BD05L	GRM0335C1H9R4BD01D	GRM1555C1H9R4BA01D
	±0.25pF(C)	GRM0225C1C9R4CD05L	GRM0335C1H9R4CD01D	GRM1555C1H9R4CA01D
	±0.5pF(D)	GRM0225C1C9R4DD05L	GRM0335C1H9R4DD01D	GRM1555C1H9R4DA01D
9.5pF(9R5)	±0.05pF(W)	GRM0225C1C9R5WD05L	GRM0335C1H9R5WD01D	GRM1555C1H9R5WA01D
	±0.1pF(B)	GRM0225C1C9R5BD05L	GRM0335C1H9R5BD01D	GRM1555C1H9R5BA01D
	±0.25pF(C)	GRM0225C1C9R5CD05L	GRM0335C1H9R5CD01D	GRM1555C1H9R5CA01D
	±0.5pF(D)	GRM0225C1C9R5DD05L	GRM0335C1H9R5DD01D	GRM1555C1H9R5DA01D
9.6pF(9R6)	±0.05pF(W)	GRM0225C1C9R6WD05L	GRM0335C1H9R6WD01D	GRM1555C1H9R6WA01D
	±0.1pF(B)	GRM0225C1C9R6BD05L	GRM0335C1H9R6BD01D	GRM1555C1H9R6BA01D
	±0.25pF(C)	GRM0225C1C9R6CD05L	GRM0335C1H9R6CD01D	GRM1555C1H9R6CA01D
	±0.5pF(D)	GRM0225C1C9R6DD05L	GRM0335C1H9R6DD01D	GRM1555C1H9R6DA01D
9.7pF(9R7)	±0.05pF(W)	GRM0225C1C9R7WD05L	GRM0335C1H9R7WD01D	GRM1555C1H9R7WA01D
	±0.1pF(B)	GRM0225C1C9R7BD05L	GRM0335C1H9R7BD01D	GRM1555C1H9R7BA01D
	±0.25pF(C)	GRM0225C1C9R7CD05L	GRM0335C1H9R7CD01D	GRM1555C1H9R7CA01D
	±0.5pF(D)	GRM0225C1C9R7DD05L	GRM0335C1H9R7DD01D	GRM1555C1H9R7DA01D
9.8pF(9R8)	±0.05pF(W)	GRM0225C1C9R8WD05L	GRM0335C1H9R8WD01D	GRM1555C1H9R8WA01D
	±0.1pF(B)	GRM0225C1C9R8BD05L	GRM0335C1H9R8BD01D	GRM1555C1H9R8BA01D
	±0.25pF(C)	GRM0225C1C9R8CD05L	GRM0335C1H9R8CD01D	GRM1555C1H9R8CA01D
	±0.5pF(D)	GRM0225C1C9R8DD05L	GRM0335C1H9R8DD01D	GRM1555C1H9R8DA01D
9.9pF(9R9)	±0.05pF(W)	GRM0225C1C9R9WD05L	GRM0335C1H9R9WD01D	GRM1555C1H9R9WA01D
	±0.1pF(B)	GRM0225C1C9R9BD05L	GRM0335C1H9R9BD01D	GRM1555C1H9R9BA01D
	±0.25pF(C)	GRM0225C1C9R9CD05L	GRM0335C1H9R9CD01D	GRM1555C1H9R9CA01D
	±0.5pF(D)	GRM0225C1C9R9DD05L	GRM0335C1H9R9DD01D	GRM1555C1H9R9DA01D

品名代号在()中注明，单位在[]中注明。< >: EIA [英寸] 代号

(品名) GR M 02 2 5C 1C 9R1 W D05 L
 ① ② ③ ④ ⑤ ⑥ ⑦ ⑧ ⑨ ⑩

- ① 型号
- ② 系列
- ③ 尺寸 (长 × 宽)
- ④ 尺寸 (厚度)
- ⑤ 温度特性
- ⑥ 额定电压
- ⑦ 静电容量
- ⑧ 静电容量公差
- ⑨ 个别规格代号
- ⑩ 包装*

品名中的包装代号表示标准180mm卷盘。

*GRM022: 可适用D代码包装方式。

温度补偿型 C0G(5C) 特性

长x宽 [mm]		0.4x0.2(02)<01005>			0.6x0.3(03)<0201>
额定电压 [Vdc]		16(1C)	10(1A)	6.3(0J)	50(1H)
静电容量	公差	品名			
10pF(100)	±2%(G)	GRM0225C1C100GD05L			GRM0335C1H100GD01D
	±5%(J)	GRM0225C1C100JD05L			GRM0335C1H100JD01D
12pF(120)	±2%(G)	GRM0225C1C120GD05L			GRM0335C1H120GD01D
	±5%(J)	GRM0225C1C120JD05L			GRM0335C1H120JD01D
15pF(150)	±2%(G)	GRM0225C1C150GD05L			GRM0335C1H150GD01D
	±5%(J)	GRM0225C1C150JD05L			GRM0335C1H150JD01D
18pF(180)	±2%(G)	GRM0225C1C180GD05L			GRM0335C1H180GD01D
	±5%(J)	GRM0225C1C180JD05L			GRM0335C1H180JD01D
22pF(220)	±2%(G)	GRM0225C1C220GD05L			GRM0335C1H220GD01D
	±5%(J)	GRM0225C1C220JD05L			GRM0335C1H220JD01D
27pF(270)	±2%(G)	GRM0225C1C270GD05L			GRM0335C1H270GD01D
	±5%(J)	GRM0225C1C270JD05L			GRM0335C1H270JD01D
33pF(330)	±2%(G)	GRM0225C1C330GD05L			GRM0335C1H330GD01D
	±5%(J)	GRM0225C1C330JD05L			GRM0335C1H330JD01D
39pF(390)	±2%(G)	GRM0225C1C390GD05L			GRM0335C1H390GD01D
	±5%(J)	GRM0225C1C390JD05L			GRM0335C1H390JD01D
47pF(470)	±2%(G)	GRM0225C1C470GD05L			GRM0335C1H470GD01D
	±5%(J)	GRM0225C1C470JD05L			GRM0335C1H470JD01D
56pF(560)	±2%(G)		GRM0225C1A560GD05L	GRM0225C0J560GD05L	GRM0335C1H560GD01D
	±5%(J)		GRM0225C1A560JD05L	GRM0225C0J560JD05L	GRM0335C1H560JD01D
68pF(680)	±2%(G)		GRM0225C1A680GD05L	GRM0225C0J680GD05L	GRM0335C1H680GD01D
	±5%(J)		GRM0225C1A680JD05L	GRM0225C0J680JD05L	GRM0335C1H680JD01D
82pF(820)	±2%(G)		GRM0225C1A820GD05L	GRM0225C0J820GD05L	GRM0335C1H820GD01D
	±5%(J)		GRM0225C1A820JD05L	GRM0225C0J820JD05L	GRM0335C1H820JD01D
100pF(101)	±2%(G)		GRM0225C1A101GD05L	GRM0225C0J101GD05L	GRM0335C1H101GD01D
	±5%(J)		GRM0225C1A101JD05L	GRM0225C0J101JD05L	GRM0335C1H101JD01D

品名代号在()中注明，单位在 []中注明。< >: EIA [英寸] 代号

温度补偿型 C0G(5C) 特性

长x宽 [mm]		1.0x0.5(15)<0402>
额定电压 [Vdc]		50(1H)
TC代号		C0G(5C)
静电容量	公差	品名
10pF(100)	±2%(G)	GRM1555C1H100GA01D
	±5%(J)	GRM1555C1H100JA01D
12pF(120)	±2%(G)	GRM1555C1H120GA01D
	±5%(J)	GRM1555C1H120JA01D
15pF(150)	±2%(G)	GRM1555C1H150GA01D
	±5%(J)	GRM1555C1H150JA01D
18pF(180)	±2%(G)	GRM1555C1H180GA01D
	±5%(J)	GRM1555C1H180JA01D
22pF(220)	±2%(G)	GRM1555C1H220GA01D
	±5%(J)	GRM1555C1H220JA01D
27pF(270)	±2%(G)	GRM1555C1H270GA01D
	±5%(J)	GRM1555C1H270JA01D
33pF(330)	±2%(G)	GRM1555C1H330GA01D
	±5%(J)	GRM1555C1H330JA01D
39pF(390)	±2%(G)	GRM1555C1H390GA01D
	±5%(J)	GRM1555C1H390JA01D
47pF(470)	±2%(G)	GRM1555C1H470GA01D
	±5%(J)	GRM1555C1H470JA01D
56pF(560)	±2%(G)	GRM1555C1H560GA01D
	±5%(J)	GRM1555C1H560JA01D
68pF(680)	±2%(G)	GRM1555C1H680GA01D
	±5%(J)	GRM1555C1H680JA01D
82pF(820)	±2%(G)	GRM1555C1H820GA01D
	±5%(J)	GRM1555C1H820JA01D
100pF(101)	±2%(G)	GRM1555C1H101GA01D
	±5%(J)	GRM1555C1H101JA01D
120pF(121)	±2%(G)	GRM1555C1H121GA01D
	±5%(J)	GRM1555C1H121JA01D
150pF(151)	±2%(G)	GRM1555C1H151GA01D
	±5%(J)	GRM1555C1H151JA01D
180pF(181)	±2%(G)	GRM1555C1H181GA01D
	±5%(J)	GRM1555C1H181JA01D
220pF(221)	±2%(G)	GRM1555C1H221GA01D
	±5%(J)	GRM1555C1H221JA01D
270pF(271)	±2%(G)	GRM1555C1H271GA01D
	±5%(J)	GRM1555C1H271JA01D
330pF(331)	±2%(G)	GRM1555C1H331GA01D
	±5%(J)	GRM1555C1H331JA01D
390pF(391)	±2%(G)	GRM1555C1H391GA01D
	±5%(J)	GRM1555C1H391JA01D
470pF(471)	±2%(G)	GRM1555C1H471GA01D
	±5%(J)	GRM1555C1H471JA01D
560pF(561)	±2%(G)	GRM1555C1H561GA01D
	±5%(J)	GRM1555C1H561JA01D
680pF(681)	±2%(G)	GRM1555C1H681GA01D
	±5%(J)	GRM1555C1H681JA01D
820pF(821)	±2%(G)	GRM1555C1H821GA01D
	±5%(J)	GRM1555C1H821JA01D
1000pF(102)	±2%(G)	GRM1555C1H102GA01D
	±5%(J)	GRM1555C1H102JA01D

品名代号在()中注明，单位在 []中注明。< >: EIA [英寸] 代号

- (品名) GR M 15 5 5C 1H 100 G Z01 D ①型号 ②系列 ③尺寸(长×宽) ④尺寸(厚度) ⑤温度特性
 ⑥额定电压 ⑦静电容量 ⑧静电容量公差 ⑨个别规格代号 ⑩包装

品名中的包装代号表示标准180mm卷盘。

温度补偿型 C0G(5C) 特性

长x宽 [mm]		1.6x0.8(18)<0603>	
额定电压 [Vdc]		100(2A)	50(1H)
静电容量	公差	品名	
10pF(100)	±5%(J)	GRM1885C2A100JA01D	GRM1885C1H100JA01D
12pF(120)	±5%(J)	GRM1885C2A120JA01D	GRM1885C1H120JA01D
15pF(150)	±5%(J)	GRM1885C2A150JA01D	GRM1885C1H150JA01D
18pF(180)	±5%(J)	GRM1885C2A180JA01D	GRM1885C1H180JA01D
22pF(220)	±5%(J)	GRM1885C2A220JA01D	GRM1885C1H220JA01D
27pF(270)	±5%(J)	GRM1885C2A270JA01D	GRM1885C1H270JA01D
33pF(330)	±5%(J)	GRM1885C2A330JA01D	GRM1885C1H330JA01D
39pF(390)	±5%(J)	GRM1885C2A390JA01D	GRM1885C1H390JA01D
47pF(470)	±5%(J)	GRM1885C2A470JA01D	GRM1885C1H470JA01D
56pF(560)	±5%(J)	GRM1885C2A560JA01D	GRM1885C1H560JA01D
68pF(680)	±5%(J)	GRM1885C2A680JA01D	GRM1885C1H680JA01D
82pF(820)	±5%(J)	GRM1885C2A820JA01D	GRM1885C1H820JA01D
100pF(101)	±5%(J)	GRM1885C2A101JA01D	GRM1885C1H101JA01D
120pF(121)	±5%(J)	GRM1885C2A121JA01D	GRM1885C1H121JA01D
150pF(151)	±5%(J)	GRM1885C2A151JA01D	GRM1885C1H151JA01D
180pF(181)	±5%(J)	GRM1885C2A181JA01D	GRM1885C1H181JA01D
220pF(221)	±5%(J)	GRM1885C2A221JA01D	GRM1885C1H221JA01D
270pF(271)	±5%(J)	GRM1885C2A271JA01D	GRM1885C1H271JA01D
330pF(331)	±5%(J)	GRM1885C2A331JA01D	GRM1885C1H331JA01D
390pF(391)	±5%(J)	GRM1885C2A391JA01D	GRM1885C1H391JA01D
470pF(471)	±5%(J)	GRM1885C2A471JA01D	GRM1885C1H471JA01D
560pF(561)	±5%(J)	GRM1885C2A561JA01D	GRM1885C1H561JA01D
680pF(681)	±5%(J)	GRM1885C2A681JA01D	GRM1885C1H681JA01D
820pF(821)	±5%(J)	GRM1885C2A821JA01D	GRM1885C1H821JA01D
1000pF(102)	±5%(J)	GRM1885C2A102JA01D	GRM1885C1H102JA01D
1200pF(122)	±5%(J)	GRM1885C2A122JA01D	GRM1885C1H122JA01D
1500pF(152)	±5%(J)	GRM1885C2A152JA01D	GRM1885C1H152JA01D
1800pF(182)	±5%(J)		GRM1885C1H182JA01D
2200pF(222)	±5%(J)		GRM1885C1H222JA01D
2700pF(272)	±5%(J)		GRM1885C1H272JA01D
3300pF(332)	±5%(J)		GRM1885C1H332JA01D
3900pF(392)	±5%(J)		GRM1885C1H392JA01D

品名代号在()中注明，单位在 []中注明。< >: EIA [英寸] 代号

温度补偿型 C0G(5C) 特性

长x宽 [mm]		2.0x1.25(21)<0805>		3.2x1.6(31)<1206>	
额定电压 [Vdc]		100(2A)	50(1H)	100(2A)	50(1H)
静电容量	公差	品名			
100pF(101)	±5%(J)	GRM2165C2A101JA01D			
120pF(121)	±5%(J)	GRM2165C2A121JA01D			
150pF(151)	±5%(J)	GRM2165C2A151JA01D			
180pF(181)	±5%(J)	GRM2165C2A181JA01D			
220pF(221)	±5%(J)	GRM2165C2A221JA01D			
270pF(271)	±5%(J)	GRM2165C2A271JA01D			
330pF(331)	±5%(J)	GRM2165C2A331JA01D			
390pF(391)	±5%(J)	GRM2165C2A391JA01D			
470pF(471)	±5%(J)	GRM2165C2A471JA01D			
560pF(561)	±5%(J)	GRM2165C2A561JA01D			
680pF(681)	±5%(J)	GRM2165C2A681JA01D			
820pF(821)	±5%(J)	GRM2165C2A821JA01D			
1000pF(102)	±5%(J)	GRM2165C2A102JA01D			
1200pF(122)	±5%(J)	GRM2165C2A122JA01D	GRM2165C1H122JA01D		
1500pF(152)	±5%(J)	GRM2165C2A152JA01D	GRM2165C1H152JA01D		
1800pF(182)	±5%(J)	GRM2165C2A182JA01D	GRM2165C1H182JA01D	GRM3195C2A182JA01D	
2200pF(222)	±5%(J)	GRM2165C2A222JA01D	GRM2165C1H222JA01D	GRM3195C2A222JA01D	
2700pF(272)	±5%(J)	GRM2165C2A272JA01D	GRM2165C1H272JA01D	GRM3195C2A272JA01D	
3300pF(332)	±5%(J)	GRM2165C2A332JA01D	GRM2165C1H332JA01D	GRM3195C2A332JA01D	
3900pF(392)	±5%(J)		GRM2165C1H392JA01D	GRM3195C2A392JA01D	
4700pF(472)	±5%(J)		GRM2165C1H472JA01D	GRM3195C2A472JA01D	GRM3195C1H472JA01D
5600pF(562)	±5%(J)		GRM2195C1H562JA01D	GRM3195C2A562JA01D	GRM3195C1H562JA01D
6800pF(682)	±5%(J)		GRM2195C1H682JA01D	GRM3195C2A682JA01D	GRM3195C1H682JA01D
8200pF(822)	±5%(J)		GRM2195C1H822JA01D	GRM3195C2A822JA01D	GRM3195C1H822JA01D
10000pF(103)	±5%(J)		GRM2195C1H103JA01D	GRM3195C2A103JA01D	GRM3195C1H103JA01D
12000pF(123)	±5%(J)		GRM2195C1H123JA01D		GRM3195C1H123JA01D
15000pF(153)	±5%(J)		GRM2195C1H153JA01D		GRM3195C1H153JA01D
18000pF(183)	±5%(J)		GRM21B5C1H183JA01L		GRM3195C1H183JA01D
22000pF(223)	±5%(J)		GRM21B5C1H223JA01L		GRM3195C1H223JA01D
27000pF(273)	±5%(J)				GRM3195C1H273JA01D
33000pF(333)	±5%(J)				GRM3195C1H333JA01D
39000pF(393)	±5%(J)				GRM3195C1H393JA01D
47000pF(473)	±5%(J)				GRM31M5C1H473JA01L
56000pF(563)	±5%(J)				GRM31M5C1H563JA01L
68000pF(683)	±5%(J)				GRM31C5C1H683JA01L
82000pF(823)	±5%(J)				GRM31C5C1H823JA01L
100000pF(104)	±5%(J)				GRM31C5C1H104JA01L

品名代号在()中注明，单位在 []中注明。< >: EIA [英寸] 代号

- (品名) GR M 21 6 5C 2A 101 J A01 D ①型号 ②系列 ③尺寸(长×宽) ④尺寸(厚度) ⑤温度特性
 ⑥额定电压 ⑦静电容量 ⑧静电容量公差 ⑨个别规格代号 ⑩包装

品名中的包装代号表示标准180mm卷盘。

温度补偿型 C0G(5C) 特性 薄型

长x宽 [mm]		1.0x0.5(15)<0402>
额定电压 [Vdc]		50(1H)
静电容量	公差	品名
0.1pF(R10)	±0.1pF(B)	GRM1535C1HR10BDD5D
0.2pF(R20)	±0.1pF(B)	GRM1535C1HR20BDD5D
0.3pF(R30)	±0.1pF(B)	GRM1535C1HR30BDD5D
0.4pF(R40)	±0.1pF(B)	GRM1535C1HR40BDD5D
0.5pF(R50)	±0.1pF(B)	GRM1535C1HR50BDD5D
0.6pF(R60)	±0.1pF(B)	GRM1535C1HR60BDD5D
0.7pF(R70)	±0.1pF(B)	GRM1535C1HR70BDD5D
0.8pF(R80)	±0.1pF(B)	GRM1535C1HR80BDD5D
0.9pF(R90)	±0.1pF(B)	GRM1535C1HR90BDD5D
1.0pF(1R0)	±0.25pF(C)	GRM1535C1H1R0CDD5D
1.1pF(1R1)	±0.25pF(C)	GRM1535C1H1R1CDD5D
1.2pF(1R2)	±0.25pF(C)	GRM1535C1H1R2CDD5D
1.3pF(1R3)	±0.25pF(C)	GRM1535C1H1R3CDD5D
1.4pF(1R4)	±0.25pF(C)	GRM1535C1H1R4CDD5D
1.5pF(1R5)	±0.25pF(C)	GRM1535C1H1R5CDD5D
1.6pF(1R6)	±0.25pF(C)	GRM1535C1H1R6CDD5D
1.7pF(1R7)	±0.25pF(C)	GRM1535C1H1R7CDD5D
1.8pF(1R8)	±0.25pF(C)	GRM1535C1H1R8CDD5D
1.9pF(1R9)	±0.25pF(C)	GRM1535C1H1R9CDD5D
2.0pF(2R0)	±0.25pF(C)	GRM1535C1H2R0CDD5D
2.1pF(2R1)	±0.25pF(C)	GRM1535C1H2R1CDD5D
2.2pF(2R2)	±0.25pF(C)	GRM1535C1H2R2CDD5D
2.3pF(2R3)	±0.25pF(C)	GRM1535C1H2R3CDD5D
2.4pF(2R4)	±0.25pF(C)	GRM1535C1H2R4CDD5D
2.5pF(2R5)	±0.25pF(C)	GRM1535C1H2R5CDD5D
2.6pF(2R6)	±0.25pF(C)	GRM1535C1H2R6CDD5D
2.7pF(2R7)	±0.25pF(C)	GRM1535C1H2R7CDD5D
2.8pF(2R8)	±0.25pF(C)	GRM1535C1H2R8CDD5D
2.9pF(2R9)	±0.25pF(C)	GRM1535C1H2R9CDD5D
3.0pF(3R0)	±0.25pF(C)	GRM1535C1H3R0CDD5D
3.1pF(3R1)	±0.25pF(C)	GRM1535C1H3R1CDD5D
3.2pF(3R2)	±0.25pF(C)	GRM1535C1H3R2CDD5D
3.3pF(3R3)	±0.25pF(C)	GRM1535C1H3R3CDD5D
3.4pF(3R4)	±0.25pF(C)	GRM1535C1H3R4CDD5D
3.5pF(3R5)	±0.25pF(C)	GRM1535C1H3R5CDD5D
3.6pF(3R6)	±0.25pF(C)	GRM1535C1H3R6CDD5D
3.7pF(3R7)	±0.25pF(C)	GRM1535C1H3R7CDD5D
3.8pF(3R8)	±0.25pF(C)	GRM1535C1H3R8CDD5D
3.9pF(3R9)	±0.25pF(C)	GRM1535C1H3R9CDD5D
4.0pF(4R0)	±0.25pF(C)	GRM1535C1H4R0CDD5D
4.1pF(4R1)	±0.25pF(C)	GRM1535C1H4R1CDD5D
4.2pF(4R2)	±0.25pF(C)	GRM1535C1H4R2CDD5D
4.3pF(4R3)	±0.25pF(C)	GRM1535C1H4R3CDD5D
4.4pF(4R4)	±0.25pF(C)	GRM1535C1H4R4CDD5D
4.5pF(4R5)	±0.25pF(C)	GRM1535C1H4R5CDD5D
4.6pF(4R6)	±0.25pF(C)	GRM1535C1H4R6CDD5D
4.7pF(4R7)	±0.25pF(C)	GRM1535C1H4R7CDD5D
4.8pF(4R8)	±0.25pF(C)	GRM1535C1H4R8CDD5D
4.9pF(4R9)	±0.25pF(C)	GRM1535C1H4R9CDD5D
5.0pF(5R0)	±0.25pF(C)	GRM1535C1H5R0CDD5D

长x宽 [mm]		1.0x0.5(15)<0402>
额定电压 [Vdc]		50(1H)
静电容量	公差	品名
5.1pF(5R1)	±0.5pF(D)	GRM1535C1H5R1DDD5D
5.2pF(5R2)	±0.5pF(D)	GRM1535C1H5R2DDD5D
5.3pF(5R3)	±0.5pF(D)	GRM1535C1H5R3DDD5D
5.4pF(5R4)	±0.5pF(D)	GRM1535C1H5R4DDD5D
5.5pF(5R5)	±0.5pF(D)	GRM1535C1H5R5DDD5D
5.6pF(5R6)	±0.5pF(D)	GRM1535C1H5R6DDD5D
5.7pF(5R7)	±0.5pF(D)	GRM1535C1H5R7DDD5D
5.8pF(5R8)	±0.5pF(D)	GRM1535C1H5R8DDD5D
5.9pF(5R9)	±0.5pF(D)	GRM1535C1H5R9DDD5D
6.0pF(6R0)	±0.5pF(D)	GRM1535C1H6R0DDD5D
6.1pF(6R1)	±0.5pF(D)	GRM1535C1H6R1DDD5D
6.2pF(6R2)	±0.5pF(D)	GRM1535C1H6R2DDD5D
6.3pF(6R3)	±0.5pF(D)	GRM1535C1H6R3DDD5D
6.4pF(6R4)	±0.5pF(D)	GRM1535C1H6R4DDD5D
6.5pF(6R5)	±0.5pF(D)	GRM1535C1H6R5DDD5D
6.6pF(6R6)	±0.5pF(D)	GRM1535C1H6R6DDD5D
6.7pF(6R7)	±0.5pF(D)	GRM1535C1H6R7DDD5D
6.8pF(6R8)	±0.5pF(D)	GRM1535C1H6R8DDD5D
6.9pF(6R9)	±0.5pF(D)	GRM1535C1H6R9DDD5D
7.0pF(7R0)	±0.5pF(D)	GRM1535C1H7R0DDD5D
7.1pF(7R1)	±0.5pF(D)	GRM1535C1H7R1DDD5D
7.2pF(7R2)	±0.5pF(D)	GRM1535C1H7R2DDD5D
7.3pF(7R3)	±0.5pF(D)	GRM1535C1H7R3DDD5D
7.4pF(7R4)	±0.5pF(D)	GRM1535C1H7R4DDD5D
7.5pF(7R5)	±0.5pF(D)	GRM1535C1H7R5DDD5D
7.6pF(7R6)	±0.5pF(D)	GRM1535C1H7R6DDD5D
7.7pF(7R7)	±0.5pF(D)	GRM1535C1H7R7DDD5D
7.8pF(7R8)	±0.5pF(D)	GRM1535C1H7R8DDD5D
7.9pF(7R9)	±0.5pF(D)	GRM1535C1H7R9DDD5D
8.0pF(8R0)	±0.5pF(D)	GRM1535C1H8R0DDD5D
8.1pF(8R1)	±0.5pF(D)	GRM1535C1H8R1DDD5D
8.2pF(8R2)	±0.5pF(D)	GRM1535C1H8R2DDD5D
8.3pF(8R3)	±0.5pF(D)	GRM1535C1H8R3DDD5D
8.4pF(8R4)	±0.5pF(D)	GRM1535C1H8R4DDD5D
8.5pF(8R5)	±0.5pF(D)	GRM1535C1H8R5DDD5D
8.6pF(8R6)	±0.5pF(D)	GRM1535C1H8R6DDD5D
8.7pF(8R7)	±0.5pF(D)	GRM1535C1H8R7DDD5D
8.8pF(8R8)	±0.5pF(D)	GRM1535C1H8R8DDD5D
8.9pF(8R9)	±0.5pF(D)	GRM1535C1H8R9DDD5D
9.0pF(9R0)	±0.5pF(D)	GRM1535C1H9R0DDD5D
9.1pF(9R1)	±0.5pF(D)	GRM1535C1H9R1DDD5D
9.2pF(9R2)	±0.5pF(D)	GRM1535C1H9R2DDD5D
9.3pF(9R3)	±0.5pF(D)	GRM1535C1H9R3DDD5D
9.4pF(9R4)	±0.5pF(D)	GRM1535C1H9R4DDD5D
9.5pF(9R5)	±0.5pF(D)	GRM1535C1H9R5DDD5D
9.6pF(9R6)	±0.5pF(D)	GRM1535C1H9R6DDD5D
9.7pF(9R7)	±0.5pF(D)	GRM1535C1H9R7DDD5D
9.8pF(9R8)	±0.5pF(D)	GRM1535C1H9R8DDD5D
9.9pF(9R9)	±0.5pF(D)	GRM1535C1H9R9DDD5D

品名代号在()中注明，单位在 []中注明。< >: EIA [英寸] 代号

温度补偿型 C0G(5C) 特性 薄型

长x宽 [mm]		1.0x0.5(15)<0402>
额定电压 [Vdc]		50(1H)
静电容量	公差	品名
10pF(100)	±5%(J)	GRM1535C1H100JDD5D
12pF(120)	±5%(J)	GRM1535C1H120JDD5D
15pF(150)	±5%(J)	GRM1535C1H150JDD5D
18pF(180)	±5%(J)	GRM1535C1H180JDD5D
22pF(220)	±5%(J)	GRM1535C1H220JDD5D
27pF(270)	±5%(J)	GRM1535C1H270JDD5D
33pF(330)	±5%(J)	GRM1535C1H330JDD5D
39pF(390)	±5%(J)	GRM1535C1H390JDD5D
47pF(470)	±5%(J)	GRM1535C1H470JDD5D
56pF(560)	±5%(J)	GRM1535C1H560JDD5D
68pF(680)	±5%(J)	GRM1535C1H680JDD5D
82pF(820)	±5%(J)	GRM1535C1H820JDD5D
100pF(101)	±5%(J)	GRM1535C1H101JDD5D
120pF(121)	±5%(J)	GRM1535C1H121JDD5D
150pF(151)	±5%(J)	GRM1535C1H151JDD5D
180pF(181)	±5%(J)	GRM1535C1H181JDD5D
220pF(221)	±5%(J)	GRM1535C1H221JDD5D
270pF(271)	±5%(J)	GRM1535C1H271JDD5D
330pF(331)	±5%(J)	GRM1535C1H331JDD5D
390pF(391)	±5%(J)	GRM1535C1H391JDD5D
470pF(471)	±5%(J)	GRM1535C1H471JDD5D
560pF(561)	±5%(J)	GRM1535C1H561JDD5D
680pF(681)	±5%(J)	GRM1535C1H681JDD5D

品名代号在()中注明，单位在 []中注明。< >: EIA [英寸] 代号



- (品名) GR M 15 3 5C 1H 100 J DD5 D ①型号 ②系列 ③尺寸(长×宽) ④尺寸(厚度) ⑤温度特性
 ⑥额定电压 ⑦静电容量 ⑧静电容量公差 ⑨个别规格代号 ⑩包装

品名中的包装代号表示标准180mm卷盘。

温度补偿型 C0G(5C) 特性 薄型

长x宽 [mm]		2.0x1.25(21)<0805>		3.2x1.6(31)<1206>	
额定电压 [Vdc]		100(2A)	50(1H)	100(2A)	50(1H)
静电容量	公差	品名			
100pF(101)	±5%(J)	GRM2165C2A101JA01D			
120pF(121)	±5%(J)	GRM2165C2A121JA01D			
150pF(151)	±5%(J)	GRM2165C2A151JA01D			
180pF(181)	±5%(J)	GRM2165C2A181JA01D			
220pF(221)	±5%(J)	GRM2165C2A221JA01D			
270pF(271)	±5%(J)	GRM2165C2A271JA01D			
330pF(331)	±5%(J)	GRM2165C2A331JA01D			
390pF(391)	±5%(J)	GRM2165C2A391JA01D			
470pF(471)	±5%(J)	GRM2165C2A471JA01D			
560pF(561)	±5%(J)	GRM2165C2A561JA01D			
680pF(681)	±5%(J)	GRM2165C2A681JA01D			
820pF(821)	±5%(J)	GRM2165C2A821JA01D			
1000pF(102)	±5%(J)	GRM2165C2A102JA01D			
1200pF(122)	±5%(J)	GRM2165C2A122JA01D	GRM2165C1H122JA01D		
1500pF(152)	±5%(J)	GRM2165C2A152JA01D	GRM2165C1H152JA01D		
1800pF(182)	±5%(J)	GRM2165C2A182JA01D	GRM2165C1H182JA01D	GRM3195C2A182JA01D	
2200pF(222)	±5%(J)	GRM2165C2A222JA01D	GRM2165C1H222JA01D	GRM3195C2A222JA01D	
2700pF(272)	±5%(J)	GRM2165C2A272JA01D	GRM2165C1H272JA01D	GRM3195C2A272JA01D	
3300pF(332)	±5%(J)	GRM2165C2A332JA01D	GRM2165C1H332JA01D	GRM3195C2A332JA01D	
3900pF(392)	±5%(J)		GRM2165C1H392JA01D	GRM3195C2A392JA01D	
4700pF(472)	±5%(J)		GRM2165C1H472JA01D	GRM3195C2A472JA01D	GRM3195C1H472JA01D
5600pF(562)	±5%(J)		GRM2195C1H562JA01D	GRM3195C2A562JA01D	GRM3195C1H562JA01D
6800pF(682)	±5%(J)		GRM2195C1H682JA01D	GRM3195C2A682JA01D	GRM3195C1H682JA01D
8200pF(822)	±5%(J)		GRM2195C1H822JA01D	GRM3195C2A822JA01D	GRM3195C1H822JA01D
10000pF(103)	±5%(J)		GRM2195C1H103JA01D	GRM3195C2A103JA01D	GRM3195C1H103JA01D
12000pF(123)	±5%(J)		GRM2195C1H123JA01D		GRM3195C1H123JA01D
15000pF(153)	±5%(J)		GRM2195C1H153JA01D		GRM3195C1H153JA01D
18000pF(183)	±5%(J)				GRM3195C1H183JA01D
22000pF(223)	±5%(J)				GRM3195C1H223JA01D
27000pF(273)	±5%(J)				GRM3195C1H273JA01D
33000pF(333)	±5%(J)				GRM3195C1H333JA01D
39000pF(393)	±5%(J)				GRM3195C1H393JA01D
47000pF(473)	±5%(J)				GRM31M5C1H473JA01L
56000pF(563)	±5%(J)				GRM31M5C1H563JA01L

品名代号在()中注明，单位在[]中注明。<>: EIA [英寸] 代号

温度补偿型 U2J(7U) 特性

长x宽 [mm]		0.6x0.3(03)<0201>		1.0x0.5(15)<0402>	
额定电压 [Vdc]		50(1H)	25(1E)	50(1H)	10(1A)
静电容量	公差	品名			
1.0pF(1R0)	±0.25pF(C)	GRM0337U1H1R0CD01D		GRM1557U1H1R0CZ01D	
2.0pF(2R0)	±0.25pF(C)	GRM0337U1H2R0CD01D		GRM1557U1H2R0CZ01D	
3.0pF(3R0)	±0.25pF(C)	GRM0337U1H3R0CD01D		GRM1557U1H3R0CZ01D	
4.0pF(4R0)	±0.25pF(C)	GRM0337U1H4R0CD01D		GRM1557U1H4R0CZ01D	
5.0pF(5R0)	±0.25pF(C)	GRM0337U1H5R0CD01D		GRM1557U1H5R0CZ01D	
6.0pF(6R0)	±0.5pF(D)	GRM0337U1H6R0DD01D		GRM1557U1H6R0DZ01D	
7.0pF(7R0)	±0.5pF(D)	GRM0337U1H7R0DD01D		GRM1557U1H7R0DZ01D	
8.0pF(8R0)	±0.5pF(D)	GRM0337U1H8R0DD01D		GRM1557U1H8R0DZ01D	
9.0pF(9R0)	±0.5pF(D)	GRM0337U1H9R0DD01D		GRM1557U1H9R0DZ01D	
10pF(100)	±5%(J)	GRM0337U1H100JD01D		GRM1557U1H100JZ01D	
12pF(120)	±5%(J)	GRM0337U1H120JD01D		GRM1557U1H120JZ01D	
15pF(150)	±5%(J)	GRM0337U1H150JD01D		GRM1557U1H150JZ01D	
18pF(180)	±5%(J)		GRM0337U1E180JD01D	GRM1557U1H180JZ01D	
22pF(220)	±5%(J)		GRM0337U1E220JD01D	GRM1557U1H220JZ01D	
27pF(270)	±5%(J)		GRM0337U1E270JD01D	GRM1557U1H270JZ01D	
33pF(330)	±5%(J)		GRM0337U1E330JD01D	GRM1557U1H330JZ01D	
39pF(390)	±5%(J)		GRM0337U1E390JD01D	GRM1557U1H390JZ01D	
47pF(470)	±5%(J)		GRM0337U1E470JD01D	GRM1557U1H470JZ01D	
56pF(560)	±5%(J)		GRM0337U1E560JD01D	GRM1557U1H560JZ01D	
68pF(680)	±5%(J)		GRM0337U1E680JD01D	GRM1557U1H680JZ01D	
82pF(820)	±5%(J)		GRM0337U1E820JD01D	GRM1557U1H820JZ01D	
100pF(101)	±5%(J)		GRM0337U1E101JD01D	GRM1557U1H101JZ01D	
120pF(121)	±5%(J)			GRM1557U1H121JZ01D	
150pF(151)	±5%(J)			GRM1557U1H151JZ01D	
180pF(181)	±5%(J)			GRM1557U1H181JZ01D	
1200pF(122)	±5%(J)				GRM1557U1A122JA01D
1500pF(152)	±5%(J)				GRM1557U1A152JA01D
1800pF(182)	±5%(J)				GRM1557U1A182JA01D
2200pF(222)	±5%(J)				GRM1557U1A222JA01D
2700pF(272)	±5%(J)				GRM1557U1A272JA01D
3300pF(332)	±5%(J)				GRM1557U1A332JA01D
3900pF(392)	±5%(J)				GRM1557U1A392JA01D
4700pF(472)	±5%(J)				GRM1557U1A472JA01D

品名代号在()中注明，单位在 []中注明。< >: EIA [英寸] 代号

(品名) GR M 03 3 7U 1H 1R0 C D01 D ①型号 ②系列 ③尺寸(长×宽) ④尺寸(厚度) ⑤温度特性
⑥额定电压 ⑦静电容量 ⑧静电容量公差 ⑨个别规格代号 ⑩包装

品名中的包装代号表示标准180mm卷盘。

温度补偿型 U2J(7U) 特性

长x宽 [mm]		1.6x0.8(18)<0603>	
额定电压 [Vdc]		50(1H)	10(1A)
静电容量	公差	品名	
1000pF(102)	±5%(J)	GRM1887U1H102JA01D	
1200pF(122)	±5%(J)	GRM1887U1H122JA01D	
1500pF(152)	±5%(J)	GRM1887U1H152JA01D	
1800pF(182)	±5%(J)	GRM1887U1H182JA01D	
2200pF(222)	±5%(J)	GRM1887U1H222JA01D	
2700pF(272)	±5%(J)	GRM1887U1H272JA01D	
3300pF(332)	±5%(J)	GRM1887U1H332JA01D	
3900pF(392)	±5%(J)	GRM1887U1H392JA01D	
4700pF(472)	±5%(J)	GRM1887U1H472JA01D	
5600pF(562)	±5%(J)	GRM1887U1H562JA01D	
6800pF(682)	±5%(J)	GRM1887U1H682JA01D	
8200pF(822)	±5%(J)	GRM1887U1H822JA01D	
10000pF(103)	±5%(J)	GRM1887U1H103JA01D	
12000pF(123)	±5%(J)		GRM1887U1A123JA01D
15000pF(153)	±5%(J)		GRM1887U1A153JA01D
18000pF(183)	±5%(J)		GRM1887U1A183JA01D
22000pF(223)	±5%(J)		GRM1887U1A223JA01D

长x宽 [mm]		2.0x1.25(21)<0805>		3.2x1.6(31)<1206>
额定电压 [Vdc]		50(1H)	10(1A)	50(1H)
静电容量	公差	品名		
10000pF(103)	±5%(J)	GRM2167U1H103JA01D		
12000pF(123)	±5%(J)	GRM2167U1H123JA01D		
15000pF(153)	±5%(J)	GRM2167U1H153JA01D		
18000pF(183)	±5%(J)	GRM2167U1H183JA01D		
22000pF(223)	±5%(J)	GRM2197U1H223JA01D		
27000pF(273)	±5%(J)	GRM2197U1H273JA01D		
33000pF(333)	±5%(J)	GRM21A7U1H333JA39L		
39000pF(393)	±5%(J)	GRM21B7U1H393JA01L		
47000pF(473)	±5%(J)	GRM21B7U1H473JA01L		
56000pF(563)	±5%(J)		GRM2197U1A563JA01D	GRM3197U1H563JA01D
68000pF(683)	±5%(J)		GRM21B7U1A683JA01L	GRM31M7U1H683JA01L
82000pF(823)	±5%(J)		GRM21B7U1A823JA01L	GRM31M7U1H823JA01L
100000pF(104)	±5%(J)		GRM21B7U1A104JA01L	GRM31M7U1H104JA01L

品名代号在()中注明，单位在 []中注明。< >: EIA [英寸] 代号

温度补偿型 U2J(7U) 特性 薄型

长x宽 [mm]		1.6x0.8(18)<0603>	
额定电压 [Vdc]		50(1H)	10(1A)
静电容量	公差	品名	
2200pF(222)	±5%(J)	GRM1857U1H222JA44D	
2700pF(272)	±5%(J)	GRM1857U1H272JA44D	
3300pF(332)	±5%(J)	GRM1857U1H332JA44D	
3900pF(392)	±5%(J)	GRM1857U1H392JA44D	
4700pF(472)	±5%(J)	GRM1857U1H472JA44D	
5600pF(562)	±5%(J)	GRM1857U1A562JA44D	
6800pF(682)	±5%(J)	GRM1857U1A682JA44D	
8200pF(822)	±5%(J)	GRM1857U1A822JA44D	
10000pF(103)	±5%(J)	GRM1857U1A103JA44D	

长x宽 [mm]		2.0x1.25(21)<0805>		3.2x1.6(31)<1206>	
额定电压 [Vdc]		50(1H)	10(1A)	50(1H)	
静电容量	公差	品名			
10000pF(103)	±5%(J)	GRM2167U1H103JA01D			
12000pF(123)	±5%(J)	GRM2167U1H123JA01D			
15000pF(153)	±5%(J)	GRM2167U1H153JA01D			
18000pF(183)	±5%(J)	GRM2167U1H183JA01D			
22000pF(223)	±5%(J)	GRM2197U1H223JA01D			
27000pF(273)	±5%(J)	GRM2197U1H273JA01D			
33000pF(333)	±5%(J)	GRM21A7U1H333JA39L			
56000pF(563)	±5%(J)	GRM2197U1A563JA01D		GRM3197U1H563JA01D	
68000pF(683)	±5%(J)			GRM31M7U1H683JA01L	
82000pF(823)	±5%(J)			GRM31M7U1H823JA01L	
100000pF(104)	±5%(J)			GRM31M7U1H104JA01L	

品名代号在()中注明，单位在 []中注明。< >: EIA [英寸] 代号

(品名) GR M 18 5 7U 1H 222 J A44 D
 ① ② ③ ④ ⑤ ⑥ ⑦ ⑧ ⑨ ⑩

① 型号 ② 系列 ③ 尺寸 (长 × 宽) ④ 尺寸 (厚度) ⑤ 温度特性
 ⑥ 额定电压 ⑦ 静电容量 ⑧ 静电容量公差 ⑨ 个别规格代号 ⑩ 包装

品名中的包装代号表示标准180mm卷盘。

温度补偿型 P2H(6P) 特性

长x宽 [mm]		1.0x0.5(15)<0402>
额定电压 [Vdc]		50(1H)
静电容量	公差	品名
1.0pF(1R0)	±0.25pF(C)	GRM1556P1H1R0CZ01D
2.0pF(2R0)	±0.25pF(C)	GRM1556P1H2R0CZ01D
3.0pF(3R0)	±0.25pF(C)	GRM1556P1H3R0CZ01D
4.0pF(4R0)	±0.25pF(C)	GRM1556P1H4R0CZ01D
5.0pF(5R0)	±0.25pF(C)	GRM1556P1H5R0CZ01D
6.0pF(6R0)	±0.5pF(D)	GRM1556P1H6R0DZ01D
7.0pF(7R0)	±0.5pF(D)	GRM1556P1H7R0DZ01D
8.0pF(8R0)	±0.5pF(D)	GRM1556P1H8R0DZ01D
9.0pF(9R0)	±0.5pF(D)	GRM1556P1H9R0DZ01D
10pF(100)	±5%(J)	GRM1556P1H100JZ01D
12pF(120)	±5%(J)	GRM1556P1H120JZ01D
15pF(150)	±5%(J)	GRM1556P1H150JZ01D
18pF(180)	±5%(J)	GRM1556P1H180JZ01D
22pF(220)	±5%(J)	GRM1556P1H220JZ01D
27pF(270)	±5%(J)	GRM1556P1H270JZ01D

品名代号在()中注明，单位在 []中注明。< >: EIA [英寸] 代号

温度补偿型 R2H(6R) 特性

长x宽 [mm]		0.6x0.3(03)<0201>	1.0x0.5(15)<0402>
额定电压 [Vdc]		25(1E)	50(1H)
静电容量	公差	品名	
1.0pF(1R0)	±0.25pF(C)	GRM0336R1E1R0CD01D	GRM1556R1H1R0CD01D
2.0pF(2R0)	±0.25pF(C)	GRM0336R1E2R0CD01D	GRM1556R1H2R0CZ01D
3.0pF(3R0)	±0.25pF(C)	GRM0336R1E3R0CD01D	GRM1556R1H3R0CZ01D
4.0pF(4R0)	±0.25pF(C)	GRM0336R1E4R0CD01D	GRM1556R1H4R0CZ01D
5.0pF(5R0)	±0.25pF(C)	GRM0336R1E5R0CD01D	GRM1556R1H5R0CZ01D
6.0pF(6R0)	±0.5pF(D)	GRM0336R1E6R0DD01D	GRM1556R1H6R0DZ01D
7.0pF(7R0)	±0.5pF(D)	GRM0336R1E7R0DD01D	GRM1556R1H7R0DZ01D
8.0pF(8R0)	±0.5pF(D)	GRM0336R1E8R0DD01D	GRM1556R1H8R0DZ01D
9.0pF(9R0)	±0.5pF(D)	GRM0336R1E9R0DD01D	GRM1556R1H9R0DZ01D
10pF(100)	±5%(J)	GRM0336R1E100JD01D	GRM1556R1H100JZ01D
12pF(120)	±5%(J)	GRM0336R1E120JD01D	GRM1556R1H120JZ01D
15pF(150)	±5%(J)	GRM0336R1E150JD01D	GRM1556R1H150JZ01D
18pF(180)	±5%(J)	GRM0336R1E180JD01D	GRM1556R1H180JZ01D
22pF(220)	±5%(J)	GRM0336R1E220JD01D	GRM1556R1H220JZ01D
27pF(270)	±5%(J)	GRM0336R1E270JD01D	GRM1556R1H270JZ01D
33pF(330)	±5%(J)	GRM0336R1E330JD01D	GRM1556R1H330JZ01D
39pF(390)	±5%(J)	GRM0336R1E390JD01D	
47pF(470)	±5%(J)	GRM0336R1E470JD01D	
56pF(560)	±5%(J)	GRM0336R1E560JD01D	
68pF(680)	±5%(J)	GRM0336R1E680JD01D	
82pF(820)	±5%(J)	GRM0336R1E820JD01D	
100pF(101)	±5%(J)	GRM0336R1E101JD01D	

品名代号在()中注明，单位在 []中注明。< >: EIA [英寸] 代号

温度补偿型 S2H(6S) 特性

长x宽 [mm]		0.6x0.3(03)<0201>	1.0x0.5(15)<0402>
额定电压 [Vdc]		25(1E)	50(1H)
静电容量	公差	品名	
1.0pF(1R0)	±0.25pF(C)	GRM0336S1E1R0CD01D	GRM1556S1H1R0CD01D
2.0pF(2R0)	±0.25pF(C)	GRM0336S1E2R0CD01D	GRM1556S1H2R0CZ01D
3.0pF(3R0)	±0.25pF(C)	GRM0336S1E3R0CD01D	GRM1556S1H3R0CZ01D
4.0pF(4R0)	±0.25pF(C)	GRM0336S1E4R0CD01D	GRM1556S1H4R0CZ01D
5.0pF(5R0)	±0.25pF(C)	GRM0336S1E5R0CD01D	GRM1556S1H5R0CZ01D
6.0pF(6R0)	±0.5pF(D)	GRM0336S1E6R0DD01D	GRM1556S1H6R0DZ01D
7.0pF(7R0)	±0.5pF(D)	GRM0336S1E7R0DD01D	GRM1556S1H7R0DZ01D
8.0pF(8R0)	±0.5pF(D)	GRM0336S1E8R0DD01D	GRM1556S1H8R0DZ01D
9.0pF(9R0)	±0.5pF(D)	GRM0336S1E9R0DD01D	GRM1556S1H9R0DZ01D
10pF(100)	±5%(J)	GRM0336S1E100JD01D	GRM1556S1H100JZ01D
12pF(120)	±5%(J)	GRM0336S1E120JD01D	GRM1556S1H120JZ01D
15pF(150)	±5%(J)	GRM0336S1E150JD01D	GRM1556S1H150JZ01D
18pF(180)	±5%(J)	GRM0336S1E180JD01D	GRM1556S1H180JZ01D
22pF(220)	±5%(J)	GRM0336S1E220JD01D	GRM1556S1H220JZ01D
27pF(270)	±5%(J)	GRM0336S1E270JD01D	GRM1556S1H270JZ01D
33pF(330)	±5%(J)	GRM0336S1E330JD01D	GRM1556S1H330JZ01D
39pF(390)	±5%(J)	GRM0336S1E390JD01D	GRM1556S1H390JZ01D
47pF(470)	±5%(J)	GRM0336S1E470JD01D	
56pF(560)	±5%(J)	GRM0336S1E560JD01D	
68pF(680)	±5%(J)	GRM0336S1E680JD01D	
82pF(820)	±5%(J)	GRM0336S1E820JD01D	
100pF(101)	±5%(J)	GRM0336S1E101JD01D	

品名代号在()中注明，单位在 []中注明。< >: EIA [英寸] 代号

(品名) GR M 03 3 6S 1E 1R0 C D01 D ①型号 ②系列 ③尺寸(长×宽) ④尺寸(厚度) ⑤温度特性
 ⑥额定电压 ⑦静电容量 ⑧静电容量公差 ⑨个别规格代号 ⑩包装

品名中的包装代号表示标准180mm卷盘。

温度补偿型 T2H(6T) 特性

长x宽 [mm]		0.6x0.3(03)<0201>	1.0x0.5(15)<0402>
额定电压 [Vdc]		25(1E)	50(1H)
静电容量	公差	品名	
1.0pF(1R0)	±0.25pF(C)	GRM0336T1E1R0CD01D	GRM1556T1H1R0CD01D
2.0pF(2R0)	±0.25pF(C)	GRM0336T1E2R0CD01D	GRM1556T1H2R0CD01D
3.0pF(3R0)	±0.25pF(C)	GRM0336T1E3R0CD01D	GRM1556T1H3R0CD01D
4.0pF(4R0)	±0.25pF(C)	GRM0336T1E4R0CD01D	GRM1556T1H4R0CD01D
5.0pF(5R0)	±0.25pF(C)	GRM0336T1E5R0CD01D	GRM1556T1H5R0CD01D
6.0pF(6R0)	±0.5pF(D)	GRM0336T1E6R0DD01D	GRM1556T1H6R0DD01D
7.0pF(7R0)	±0.5pF(D)	GRM0336T1E7R0DD01D	GRM1556T1H7R0DD01D
8.0pF(8R0)	±0.5pF(D)	GRM0336T1E8R0DD01D	GRM1556T1H8R0DD01D
9.0pF(9R0)	±0.5pF(D)	GRM0336T1E9R0DD01D	GRM1556T1H9R0DD01D
10pF(100)	±5%(J)	GRM0336T1E100JD01D	GRM1556T1H100JD01D
12pF(120)	±5%(J)	GRM0336T1E120JD01D	GRM1556T1H120JD01D
15pF(150)	±5%(J)	GRM0336T1E150JD01D	GRM1556T1H150JD01D
18pF(180)	±5%(J)	GRM0336T1E180JD01D	GRM1556T1H180JD01D
22pF(220)	±5%(J)	GRM0336T1E220JD01D	GRM1556T1H220JD01D
27pF(270)	±5%(J)	GRM0336T1E270JD01D	GRM1556T1H270JD01D
33pF(330)	±5%(J)	GRM0336T1E330JD01D	GRM1556T1H330JD01D
39pF(390)	±5%(J)	GRM0336T1E390JD01D	GRM1556T1H390JD01D
47pF(470)	±5%(J)	GRM0336T1E470JD01D	GRM1556T1H470JD01D
56pF(560)	±5%(J)	GRM0336T1E560JD01D	GRM1556T1H560JD01D
68pF(680)	±5%(J)	GRM0336T1E680JD01D	GRM1556T1H680JD01D
82pF(820)	±5%(J)	GRM0336T1E820JD01D	GRM1556T1H820JD01D
100pF(101)	±5%(J)	GRM0336T1E101JD01D	GRM1556T1H101JD01D

品名代号在()中注明，单位在 []中注明。< >: EIA [英寸] 代号



高介电常数型 X7R(R7) 特性

长x宽 [mm]	0.4x0.2(02)<01005>	
额定电压 [Vdc]	10(1A)	
静电容量	公差	品名
68pF(680)	±10%(K)	GRM022R71A680KA01L
100pF(101)	±10%(K)	GRM022R71A101KA01L
150pF(151)	±10%(K)	GRM022R71A151KA01L
220pF(221)	±10%(K)	GRM022R71A221KA01L
330pF(331)	±10%(K)	GRM022R71A331KA01L
470pF(471)	±10%(K)	GRM022R71A471KA01L

长x宽 [mm]	0.6x0.3(03)<0201>		
额定电压 [Vdc]	25(1E)	16(1C)	10(1A)
静电容量	公差	品名	
100pF(101)	±10%(K)	GRM033R71E101KA01D	
150pF(151)	±10%(K)	GRM033R71E151KA01D	
220pF(221)	±10%(K)	GRM033R71E221KA01D	
330pF(331)	±10%(K)	GRM033R71E331KA01D	
470pF(471)	±10%(K)	GRM033R71E471KA01D	
680pF(681)	±10%(K)	GRM033R71E681KA01D	
1000pF(102)	±10%(K)	GRM033R71E102KA01D	
1500pF(152)	±10%(K)	GRM033R71E152KA01D	
2200pF(222)	±10%(K)		GRM033R71C222KA88D
3300pF(332)	±10%(K)		GRM033R71C332KA88D
4700pF(472)	±10%(K)		GRM033R71A472KA01D
6800pF(682)	±10%(K)		GRM033R71A682KA01D
10000pF(103)	±10%(K)		GRM033R71A103KA01D

品名代号在()中注明，单位在 []中注明。< >: EIA [英寸] 代号

(品名) **GR** **M** **02** **2** **R7** **1A** **680** **K** **A01** **L** ①型号 ②系列 ③尺寸(长×宽) ④尺寸(厚度) ⑤温度特性
 ⑥额定电压 ⑦静电容量 ⑧静电容量公差 ⑨个别规格代号 ⑩包装*

品名中的包装代号表示标准180mm卷盘。

*GRM022: 可适用D代码包装方式。

高介电常数型 X7R(R7) 特性

长x宽 [mm]		1.0x0.5(15)<0402>			
额定电压 [Vdc]		100(2A)	50(1H)	25(1E)	16(1C)
静电容量	公差	品名			
220pF(221)	±10%(K)	GRM155R72A221KA01D	GRM155R71H221KA01D		
330pF(331)	±10%(K)	GRM155R72A331KA01D	GRM155R71H331KA01D		
470pF(471)	±10%(K)	GRM155R72A471KA01D	GRM155R71H471KA01D		
680pF(681)	±10%(K)	GRM155R72A681KA01D	GRM155R71H681KA01D		
1000pF(102)	±10%(K)	GRM155R72A102KA01D	GRM155R71H102KA01D		
1500pF(152)	±10%(K)	GRM155R72A152KA01D	GRM155R71H152KA01D		
2200pF(222)	±10%(K)	GRM155R72A222KA01D	GRM155R71H222KA01D		
3300pF(332)	±10%(K)	GRM155R72A332KA01D	GRM155R71H332KA01D		
4700pF(472)	±10%(K)	GRM155R72A472KA01D	GRM155R71H472KA01D	GRM155R71E472KA01D	
6800pF(682)	±10%(K)		GRM155R71H682KA88D	GRM155R71E682KA01D	
10000pF(103)	±10%(K)		GRM155R71H103KA88D	GRM155R71E103KA01D	
15000pF(153)	±10%(K)		GRM155R71H153KA12D	GRM155R71E153KA61D	GRM155R71C153KA01D
22000pF(223)	±10%(K)		GRM155R71H223KA12D	GRM155R71E223KA61D	GRM155R71C223KA01D
33000pF(333)	±10%(K)			GRM155R71E333KA88D	GRM155R71C333KA01D
47000pF(473)	±10%(K)			GRM155R71E473KA88D	GRM155R71C473KA01D
68000pF(683)	±10%(K)				GRM155R71C683KA88D
0.10μF(104)	±10%(K)				GRM155R71C104KA88D

长x宽 [mm]		1.0x0.5(15)<0402>
额定电压 [Vdc]		10(1A)
静电容量	公差	品名
68000pF(683)	±10%(K)	GRM155R71A683KA01D
0.10μF(104)	±10%(K)	GRM155R71A104KA01D

品名代号在()中注明，单位在 []中注明。< >: EIA [英寸] 代号

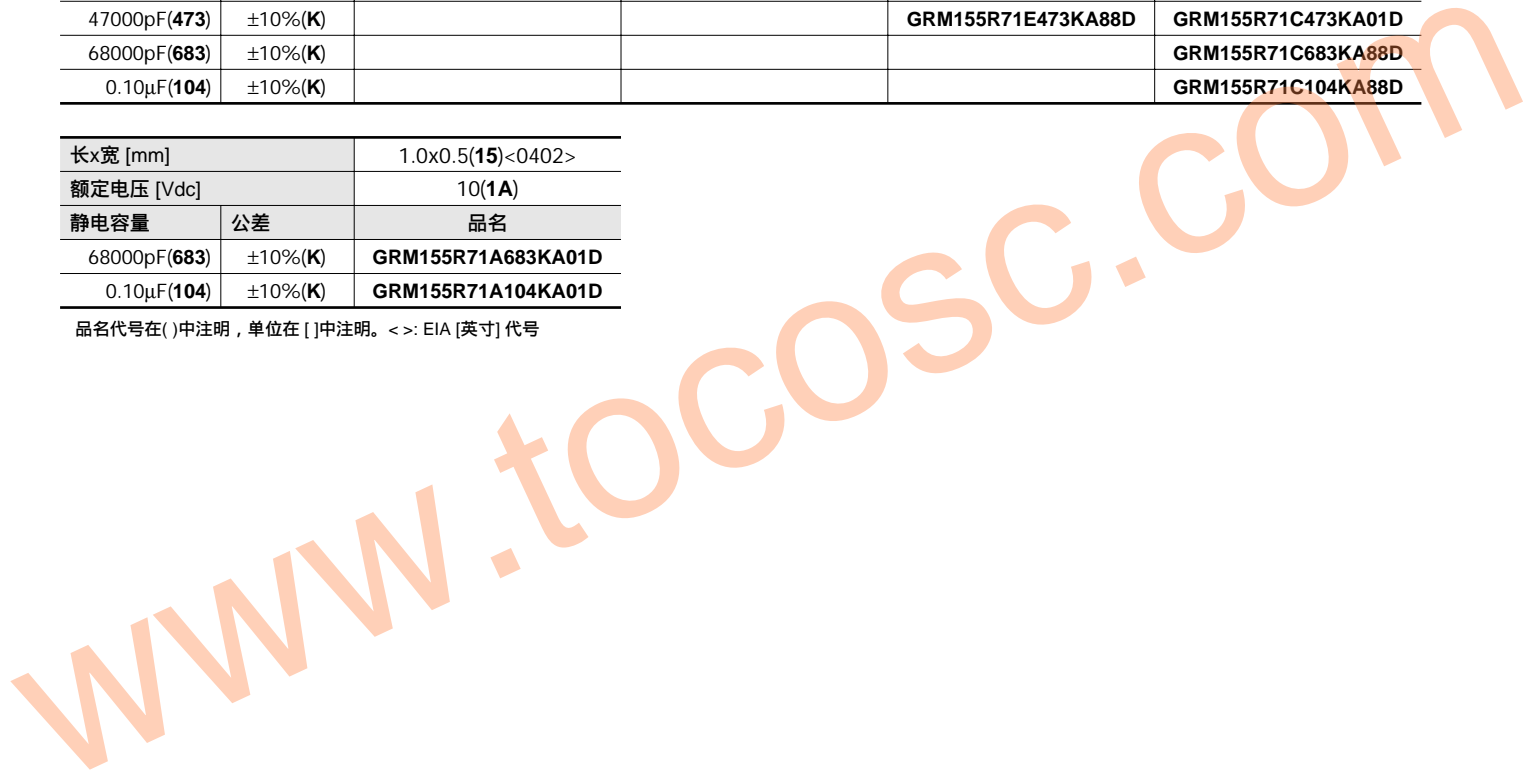

高介电常数型 X7R(R7)/X7S(C7) 特性

长x宽 [mm]		1.6x0.8(18)<0603>			
额定电压 [Vdc]		100(2A)	50(1H)	25(1E)	16(1C)
静电容量	公差	品名			
220pF(221)	±10%(K)	GRM188R72A221KA01D	GRM188R71H221KA01D		
330pF(331)	±10%(K)	GRM188R72A331KA01D	GRM188R71H331KA01D		
470pF(471)	±10%(K)	GRM188R72A471KA01D	GRM188R71H471KA01D		
680pF(681)	±10%(K)	GRM188R72A681KA01D	GRM188R71H681KA01D		
1000pF(102)	±10%(K)	GRM188R72A102KA01D	GRM188R71H102KA01D		
1500pF(152)	±10%(K)	GRM188R72A152KA01D	GRM188R71H152KA01D		
2200pF(222)	±10%(K)	GRM188R72A222KA01D	GRM188R71H222KA01D		
3300pF(332)	±10%(K)	GRM188R72A332KA01D	GRM188R71H332KA01D		
4700pF(472)	±10%(K)	GRM188R72A472KA01D	GRM188R71H472KA01D		
6800pF(682)	±10%(K)	GRM188R72A682KA01D	GRM188R71H682KA01D		
10000pF(103)	±10%(K)	GRM188R72A103KA01D	GRM188R71H103KA01D	GRM188R71E103KA01D	
15000pF(153)	±10%(K)		GRM188R71H153KA01D	GRM188R71E153KA01D	
22000pF(223)	±10%(K)		GRM188R71H223KA01D	GRM188R71E223KA01D	
33000pF(333)	±10%(K)		GRM188R71H333KA61D	GRM188R71E333KA01D	
47000pF(473)	±10%(K)		GRM188R71H473KA61D	GRM188R71E473KA01D	
68000pF(683)	±10%(K)		GRM188R71H683KA93D	GRM188R71E683KA01D	
0.10μF(104)	±10%(K)	GRM188R72A104KA35D	GRM188R71H104KA93D	GRM188R71E104KA01D	
0.15μF(154)	±10%(K)			GRM188R71E154KA01D	GRM188R71C154KA01D
0.22μF(224)	±10%(K)			GRM188R71E224KA88D	GRM188R71C224KA01D
0.33μF(334)	±10%(K)				GRM188R71C334KA01D
0.47μF(474)	±10%(K)			GRM188R71E474KA12D*	GRM188R71C474KA88D
1.0μF(105)	±10%(K)			GRM188R71E105KA12D*	GRM188R71C105KA12D*

长x宽 [mm]		1.6x0.8(18)<0603>		
额定电压 [Vdc]		10(1A)	6.3(0J)	4(0G)
静电容量	公差	品名		
0.33μF(334)	±10%(K)	GRM188R71A334KA61D		
0.47μF(474)	±10%(K)	GRM188R71A474KA61D		
0.68μF(684)	±10%(K)	GRM188R71A684KA61D		
1.0μF(105)	±10%(K)	GRM188R71A105KA61D*		
2.2μF(225)	±10%(K)	GRM188R71A225KE15D*	GRM188C70J225KE20D*	GRM188C70G225KE20D*

品名代号在()中注明，单位在 []中注明。< >: EIA [英寸] 代号

*: 请参见GRM系列规格和测试方法 (2)。

(品名) **GR** **M** **18** **8** **R7** **2A** **221** **K** **A01** **D** ①型号 ②系列 ③尺寸(长×宽) ④尺寸(厚度) ⑤温度特性
 ① ② ③ ④ ⑤ ⑥ ⑦ ⑧ ⑨ ⑩ ⑥额定电压 ⑦静电容量 ⑧静电容量公差 ⑨个别规格代号 ⑩包装

品名中的包装代号表示标准180mm卷盘。

高介电常数型 X7R(R7)/X7U(E7) 特性

长x宽 [mm]		2.0x1.25(21)<0805>			
额定电压 [Vdc]		100(2A)	50(1H)	25(1E)	16(1C)
静电容量	公差	品名			
6800pF(682)	±10%(K)	GRM219R72A682KA01D			
10000pF(103)	±10%(K)	GRM21BR72A103KA01L			
15000pF(153)	±10%(K)	GRM21BR72A153KA01L			
22000pF(223)	±10%(K)	GRM21BR72A223KA01L			
33000pF(333)	±10%(K)	GRM21BR72A333KA01L	GRM219R71H333KA01D		
47000pF(473)	±10%(K)	GRM21BR72A473KA01L	GRM21BR71H473KA01L		
68000pF(683)	±10%(K)		GRM21BR71H683KA01L	GRM219R71E683KA01D	
0.10μF(104)	±10%(K)		GRM21BR71H104KA01L	GRM21BR71E104KA01L	
0.15μF(154)	±10%(K)		GRM21BR71H154KA01L	GRM21BR71E154KA01L	
0.22μF(224)	±10%(K)	GRM21AR72A224KAC5L	GRM21BR71H224KA01L	GRM21BR71E224KA01L	
0.33μF(334)	±10%(K)	GRM21AR72A334KAC5L	GRM219R71H334KA88D	GRM21BR71E334KA01L	
0.47μF(474)	±10%(K)	GRM21BR72A474KA73L	GRM21BR71H474KA88L	GRM219R71E474KA88D	
0.68μF(684)	±10%(K)			GRM219R71E684KA88D	GRM219R71C684KA01D
1.0μF(105)	±10%(K)		GRM21BR71H105KA12L	GRM21BR71E105KA99L GRM219R71E105KA88D	GRM21BR71C105KA01L
2.2μF(225)	±10%(K)			GRM21BR71E225KA73L*	GRM21BR71C225KA12L
4.7μF(475)	±10%(K)				GRM21BR71C475KA73L*

长x宽 [mm]		2.0x1.25(21)<0805>		
额定电压 [Vdc]		10(1A)	6.3(0J)	4(0G)
静电容量	公差	品名		
2.2μF(225)	±10%(K)	GRM21BR71A225KA01L		
4.7μF(475)	±10%(K)	GRM21BR71A475KA73L*		
10μF(106)	±10%(K)	GRM21BR71A106KE51L*	GRM21BR70J106KE76L*	
22μF(226)	±20%(M)			GRM21BE70G226ME51L*

品名代号在()中注明，单位在 []中注明。< >: EIA [英寸] 代号

*: 请参见GRM系列规格和测试方法 (2)。

高介电常数型 X7R(R7)/X7U(E7) 特性

长x宽 [mm]		3.2x1.6(31)<1206>			
额定电压 [Vdc]		100(2A)	50(1H)	25(1E)	16(1C)
静电容量	公差	品名			
15000pF(153)	±10%(K)	GRM319R72A153KA01L			
22000pF(223)	±10%(K)	GRM31MR72A223KA01L			
33000pF(333)	±10%(K)	GRM31MR72A333KA01L			
47000pF(473)	±10%(K)	GRM31MR72A473KA01L			
68000pF(683)	±10%(K)	GRM31MR72A683KA01L			
0.10μF(104)	±10%(K)	GRM319R72A104KA01D			
0.15μF(154)	±10%(K)	GRM31MR72A154KA01L	GRM31MR71H154KA01L		
0.22μF(224)	±10%(K)	GRM31MR72A224KA01L	GRM31MR71H224KA01L		
0.33μF(334)	±10%(K)		GRM319R71H334KA01D		
0.47μF(474)	±10%(K)	GRM31MR72A474KA35L	GRM31MR71H474KA01L		
0.68μF(684)	±10%(K)	GRM31MR72A684KA35L	GRM31MR71H684KA88L		
1.0μF(105)	±10%(K)	GRM31CR72A105KA01L	GRM31MR71H105KA88L		
2.2μF(225)	±10%(K)		GRM31CR71H225KA88L	GRM31MR71E225KA93L	GRM31MR71C225KA35L
4.7μF(475)	±10%(K)		GRM31CR71H475KA12L	GRM31CR71E475KA88L	GRM31CR71C475KA01L
10μF(106)	±10%(K)			GRM31CR71E106KA12L*	GRM31CR71C106KAC7L*

长x宽 [mm]		3.2x1.6(31)<1206>		
额定电压 [Vdc]		10(1A)	6.3(0J)	4(0G)
静电容量	公差	品名		
10μF(106)	±10%(K)	GRM31CR71A106KA01L		
22μF(226)	±20%(M)	GRM31CR71A226ME15L*	GRM31CR70J226ME19L*	
47μF(476)	±20%(M)			GRM31CE70G476ME15L*

长x宽 [mm]		3.2x2.5(32)<1210>			
额定电压 [Vdc]		100(2A)	50(1H)	35(YA)	25(1E)
静电容量	公差	品名			
0.68μF(684)	±10%(K)	GRM32CR72A684KA01L	GRM32NR71H684KA01L		
1.0μF(105)	±10%(K)	GRM32CR72A105KA35L			
2.2μF(225)	±10%(K)	GRM32ER72A225KA35L			
4.7μF(475)	±10%(K)		GRM32ER71H475KA88L		
10μF(106)	±10%(K)			GRM32ER7YA106KA12L	GRM32DR71E106KA12L
22μF(226)	±20%(M)				GRM32ER71E226ME15L*

长x宽 [mm]		3.2x2.5(32)<1210>		
额定电压 [Vdc]		16(1C)	10(1A)	6.3(0J)
静电容量	公差	品名		
22μF(226)	±20%(M)	GRM32ER71C226ME18L*		
47μF(476)	±20%(M)		GRM32ER71A476ME15L*	GRM32ER70J476ME20L*

品名代号在()中注明，单位在 []中注明。< >: EIA [英寸] 代号

*: 请参见GRM系列规格和测试方法 (2)。

- | | | | | | | | | | | | | | | | |
|------|----|---|----|---|----|----|-----|---|-----|---|-------|-------|----------|---------|-------|
| (品名) | GR | M | 31 | 9 | R7 | 2A | 153 | K | A01 | L | ①型号 | ②系列 | ③尺寸(长×宽) | ④尺寸(厚度) | ⑤温度特性 |
| | ① | ② | ③ | ④ | ⑤ | ⑥ | ⑦ | ⑧ | ⑨ | ⑩ | ⑥额定电压 | ⑦静电容量 | ⑧静电容量公差 | ⑨个别规格代号 | ⑩包装 |

品名中的包装代号表示标准180mm卷盘。

高介电常数型 X7R(R7)/X7T(D7) 特性 薄型

长x宽 [mm]		1.0x0.5(15)<0402>		
额定电压 [Vdc]		50(1H)	25(1E)	16(1C)
静电容量	公差	品名		
220pF(221)	±10%(K)	GRM15XR71H221KA86D		
330pF(331)	±10%(K)	GRM15XR71H331KA86D		
470pF(471)	±10%(K)	GRM15XR71H471KA86D		
680pF(681)	±10%(K)	GRM15XR71H681KA86D		
1000pF(102)	±10%(K)	GRM15XR71H102KA86D		
1500pF(152)	±10%(K)	GRM15XR71H152KA86D		
2200pF(222)	±10%(K)		GRM15XR71E222KA86D	
3300pF(332)	±10%(K)			GRM15XR71C332KA86D
4700pF(472)	±10%(K)			GRM15XR71C472KA86D
6800pF(682)	±10%(K)			GRM15XR71C682KA86D
10000pF(103)	±10%(K)			GRM15XR71C103KA86D

长x宽 [mm]		1.6x0.8(18)<0603>
额定电压 [Vdc]		10(1A)
静电容量	公差	品名
1.0μF(105)	±10%(K)	GRM185D71A105KE36D*

长x宽 [mm]		2.0x1.25(21)<0805>			
额定电压 [Vdc]		100(2A)	50(1H)	25(1E)	16(1C)
静电容量	公差	品名			
6800pF(682)	±10%(K)	GRM219R72A682KA01D			
33000pF(333)	±10%(K)		GRM219R71H333KA01D		
68000pF(683)	±10%(K)			GRM219R71E683KA01D	
0.22μF(224)	±10%(K)	GRM21AR72A224KAC5L			
0.33μF(334)	±10%(K)	GRM21AR72A334KAC5L	GRM219R71H334KA88D		
0.47μF(474)	±10%(K)			GRM219R71E474KA88D	
0.68μF(684)	±10%(K)			GRM219R71E684KA88D	GRM219R71C684KA01D
1.0μF(105)	±10%(K)			GRM219R71E105KA88D	

品名代号在()中注明，单位在 []中注明。< >: EIA [英寸] 代号
 *: 请参见GRM系列规格和测试方法 (2)。

长x宽 [mm]		3.2x1.6(31)<1206>			
额定电压 [Vdc]		100(2A)	50(1H)	25(1E)	16(1C)
静电容量	公差	品名			
15000pF(153)	±10%(K)	GRM319R72A153KA01L			
22000pF(223)	±10%(K)	GRM31MR72A223KA01L			
33000pF(333)	±10%(K)	GRM31MR72A333KA01L			
47000pF(473)	±10%(K)	GRM31MR72A473KA01L			
68000pF(683)	±10%(K)	GRM31MR72A683KA01L			
0.10μF(104)	±10%(K)	GRM319R72A104KA01D			
0.15μF(154)	±10%(K)	GRM31MR72A154KA01L	GRM31MR71H154KA01L		
0.22μF(224)	±10%(K)	GRM31MR72A224KA01L	GRM31MR71H224KA01L		
0.33μF(334)	±10%(K)		GRM319R71H334KA01D		
0.47μF(474)	±10%(K)	GRM31MR72A474KA35L	GRM31MR71H474KA01L		
0.68μF(684)	±10%(K)	GRM31MR72A684KA35L	GRM31MR71H684KA88L		
1.0μF(105)	±10%(K)		GRM31MR71H105KA88L		
2.2μF(225)	±10%(K)			GRM31MR71E225KA93L	GRM31MR71C225KA35L

长x宽 [mm]		3.2x2.5(32)<1210>	
额定电压 [Vdc]		100(2A)	50(1H)
静电容量	公差	品名	
0.68μF(684)	±10%(K)	GRM32CR72A684KA01L	GRM32NR71H684KA01L
1.0μF(105)	±10%(K)	GRM32CR72A105KA35L	

品名代号在()中注明，单位在 []中注明。< >: EIA [英寸] 代号

高介电常数型 X6S(C8) 特性

长x宽 [mm]	0.6x0.3(03)<0201>		
额定电压 [Vdc]	6.3(0J)	2.5(0E)	
静电容量	公差	品名	
15000pF(153)	±10%(K)	GRM033C80J153KE01D*	
22000pF(223)	±10%(K)	GRM033C80J223KE01D*	
33000pF(333)	±10%(K)	GRM033C80J333KE01D*	
47000pF(473)	±10%(K)	GRM033C80J473KE19D*	
0.10μF(104)	±10%(K)	GRM033C80J104KE84D*	
0.22μF(224)	±10%(K)	GRM033C80E224ME15D*	

长x宽 [mm]	1.0x0.5(15)<0402>		
额定电压 [Vdc]	25(1E)	6.3(0J)	4(0G)
静电容量	公差	品名	
68000pF(683)	±10%(K)	GRM155C81E683KA12D	
0.10μF(104)	±10%(K)	GRM155C81E104KA12D	
0.15μF(154)	±10%(K)	GRM155C80J154KE01D*	GRM155C80G154KE01D*
0.22μF(224)	±10%(K)	GRM155C80J224KE01D*	GRM155C80G224KE01D*
0.33μF(334)	±10%(K)	GRM155C80J334KE01D*	GRM155C80G334KE01D*
0.47μF(474)	±10%(K)	GRM155C80J474KE19D*	GRM155C80G474KE01D*
0.68μF(684)	±10%(K)	GRM155C80G684KE19D*	

长x宽 [mm]	1.6x0.8(18)<0603>			
额定电压 [Vdc]	10(1A)	6.3(0J)	4(0G)	2.5(0E)
静电容量	公差	品名		
1.0μF(105)	±10%(K)	GRM188C80G105MA01D		
2.2μF(225)	±10%(K)	GRM188C81A225KE34D*	GRM188C80J225KE19D*	
4.7μF(475)	±10%(K)	GRM188C80G475KE19D*		
10μF(106)	±20%(M)	GRM188C80E106ME47D*		

长x宽 [mm]	2.0x1.25(21)<0805>			
额定电压 [Vdc]	25(1E)	16(1C)	10(1A)	6.3(0J)
静电容量	公差	品名		
1.0μF(105)	±10%(K)	GRM216C81C105KA12D*		
2.2μF(225)	±10%(K)	GRM219C81C225KA12D*		
4.7μF(475)	±10%(K)	GRM21BC81E475KA12L*	GRM21BC81C475KA88L*	GRM219C81A475KE34D* GRM219C80J475KE19D*
10μF(106)	±10%(K)	GRM21BC81A106KE18L* GRM21BC80J106KE19L* GRM219C80J106KE39D*		

长x宽 [mm]	2.0x1.25(21)<0805>	
额定电压 [Vdc]	4(0G)	
静电容量	公差	品名
10μF(106)	±10%(K)	GRM219C80G106KE19D*
22μF(226)	±20%(M)	GRM21BC80G226ME39L*

品名代号在()中注明，单位在 []中注明。< >: EIA [英寸] 代号

*: 请参见GRM系列规格和测试方法 (2)。

(品名) GR M 03 3 C8 0J 153 K E01 D ①型号 ②系列 ③尺寸(长×宽) ④尺寸(厚度) ⑤温度特性
 ⑥额定电压 ⑦静电容量 ⑧静电容量公差 ⑨个别规格代号 ⑩包装

品名中的包装代号表示标准180mm卷盘。

高介电常数型 X6S(C8)/X6T(D8) 特性

长x宽 [mm]		3.2x1.6(31)<1206>			
额定电压 [Vdc]		25(1E)	16(1C)	10(1A)	6.3(0J)
静电容量	公差	品名			
2.2μF(225)	±10%(K)		GRM316C81C225KA12D*		
4.7μF(475)	±10%(K)		GRM319C81C475KA12D*		
10μF(106)	±10%(K)	GRM31CC81E106KE15L*			
22μF(226)	±20%(M)			GRM31CC81A226ME19L*	GRM31CC80J226ME19L*
47μF(476)	±20%(M)				GRM31CC80J476ME18L*

长x宽 [mm]		3.2x1.6(31)<1206>	
额定电压 [Vdc]		4(0G)	
静电容量	公差	品名	
47μF(476)	±20%(M)	GRM31CC80G476ME19L*	
100μF(107)	±20%(M)	GRM31CD80G107ME39L*	

长x宽 [mm]		3.2x2.5(32)<1210>		
额定电压 [Vdc]		25(1E)	10(1A)	6.3(0J)
静电容量	公差	品名		
10μF(106)	±10%(K)	GRM32DC81E106KA12L		
22μF(226)	±20%(M)	GRM32EC81E226ME15L*		
47μF(476)	±20%(M)		GRM32EC81A476ME19L*	GRM32EC80J476ME64L*

品名代号在()中注明，单位在 []中注明。< >: EIA [英寸] 代号
 *: 请参见GRM系列规格和测试方法 (2)。

高介电常数型 X6S(C8) 特性 薄型

长x宽 [mm]		1.6x0.8(18)<0603>	
额定电压 [Vdc]		10(1A)	6.3(0J)
静电容量	公差	品名	
1.0μF(105)	±10%(K)	GRM185C81A105KE36D*	GRM185C80J105KE26D*

长x宽 [mm]		2.0x1.25(21)<0805>			
额定电压 [Vdc]		16(1C)	10(1A)	6.3(0J)	4(0G)
静电容量	公差	品名			
1.0μF(105)	±10%(K)	GRM216C81C105KA12D*			
2.2μF(225)	±10%(K)	GRM219C81C225KA12D*			
4.7μF(475)	±10%(K)		GRM219C81A475KE34D*	GRM219C80J475KE19D*	
10μF(106)	±10%(K)			GRM219C80J106KE39D*	GRM219C80G106KE19D*

长x宽 [mm]		3.2x1.6(31)<1206>	
额定电压 [Vdc]		16(1C)	
静电容量	公差	品名	
2.2μF(225)	±10%(K)	GRM316C81C225KA12D*	
4.7μF(475)	±10%(K)	GRM319C81C475KA12D*	

长x宽 [mm]		3.2x2.5(32)<1210>	
额定电压 [Vdc]		25(1E)	
静电容量	公差	品名	
10μF(106)	±10%(K)	GRM32DC81E106KA12L	

品名代号在()中注明，单位在 []中注明。< >: EIA [英寸] 代号
 *: 请参见GRM系列规格和测试方法 (2)。

高介电常数型 X5R(R6) 特性

长x宽 [mm]		0.4x0.2(02)<01005>	
额定电压 [Vdc]		10(1A)	6.3(0J)
静电容量	公差	品名	
68pF(680)	±10%(K)	GRM022R61A680KA01L	
100pF(101)	±10%(K)	GRM022R61A101KA01L	
150pF(151)	±10%(K)	GRM022R61A151KA01L	
220pF(221)	±10%(K)	GRM022R61A221KA01L	
330pF(331)	±10%(K)	GRM022R61A331KA01L	
470pF(471)	±10%(K)	GRM022R61A471KA01L	
680pF(681)	±10%(K)		GRM022R60J681KE19L*
1000pF(102)	±10%(K)		GRM022R60J102KE19L*
1500pF(152)	±10%(K)		GRM022R60J152KE19L*
2200pF(222)	±10%(K)		GRM022R60J222KE19L*
3300pF(332)	±10%(K)		GRM022R60J332KE19L*
4700pF(472)	±10%(K)		GRM022R60J472KE19L*
6800pF(682)	±10%(K)		GRM022R60J682KE19L*
10000pF(103)	±10%(K)		GRM022R60J103KE19L*

长x宽 [mm]		0.6x0.3(03)<0201>			
额定电压 [Vdc]		25(1E)	16(1C)	10(1A)	6.3(0J)
静电容量	公差	品名			
100pF(101)	±10%(K)				
150pF(151)	±10%(K)				
220pF(221)	±10%(K)				
330pF(331)	±10%(K)				
470pF(471)	±10%(K)				
680pF(681)	±10%(K)				
1000pF(102)	±10%(K)				
1500pF(152)	±10%(K)				GRM033R61A152KA01D
2200pF(222)	±10%(K)				GRM033R61A222KA01D
3300pF(332)	±10%(K)				GRM033R61A332KA01D
4700pF(472)	±10%(K)				GRM033R61A472KA01D
6800pF(682)	±10%(K)				GRM033R61A682KA01D
10000pF(103)	±10%(K)				GRM033R61A103KA01D
15000pF(153)	±10%(K)				GRM033R60J153KE01D*
22000pF(223)	±10%(K)				GRM033R60J223KE01D*
33000pF(333)	±10%(K)				GRM033R60J333KE01D*
47000pF(473)	±10%(K)				GRM033R60J473KE19D*
0.10μF(104)	±10%(K)				GRM033R61A104KE84D*

品名代号在()中注明，单位在 []中注明。< >: EIA [英寸] 代号

[]: 请参见X7R (R7) 等的特性。

*: 请参见GRM系列规格和测试方法 (2)。

(品名) GR M 02 2 R6 1A 680 K A01 L
 ① ② ③ ④ ⑤ ⑥ ⑦ ⑧ ⑨ ⑩

① 型号

② 系列

③ 尺寸 (长 × 宽)

④ 尺寸 (厚度)

⑤ 温度特性

⑥ 额定电压

⑦ 静电容量

⑧ 静电容量公差

⑨ 个别规格代号

⑩ 包装*

品名中的包装代号表示标准180mm卷盘。

*GRM022: 可适用D代码包装方式。

高介电常数型 X5R(R6) 特性

长x宽 [mm]		1.0x0.5(15)<0402>			
额定电压 [Vdc]		100(2A)	50(1H)	25(1E)	16(1C)
静电容量	公差	品名			
220pF(221)	±10%(K)				
330pF(331)	±10%(K)				
470pF(471)	±10%(K)				
680pF(681)	±10%(K)				
1000pF(102)	±10%(K)		GRM155R61H102KA01D		
1500pF(152)	±10%(K)				
2200pF(222)	±10%(K)		GRM155R61H222KA01D		
3300pF(332)	±10%(K)				
4700pF(472)	±10%(K)		GRM155R61H472KA01D		
6800pF(682)	±10%(K)				
10000pF(103)	±10%(K)				
15000pF(153)	±10%(K)				
22000pF(223)	±10%(K)				GRM155R61C223KA01D
33000pF(333)	±10%(K)				GRM155R61C333KA01D
47000pF(473)	±10%(K)				GRM155R61C473KA01D
68000pF(683)	±10%(K)			GRM155R61E683KA87D	GRM155R61C683KA88D
0.10μF(104)	±10%(K)			GRM155R61E104KA87D	GRM155R61C104KA88D

长x宽 [mm]		1.0x0.5(15)<0402>		
额定电压 [Vdc]		10(1A)	6.3(0J)	4(0G)
静电容量	公差	品名		
33000pF(333)	±10%(K)	GRM155R61A333KA01D		
47000pF(473)	±10%(K)	GRM155R61A473KA01D		
68000pF(683)	±10%(K)	GRM155R61A683KA01D		
0.10μF(104)	±10%(K)	GRM155R61A104KA01D		
0.15μF(154)	±10%(K)	GRM155R61A154KE19D*	GRM155R60J154KE01D*	
0.22μF(224)	±10%(K)	GRM155R61A224KE19D*	GRM155R60J224KE01D*	
0.33μF(334)	±10%(K)	GRM155R61A334KE15D*	GRM155R60J334KE01D*	
0.47μF(474)	±10%(K)	GRM155R61A474KE15D*	GRM155R60J474KE19D*	
0.68μF(684)	±10%(K)	GRM155R61A684KE15D*	GRM155R60J684KE19D*	
1.0μF(105)	±10%(K)	GRM155R61A105KE15D*		
4.7μF(475)	±20%(M)			GRM155R60G475ME87D*

品名代号在()中注明，单位在 []中注明。< >: EIA [英寸] 代号

□: 请参见X7R (R7) 等的特性。

*: 请参见GRM系列规格和测试方法 (2)。

高介电常数型 X5R(R6) 特性

长x宽 [mm]		1.6x0.8(18)<0603>			
额定电压 [Vdc]		100(2A)	50(1H)	25(1E)	16(1C)
静电容量	公差	品名			
220pF(221)	±10%(K)				
330pF(331)	±10%(K)				
470pF(471)	±10%(K)				
680pF(681)	±10%(K)				
1000pF(102)	±10%(K)		GRM188R61H102KA01D		
1500pF(152)	±10%(K)				
2200pF(222)	±10%(K)		GRM188R61H222KA01D		
3300pF(332)	±10%(K)				
4700pF(472)	±10%(K)		GRM188R61H472KA01D		
6800pF(682)	±10%(K)				
10000pF(103)	±10%(K)		GRM188R61H103KA01D		
15000pF(153)	±10%(K)				
22000pF(223)	±10%(K)		GRM188R61H223KA01D		
33000pF(333)	±10%(K)				
47000pF(473)	±10%(K)				
68000pF(683)	±10%(K)				
0.10μF(104)	±10%(K)			GRM188R61E104KA01D	GRM188R61C104KA01D
0.15μF(154)	±10%(K)				
0.22μF(224)	±10%(K)			GRM188R61E224KA88D	GRM188R61C224KA88D
0.33μF(334)	±10%(K)				
0.47μF(474)	±10%(K)			GRM188R61E474KA12D*	GRM188R61C474KA93D*
1.0μF(105)	±10%(K)			GRM188R61E105KA12D*	GRM188R61C105KA93D*
2.2μF(225)	±10%(K)				GRM188R61C225KE15D*

长x宽 [mm]		1.6x0.8(18)<0603>		
额定电压 [Vdc]		10(1A)	6.3(0J)	4(0G)
静电容量	公差	品名		
0.15μF(154)	±10%(K)	GRM188R61A154KA01D		
0.22μF(224)	±10%(K)	GRM188R61A224KA01D		
0.33μF(334)	±10%(K)			
0.47μF(474)	±10%(K)	GRM188R61A474KA61D		
0.68μF(684)	±10%(K)			
2.2μF(225)	±10%(K)	GRM188R61A225KE34D*		
4.7μF(475)	±10%(K)		GRM188R60J475KE19D*	
10μF(106)	±20%(M)		GRM188R60J106ME47D*	GRM188R60G106ME47D*

品名代号在()中注明，单位在 []中注明。<>: EIA [英寸] 代号

[]: 请参见X7R (R7) 等的特性。

*: 请参见GRM系列规格和测试方法 (2)。

(品名) GR M 18 8 R6 1H 102 K A01 D ①型号 ②系列 ③尺寸(长×宽) ④尺寸(厚度) ⑤温度特性
 ⑥额定电压 ⑦静电容量 ⑧静电容量公差 ⑨个别规格代号 ⑩包装

品名中的包装代号表示标准180mm卷盘。

高介电常数型 X5R(R6) 特性

长x宽 [mm]		2.0x1.25(21)<0805>			
额定电压 [Vdc]		100(2A)	50(1H)	25(1E)	16(1C)
静电容量	公差	品名			
6800pF(682)	±10%(K)				
10000pF(103)	±10%(K)				
15000pF(153)	±10%(K)				
22000pF(223)	±10%(K)				
33000pF(333)	±10%(K)				
47000pF(473)	±10%(K)				
68000pF(683)	±10%(K)				
0.10μF(104)	±10%(K)				
0.15μF(154)	±10%(K)				
0.22μF(224)	±10%(K)				
0.33μF(334)	±10%(K)				GRM21BR61C334KA01L
0.47μF(474)	±10%(K)				GRM21BR61C474KA01L
0.68μF(684)	±10%(K)				
1.0μF(105)	±10%(K)			GRM216R61E105KA12D	GRM21BR61C105KA01L
2.2μF(225)	±10%(K)			GRM21BR61E225KA12L	GRM21BR61C225KA88L*
				GRM219R61E225KA12D*	GRM219R61C225KA88D*
4.7μF(475)	±10%(K)			GRM21BR61E475KA12L*	GRM21BR61C475KA88L*
					GRM219R61C475KE15D*
10μF(106)	±10%(K)				GRM21BR61C106KE15L*

长x宽 [mm]		2.0x1.25(21)<0805>		
额定电压 [Vdc]		10(1A)	6.3(0J)	4(0G)
静电容量	公差	品名		
2.2μF(225)	±10%(K)	GRM21BR61A225KA01L		
4.7μF(475)	±10%(K)	GRM219R61A475KE34D*		
10μF(106)	±10%(K)	GRM21BR61A106KE19L*	GRM219R60J106KE19D*	
		GRM219R61A106KE44D*		
22μF(226)	±20%(M)		GRM21BR60J226ME39L*	GRM219R60G226ME66D*

品名代号在()中注明，单位在 []中注明。< >: EIA [英寸] 代号

[]: 请参见X7R (R7) 等的特性。

*: 请参见GRM系列规格和测试方法 (2)。

高介电常数型 X5R(R6) 特性

长x宽 [mm]		3.2x1.6(31)<1206>			
额定电压 [Vdc]		100(2A)	50(1H)	25(1E)	16(1C)
静电容量	公差	品名			
15000pF(153)	±10%(K)				
22000pF(223)	±10%(K)				
33000pF(333)	±10%(K)				
47000pF(473)	±10%(K)				
68000pF(683)	±10%(K)				
0.10μF(104)	±10%(K)				
0.15μF(154)	±10%(K)				
0.22μF(224)	±10%(K)				
0.33μF(334)	±10%(K)				
0.47μF(474)	±10%(K)				
0.68μF(684)	±10%(K)				
1.0μF(105)	±10%(K)				
2.2μF(225)	±10%(K)		GRM31CR61H225KA88L	GRM316R61E225KA12D*	
4.7μF(475)	±10%(K)			GRM31CR61E475KA88L	GRM31CR61C475KA01L
				GRM319R61E475KA12D*	GRM319R61C475KA88D*
10μF(106)	±10%(K)			GRM31CR61E106KA12L*	GRM31CR61C106KA88L
					GRM319R61C106KE15D*
22μF(226)	±20%(M)				GRM31CR61C226ME15L*

长x宽 [mm]		3.2x1.6(31)<1206>		
额定电压 [Vdc]		10(1A)	6.3(0J)	4(0G)
静电容量	公差	品名		
10μF(106)	±10%(K)	GRM319R61A106KE19L*		
22μF(226)	±20%(M)	GRM31CR61A226ME19L*	GRM31CR60J226ME19L*	
47μF(476)	±20%(M)		GRM31CR60J476ME19L*	
100μF(107)	±20%(M)		GRM31CR60J107ME39L*	GRM31CR60G107ME39L*

长x宽 [mm]		3.2x2.5(32)<1210>			
额定电压 [Vdc]		100(2A)	50(1H)	35(YA)	25(1E)
静电容量	公差	品名			
0.68μF(684)	±10%(K)				
1.0μF(105)	±10%(K)				
2.2μF(225)	±10%(K)				
4.7μF(475)	±10%(K)				
10μF(106)	±10%(K)			GRM32ER6YA106KA12L	GRM32DR61E106KA12L
22μF(226)	±20%(M)				GRM32ER61E226ME15L*

长x宽 [mm]		3.2x2.5(32)<1210>		
额定电压 [Vdc]		16(1C)	10(1A)	6.3(0J)
静电容量	公差	品名		
22μF(226)	±20%(M)			
47μF(476)	±20%(M)	GRM32ER61C476ME15L*	GRM32ER61A476ME20L*	

品名代号在()中注明，单位在 []中注明。< >: EIA [英寸] 代号

[]: 请参见X7R (R7) 等的特性。

*: 请参见GRM系列规格和测试方法 (2)。

- | | | | | | | | | | | | | | | | |
|------|----|---|----|---|----|----|-----|---|-----|---|--------|--------|--------------|-----------|--------|
| (品名) | GR | M | 31 | C | R6 | 1H | 225 | K | A88 | L | ① 型号 | ② 系列 | ③ 尺寸 (长 × 宽) | ④ 尺寸 (厚度) | ⑤ 温度特性 |
| | ① | ② | ③ | ④ | ⑤ | ⑥ | ⑦ | ⑧ | ⑨ | ⑩ | ⑥ 额定电压 | ⑦ 静电容量 | ⑧ 静电容量公差 | ⑨ 个别规格代号 | ⑩ 包装 |

品名中的包装代号表示标准180mm卷盘。

高介电常数型 X5R(R6) 特性 薄型

长x宽 [mm]		1.0x0.5(15)<0402>		
额定电压 [Vdc]		16(1C)	25(1E)	16(1C)
静电容量	公差	品名		
220pF(221)	±10%(K)			
330pF(331)	±10%(K)			
470pF(471)	±10%(K)			
680pF(681)	±10%(K)			
1000pF(102)	±10%(K)			
1500pF(152)	±10%(K)			
2200pF(222)	±10%(K)			
3300pF(332)	±10%(K)			
4700pF(472)	±10%(K)			
6800pF(682)	±10%(K)			
10000pF(103)	±10%(K)			

长x宽 [mm]		1.6x0.8(18)<0603>	
额定电压 [Vdc]		16(1C)	10(1A)
静电容量	公差	品名	
1.0μF(105)	±10%(K)	GRM185R61C105KE44D*	GRM185R61A105KE36D*

长x宽 [mm]		2.0x1.25(21)<0805>			
额定电压 [Vdc]		100(2A)	50(1H)	25(1E)	16(1C)
静电容量	公差	品名			
6800pF(682)	±10%(K)				
33000pF(333)	±10%(K)				
68000pF(683)	±10%(K)				
0.22μF(224)	±10%(K)				
0.33μF(334)	±10%(K)				
0.47μF(474)	±10%(K)				
0.68μF(684)	±10%(K)				
1.0μF(105)	±10%(K)			GRM216R61E105KA12D	
2.2μF(225)	±10%(K)			GRM219R61E225KA12D*	GRM219R61C225KA88D*
4.7μF(475)	±10%(K)				GRM219R61C475KE15D*

长x宽 [mm]		2.0x1.25(21)<0805>		
额定电压 [Vdc]		10(1A)	6.3(0J)	4(0G)
静电容量	公差	品名		
4.7μF(475)	±10%(K)	GRM219R61A475KE34D*		
10μF(106)	±10%(K)	GRM219R61A106KE44D*	GRM219R60J106KE19D*	
22μF(226)	±20%(M)			GRM219R60G226ME66D*

品名代号在()中注明，单位在 []中注明。<>: EIA [英寸] 代号
 []: 请参见X7R (R7) 等的特性。

*: 请参见GRM系列规格和测试方法 (2)。

GRM系列规格和测试方法 (1) (注1) 典型检验标准

编号	项目	特性		测试方法																							
		温度补偿型	高介电常数型																								
1	动作温度范围	- 55至 + 125°C (2P/R/S/T, 3P/R/S/T/U, 4P/R/S/T/U: - 25至 + 85°C)	B1, B3, F1: - 25至 + 85°C R1, R7: - 55至 + 125°C R6: - 55至 + 85°C C8: - 55至 + 105°C E4: + 10至 + 85°C F5: - 30至 + 85°C	参考温度: 25°C (2Δ, 3Δ, 4Δ, B1, B3, F1, R1: 20°C)																							
2	额定电压	参见上页		额定电压定义为可向电容器连续施加的最大电压。 当交流电压附加于直流电压时，V ^{P-P} 或V ^{O-P} (以较大者为准) 应维持在额定电压范围内。																							
3	外观	无缺陷或异常		目视检查																							
4	尺寸	在规定尺寸范围内		使用游标卡尺 (对于GRM02尺寸，应使用显微镜)																							
5	介电强度	无缺陷或异常		在端子之间施加*300% (温度补偿型) 或250% (高介电常数型) 额定电压1至5秒时不应观察到任何故障，并且充电/放电电流低于50mA。*500V时为200%																							
6	绝缘电阻	C≤0.047μF: 大于10,000MΩ C>0.047μF: 大于500Ω·F C: 标称静电容量		绝缘电阻应在20/25°C且最大相对湿度为75%条件下，用不超过额定电压的直流电压测量，时间应选在充电开始后2分钟内，并且充电/放电电流低于50mA。																							
7	静电容量	在规定偏差范围内		静电容量/Q/D.F.值应在20/25°C条件下 按表内的频率及电压测量。 <table border="1"> <thead> <tr> <th>特性</th> <th>ΔC</th> <th>ΔC至7U, 1X (大于 1000pF)</th> <th>R6, R7, F5 (C>10μF)</th> <th>E4</th> </tr> </thead> <tbody> <tr> <td>项目</td> <td>至7U, 1X (1000pF 及以下)</td> <td>1 ± 0.1kHz</td> <td>1 ± 0.1kHz</td> <td>120 ± 24Hz</td> <td>1 ± 0.1kHz</td> </tr> <tr> <td>频率</td> <td>1 ± 0.1MHz</td> <td>1 ± 0.2Vrms</td> <td>0.5 ± 0.1Vrms</td> <td>0.5 ± 0.05Vrms</td> <td></td> </tr> <tr> <td>电压</td> <td>0.5至5Vrms</td> <td></td> <td></td> <td></td> <td></td> </tr> </tbody> </table>	特性	ΔC	ΔC至7U, 1X (大于 1000pF)	R6, R7, F5 (C>10μF)	E4	项目	至7U, 1X (1000pF 及以下)	1 ± 0.1kHz	1 ± 0.1kHz	120 ± 24Hz	1 ± 0.1kHz	频率	1 ± 0.1MHz	1 ± 0.2Vrms	0.5 ± 0.1Vrms	0.5 ± 0.05Vrms		电压	0.5至5Vrms				
特性	ΔC	ΔC至7U, 1X (大于 1000pF)	R6, R7, F5 (C>10μF)		E4																						
项目	至7U, 1X (1000pF 及以下)	1 ± 0.1kHz	1 ± 0.1kHz	120 ± 24Hz	1 ± 0.1kHz																						
频率	1 ± 0.1MHz	1 ± 0.2Vrms	0.5 ± 0.1Vrms	0.5 ± 0.05Vrms																							
电压	0.5至5Vrms																										
8	Q/散逸因数 (D.F.)	30pF及以上: Q≥1000 30pF及以下: Q≥400 + 20C C: 标称静电容量 (pF)	[R6, R7, C8] W.V.: 100V : 最大0.025 (C<0.068μF) : 最大0.05 (C≥0.068μF) W.V.: 50/35/25V: : 最大0.025* *GRM32D R7/R6/C8 1E106: 最大0.035 W.V.: 16/10V: 最大0.035 W.V.: 6.3/4V : 最大0.05 (C<3.3μF) : 最大0.1 (C≥3.3μF) [E4] W.V.: 最小25V: 最大0.025 [F1, F5] W.V.: 最小25V : 最大0.05 (C<0.1μF) : 最大0.09 (C≥0.1μF) W.V.: 16/10V: 最大0.125 W.V.: 6.3V: 最大0.15																								

接下页。 ↗

1 GRM系列规格和测试方法 (1) (注1) 典型检验标准

(注1) 下列规格和测试方法只表示典型检验标准。
 请参照个别规格 (村田的产品规格书或产品承认书)。
 当品名表中未附有“*”时，请参见GRM系列规格和测试方法 (1)。
 当品名表中附有“*”时，请参见GRM系列规格和测试方法 (2)。

☐ 接上页。

编号	项目	特性		测试方法																																							
		温度补偿型	高介电常数型																																								
9	静电容量 温度特性	无偏置	在规定偏差范围内 (表A-1) B1, B3: 在 ±10% 范围内 (-25至+85°C) R1, R7: 在 ±15% 范围内 (-55至+125°C) R6: 在 ±15% 范围内 (-55至+85°C) E4: 在 +22/-56% 范围内 (+10至+85°C) F1: 在 +30/-80% 范围内 (-25至+85°C) F5: 在 +22/-82% 范围内 (-30至+85°C) C8: 在 ±22% 范围内 (-55至+105°C)	静电容量变化应在进入规定的各温度阶段5分钟后测量。 (1) 温度补偿型 温度系数使用在第3阶段中测得的静电容量作为参考来确定。 在依次通过第1阶段至第5阶段的温度时，(5C: +25至+125°C / ΔC: +20至+125°C: 其他温度系数: +25至+85°C / +20至+85°C) 静电容量应在表A-1规定的温度系数和静电容量变化偏差范围内。 静电容量漂移是将在第1、3及5阶段测得的最大和最小值之间的差除以第3阶段的静电容量值计算而得。 <table border="1"> <thead> <tr> <th>阶段</th> <th>温度 (°C)</th> </tr> </thead> <tbody> <tr> <td>1</td> <td>参考温度 ± 2</td> </tr> <tr> <td>2</td> <td>- 55 ± 3 (对于ΔC至7U/R6/R7/C8) - 30 ± 3 (对于F5), 10 ± 3 (对于E4) - 25 ± 3 (对于其他TC)</td> </tr> <tr> <td>3</td> <td>参考温度 ± 2</td> </tr> <tr> <td>4</td> <td>125 ± 3 (对于ΔC/R7), 105 ± 3 (对于C8) 85 ± 3 (对于其他TC)</td> </tr> <tr> <td>5</td> <td>参考温度 ± 2</td> </tr> </tbody> </table>	阶段	温度 (°C)	1	参考温度 ± 2	2	- 55 ± 3 (对于ΔC至7U/R6/R7/C8) - 30 ± 3 (对于F5), 10 ± 3 (对于E4) - 25 ± 3 (对于其他TC)	3	参考温度 ± 2	4	125 ± 3 (对于ΔC/R7), 105 ± 3 (对于C8) 85 ± 3 (对于其他TC)	5	参考温度 ± 2																											
		阶段	温度 (°C)																																								
1	参考温度 ± 2																																										
2	- 55 ± 3 (对于ΔC至7U/R6/R7/C8) - 30 ± 3 (对于F5), 10 ± 3 (对于E4) - 25 ± 3 (对于其他TC)																																										
3	参考温度 ± 2																																										
4	125 ± 3 (对于ΔC/R7), 105 ± 3 (对于C8) 85 ± 3 (对于其他TC)																																										
5	参考温度 ± 2																																										
50% 额定电压	B1: 在 +10/-30% 范围内 R1: 在 +15/-40% 范围内 F1: 在 +30/-95% 范围内																																										
	静电容量 漂移	在 ±0.2% 或 ±0.05pF (以较大者为基准) 范围内 *不适用1X/25V	*高介电常数型的初次测量 在 150 + 0 / - 10°C 条件下进行1 小时热处理，然后在常温下放 置 24 ± 2 小时。 之后进行初次测量	(2) 高介电常数型 表中所示的温度范围内静电容量的变化较于参考温度时容量的变 化都应在规定范围内。* 如果要施加电压，静电容量变化应再过1分钟后测量，以使所加 电压在各温度阶段得到平衡。 <table border="1"> <thead> <tr> <th>阶段</th> <th>温度 (°C)</th> <th>外加电压 (V)</th> </tr> </thead> <tbody> <tr> <td>1</td> <td>参考温度 ± 2</td> <td rowspan="3">无偏置</td> </tr> <tr> <td>2</td> <td>- 55 ± 3 (对于C8, R1, R7, R6) - 25 ± 3 (对于B1, B3, F1) - 30 ± 3 (对于F5)/10 ± 3 (对于E4)</td> </tr> <tr> <td>3</td> <td>参考温度 ± 2</td> </tr> <tr> <td>4</td> <td>125 ± 3 (对于R1, R7)/ 85 ± 3 (对于B1, B3, R6 F1, F5, E4)/105 ± 3 (对于C8)</td> <td rowspan="5">50% 额定电压</td> </tr> <tr> <td>5</td> <td>参考温度 ± 2</td> </tr> <tr> <td>6</td> <td>- 55 ± 3 (对于R1)/ - 25 ± 3 (对于B1, F1)</td> </tr> <tr> <td>7</td> <td>参考温度 ± 2</td> </tr> <tr> <td>8</td> <td>125 ± 3 (对于R1)/ 85 ± 3 (对于B1, F1)</td> </tr> </tbody> </table>	阶段	温度 (°C)	外加电压 (V)	1	参考温度 ± 2	无偏置	2	- 55 ± 3 (对于C8, R1, R7, R6) - 25 ± 3 (对于B1, B3, F1) - 30 ± 3 (对于F5)/10 ± 3 (对于E4)	3	参考温度 ± 2	4	125 ± 3 (对于R1, R7)/ 85 ± 3 (对于B1, B3, R6 F1, F5, E4)/105 ± 3 (对于C8)	50% 额定电压	5	参考温度 ± 2	6	- 55 ± 3 (对于R1)/ - 25 ± 3 (对于B1, F1)	7	参考温度 ± 2	8	125 ± 3 (对于R1)/ 85 ± 3 (对于B1, F1)																		
阶段	温度 (°C)	外加电压 (V)																																									
1	参考温度 ± 2	无偏置																																									
2	- 55 ± 3 (对于C8, R1, R7, R6) - 25 ± 3 (对于B1, B3, F1) - 30 ± 3 (对于F5)/10 ± 3 (对于E4)																																										
3	参考温度 ± 2																																										
4	125 ± 3 (对于R1, R7)/ 85 ± 3 (对于B1, B3, R6 F1, F5, E4)/105 ± 3 (对于C8)	50% 额定电压																																									
5	参考温度 ± 2																																										
6	- 55 ± 3 (对于R1)/ - 25 ± 3 (对于B1, F1)																																										
7	参考温度 ± 2																																										
8	125 ± 3 (对于R1)/ 85 ± 3 (对于B1, F1)																																										
10	端子结合强度	不应出现端子脱落或其它缺陷。 	使用共晶锡将电容器焊接在图1a中所示的测试夹具 (玻璃环氧树脂 脂板) 上。然后平行于测试夹具施加 10N* 的力 10 ± 1 秒。 焊接应利用烙铁或使用回流焊接方式进行，而且应谨慎作业， 以使焊接均匀且不会由于热冲击产生缺陷。 *1N (GRM02), 2N (GRM03), 5N (GRM15, GRM18) (in mm) <table border="1"> <thead> <tr> <th>型号</th> <th>a</th> <th>b</th> <th>c</th> </tr> </thead> <tbody> <tr> <td>GRM02</td> <td>0.2</td> <td>0.56</td> <td>0.23</td> </tr> <tr> <td>GRM03</td> <td>0.3</td> <td>0.9</td> <td>0.3</td> </tr> <tr> <td>GRM15</td> <td>0.4</td> <td>1.5</td> <td>0.5</td> </tr> <tr> <td>GRM18</td> <td>1.0</td> <td>3.0</td> <td>1.2</td> </tr> <tr> <td>GRM21</td> <td>1.2</td> <td>4.0</td> <td>1.65</td> </tr> <tr> <td>GRM31</td> <td>2.2</td> <td>5.0</td> <td>2.0</td> </tr> <tr> <td>GRM32</td> <td>2.2</td> <td>5.0</td> <td>2.9</td> </tr> <tr> <td>GRM43</td> <td>3.5</td> <td>7.0</td> <td>3.7</td> </tr> <tr> <td>GRM55</td> <td>4.5</td> <td>8.0</td> <td>5.6</td> </tr> </tbody> </table>	型号	a	b	c	GRM02	0.2	0.56	0.23	GRM03	0.3	0.9	0.3	GRM15	0.4	1.5	0.5	GRM18	1.0	3.0	1.2	GRM21	1.2	4.0	1.65	GRM31	2.2	5.0	2.0	GRM32	2.2	5.0	2.9	GRM43	3.5	7.0	3.7	GRM55	4.5	8.0	5.6
型号	a	b	c																																								
GRM02	0.2	0.56	0.23																																								
GRM03	0.3	0.9	0.3																																								
GRM15	0.4	1.5	0.5																																								
GRM18	1.0	3.0	1.2																																								
GRM21	1.2	4.0	1.65																																								
GRM31	2.2	5.0	2.0																																								
GRM32	2.2	5.0	2.9																																								
GRM43	3.5	7.0	3.7																																								
GRM55	4.5	8.0	5.6																																								

☐ 接下页。

GRM系列规格和测试方法 (1) (注1) 典型检验标准

(注1) 下列规格和测试方法只表示典型检验标准。
 请参照个别规格 (村田的产品规格书或产品承认书)。
 当品名表中未附有“*”时，请参见GRM系列规格和测试方法 (1)。
 当品名表中附有“*”时，请参见GRM系列规格和测试方法 (2)。

接上页。

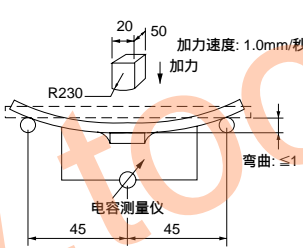
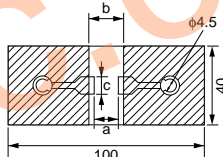
编号	项目	特性		测试方法																																								
		温度补偿型	高介电常数型																																									
11	外观	无缺陷或异常		按照与 (10) 相同的方法和条件，将电容器焊接在测试夹具 (玻璃环氧树脂板) 上。 电容器应进行简谐运动，其总幅值为1.5mm，频率在近似10至55Hz之间均匀变化。频率范围 (从10至55Hz再返回10Hz) 应在约1分钟内完成。振动应在3个相互垂直方向各进行2小时 (总计6小时)。																																								
	静电容量	在规定偏差范围内																																										
11	振荡电阻	[B1, B3, R6, R7, C8] W.V.: 100V : 最大0.025 (C<0.068μF) : 最大0.05 (C≥0.068μF) W.V.: 50/35/25V: : 最大0.025* *GRM32D R7/R6/C8 1E106: 最大0.035 W.V.: 最大16/10V: 0.035 W.V.: 6.3/4V : 最大0.05 (C<3.3μF) : 最大0.1 (C≥3.3μF)		按照与 (10) 相同的方法和条件，将电容器焊接在测试夹具 (玻璃环氧树脂板) 上。 电容器应进行简谐运动，其总幅值为1.5mm，频率在近似10至55Hz之间均匀变化。频率范围 (从10至55Hz再返回10Hz) 应在约1分钟内完成。振动应在3个相互垂直方向各进行2小时 (总计6小时)。 [E4] W.V.: 最小25V: 最大0.025 [F1, F5] W.V.: 最小25V : 最大0.05 (C<0.1μF) : 最大0.09 (C≥0.1μF) W.V.: 16/10V: 最大0.125 W.V.: 6.3V: 最大0.15																																								
	Q/D.F.	30pF及以上: $Q \geq 1000$ 30pF及以上: $Q \geq 400 + 20C$ C: 标称静电容量 (pF)																																										
12	外观	无明显缺陷		使用共晶锡将电容器焊接在图2a中所示的测试夹具 (玻璃环氧树脂板) 上。然后在图3a所示的方向加力5±1秒钟。焊接应使用回流焊接方法进行，而且应谨慎作业，以使焊接均匀且不会由于热冲击产生缺陷。																																								
	静电容量变化	在 ±5% 或 ±0.5pF (以较大者为准) 范围内	在 ±10% 范围内																																									
12	弯曲强度			 <p>图2a</p> <p>t: 1.6mm (GRM02/03/15: t: 0.8mm)</p> <table border="1"> <thead> <tr> <th>型号</th> <th>a</th> <th>b</th> <th>c</th> </tr> </thead> <tbody> <tr> <td>GRM02</td> <td>0.2</td> <td>0.56</td> <td>0.23</td> </tr> <tr> <td>GRM03</td> <td>0.3</td> <td>0.9</td> <td>0.3</td> </tr> <tr> <td>GRM15</td> <td>0.4</td> <td>1.5</td> <td>0.5</td> </tr> <tr> <td>GRM18</td> <td>1.0</td> <td>3.0</td> <td>1.2</td> </tr> <tr> <td>GRM21</td> <td>1.2</td> <td>4.0</td> <td>1.65</td> </tr> <tr> <td>GRM31</td> <td>2.2</td> <td>5.0</td> <td>2.0</td> </tr> <tr> <td>GRM32</td> <td>2.2</td> <td>5.0</td> <td>2.9</td> </tr> <tr> <td>GRM43</td> <td>3.5</td> <td>7.0</td> <td>3.7</td> </tr> <tr> <td>GRM55</td> <td>4.5</td> <td>8.0</td> <td>5.6</td> </tr> </tbody> </table> <p>(in mm)</p>	型号	a	b	c	GRM02	0.2	0.56	0.23	GRM03	0.3	0.9	0.3	GRM15	0.4	1.5	0.5	GRM18	1.0	3.0	1.2	GRM21	1.2	4.0	1.65	GRM31	2.2	5.0	2.0	GRM32	2.2	5.0	2.9	GRM43	3.5	7.0	3.7	GRM55	4.5	8.0	5.6
	型号	a	b		c																																							
GRM02	0.2	0.56	0.23																																									
GRM03	0.3	0.9	0.3																																									
GRM15	0.4	1.5	0.5																																									
GRM18	1.0	3.0	1.2																																									
GRM21	1.2	4.0	1.65																																									
GRM31	2.2	5.0	2.0																																									
GRM32	2.2	5.0	2.9																																									
GRM43	3.5	7.0	3.7																																									
GRM55	4.5	8.0	5.6																																									
13	端子可焊性	75%端子需均匀且连续焊接。		将电容器浸泡在乙醇 (JIS-K-8101) 和松香 (JIS-K-5902) (松香占25%的重量) 溶液中。 在80至120°C范围内预热10至30秒。 预热后，再浸泡在230 ± 5°C的共晶锡溶液2 ± 0.5秒或在245 ± 5°C的Sn-3.0Ag-0.5Cu无铅焊锡溶液2 ± 0.5秒。																																								

接下页。

1 GRM系列规格和测试方法 (1) (注1) 典型检验标准

(注1) 下列规格和测试方法只表示典型检验标准。
 请参照个别规格 (村田的产品规格书或产品承认书)。
 当品名表中未附有“*”时，请参见GRM系列规格和测试方法 (1)。
 当品名表中附有“*”时，请参见GRM系列规格和测试方法 (2)。

接上页。

编号	项目	特性		测试方法	
		温度补偿型	高介电常数型		
14	耐焊热性	测量及观测到的特性应满足下表规定。			在120°C至150°C范围内预热电容器1分钟。 将电容器浸泡在270 ± 5°C的共晶锡溶液或Sn-3.0Ag-0.5Cu无铅焊锡溶液10 ± 0.5秒。在常温下放置24 ± 2小时，然后进行测量。 •高介电常数型的初次测量 在150 + 0/ - 10°C条件下进行1小时热处理，再在常温下放置24 + 4小时。之后进行初次测量。 •预热GRM32/43/55
		外观	无缺陷或异常		
		静电容变化	在 ± 2.5%或±0.25pF (以较大者为准) 范围内	B1, B3, R1, R6, R7, C8 : 在 ± 7.5%范围内 F1, F5, E4: 在 ± 20%范围内	
		Q/D.F.	30pF及以上: Q ≥ 1000 30pF及以下: Q ≥ 400 + 20C C: 标称静容量 (pF)	[B1, B3, R6, R7, C8] W.V.: 100V : 最大0.025 (C < 0.068μF) : 最大0.05 (C ≥ 0.068μF) W.V.: 50/35/25V: : 最大0.025* *GRM32D R7/R6/C8 1E106: 最大0.035 W.V.: 16/10V: 最大0.035 W.V.: 6.3/4V : 最大0.05 (C < 3.3μF) : 最大0.1 (C ≥ 3.3μF) [E4] W.V.: 最小25V: 最大0.025 [F1, F5] W.V.: 最小25V : 最大0.05 (C < 0.1μF) : 最大0.09 (C ≥ 0.1μF) W.V.: 16/10V: 最大0.125 W.V.: 6.3V: 最大0.15	
		绝缘电阻	大于10,000MΩ或500Ω · F (以较小者为准)		
		介电强度	无缺陷		
15	温度周期	测量及观测到的特性应满足下表规定。			按照与 (10) 相同的方法和条件，将电容器固定在支撑夹具上。 按照下表中列出的4种热处理方法执行5个周期。 在常温下放置24 ± 2小时，然后进行测量。 •高介电常数型的初次测量 在150 + 0/ - 10°C条件下进行1小时热处理，再在常温下放置24 ± 2小时。之后进行初次测量。
		外观	无缺陷或异常		
		静电容变化	在 ± 2.5%或 ± 0.25pF (以较大者为准) 范围内	B1, B3, R1, R6, R7, C8 : 在 ± 7.5%范围内 F1, F5, E4: 在 ± 20%范围内	
		Q/D.F.	30pF及以上: Q ≥ 1000 30pF及以下: Q ≥ 400 + 20C C: 标称静容量 (pF)	[B1, B3, R6, R7, C8] W.V.: 100V : 最大0.025 (C < 0.068μF) : 最大0.05 (C ≥ 0.068μF) W.V.: 50/35/25V: : 最大0.025* *GRM32D R7/R6/C8 1E106: 最大0.035 W.V.: 16/10V: 最大0.035 W.V.: 6.3/4V : 最大0.05 (C < 3.3μF) : 最大0.1 (C ≥ 3.3μF) [E4] W.V.: 最小25V: 最大0.05 [F1, F5] W.V.: 最小25V : 最大0.05 (C < 0.1μF) : 最大0.09 (C ≥ 0.1μF) W.V.: 16/10V: 最大0.125 W.V.: 6.3V: 最大0.15	
		绝缘电阻	大于10,000MΩ或500Ω · F (以较小者为准)		
		介电强度	无缺陷		

阶段	温度	时间
1	100至120°C	1分钟
2	170至200°C	1分钟

阶段	1	2	3	4
温度 (°C)	最低 动作温度 + 0/ - 3	常温	最高 动作温度 + 3/ - 0	常温
时间 (分钟)	30 ± 3	2至3	30 ± 3	2至3

接下页。

GRM系列规格和测试方法 (1) (注1) 典型检验标准

(注1) 下列规格和测试方法只表示典型检验标准。
 请参照个别规格 (村田的产品规格书或产品承认书)。
 当品名表中未附有“*”时，请参见GRM系列规格和测试方法 (1)。
 当品名表中附有“*”时，请参见GRM系列规格和测试方法 (2)。

接上页。

编号	项目	特性		测试方法
		温度补偿型	高介电常数型	
16		测量及观测到的特性应满足下表规定。		将电容器在40 ± 2°C及90至95%湿度条件下放置500 ± 12小时。撤到常温下放置24 ± 2小时，然后进行测量。
	外观	无缺陷或异常		
	静电容量变化	在 ± 5%或 ± 0.5pF (以较大者为准) 范围内	B1, B3, R1, R6, R7, C8 : 在 ± 12.5%范围内 F1, F5, E4: 在 ± 30%范围内	
	Q/D.F.	30pF及以上: Q ≥ 350 10pF及以上 30pF及以下: Q ≥ 275 + 2.5C 10pF及以下: Q ≥ 200 + 10C C: 标称静电容量 (pF)	[R6, R7, C8] W.V.: 100V : 最大0.05 (C < 0.068μF) : 最大0.075 (C ≥ 0.068μF) W.V.: 50/35/25/16/10V : 最大0.05 W.V.: 6.3/4V : 最大0.075 (C < 3.3μF) : 最大0.125 (C ≥ 3.3μF) [E4] W.V.: 最小25V: 最大0.05 [F1, F5] W.V.: 最小25V : 最大0.075 (C < 0.1μF) : 最大0.125 (C ≥ 0.1μF) W.V.: 16/10V: 最大0.15 W.V.: 6.3V: 最大0.2	
	绝缘电阻	大于1,000MΩ或50Ω · F (以较小者为准)		
17		测量及观测到的特性应满足下表规定。		在40 ± 2°C及90至95%湿度条件下施加额定电压500 ± 12小时。撤到常温下放置24 ± 2小时，然后进行测量。 充电/放电电流小于50mA。 *F1、F5/最大10V的初次测量 在40 ± 2°C条件下施加直流额定电压1小时。撤到常温下放置24 ± 2小时。之后进行初次测量。
	外观	无缺陷或异常		
	静电容量变化	在 ± 7.5%或 ± 0.75pF (以较大者为准) 范围内	B1, B3, R1, R6, R7, C8 : 在 ± 12.5%范围内 F1, F5, E4: 在 ± 30%范围内 [W.V.: 最大10V] F1, F5: 在 + 30/ - 40%范围内	
	Q/D.F.	30pF及以上: Q ≥ 200 30pF及以下: Q ≥ 100 + 10C/3 C: 标称静电容量 (pF)	[B1, B3, R6, R7, C8] W.V.: 100V : 最大0.05 (C < 0.068μF) : 最大0.075 (C ≥ 0.068μF) W.V.: 50/35/25/16/10V : 最大0.05 W.V.: 6.3/4V : 最大0.075 (C < 3.3μF) : 最大0.125 (C ≥ 3.3μF) [E4] W.V.: 最小25V: 最大0.05 [F1, F5] W.V.: 最小25V : 最大0.075 (C < 0.1μF) : 最大0.125 (C ≥ 0.1μF) W.V.: 16/10V: 最大0.15 W.V.: 6.3V: 最大0.2	
	绝缘电阻	大于500MΩ或25Ω · F (以较小者为准)		

接下页。

1 GRM系列规格和测试方法 (1) (注1) 典型检验标准

(注1) 下列规格和测试方法只表示典型检验标准。
 请参照个别规格 (村田的产品规格书或产品承认书)。
 当品名表中未附有“*”时，请参见GRM系列规格和测试方法 (1)。
 当品名表中附有“*”时，请参见GRM系列规格和测试方法 (2)。

接上页。

编号	项目	特性		测试方法	
		温度补偿型	高介电常数型		
18	高温负荷	测量及观测到的特性应满足下表规定。			在最高工作温度 ± 3°C 条件下施加 200% * 额定电压 1000 ± 12 小时。 再在常温下放置 24 ± 2 小时，然后进行测量。 充电/放电电流低于 50mA。 *高介电常数型的初次测量 在最高工作温度 ± 3°C 条件下施加 200% 额定电压 * 1 小时。撤到 常温下放置 24 ± 2 小时。 之后进行初次测量。 *GRM155C81E 683/104, GRM21BR71H105, GRM21BR72A474, GRM21BR71C225, GRM31CR71H475, GRM32E R6/R7 YA106, GRM32D R7/R6/C8 1E106: 150% 额定电压
		外观	无缺陷或异常		
		静电容量变化	在 ± 3% 或 ± 0.3pF (以较大者为准) 范围内	B1, B3, R1, R6, R7, C8 : 在 ± 12.5% 范围内 F1, F5, E4: 在 ± 30% 范围内 [最大 10V 及 C ≥ 1.0μF 除外] F1, F5: 在 + 30/ - 40% 范围内 [最大 10V 及 C ≥ 1.0μF]	
		Q/D.F.	30pF 及以上: Q ≥ 350 10pF 及以上 30pF 及以下: Q ≥ 275 + 2.5C 10pF 及以下: Q ≥ 200 + 10C C: 标称静电容量 (pF)	[B1, B3, R6, R7, C8] W.V.: 100V : 最大 0.05 (C < 0.068μF) : 最大 0.075 (C ≥ 0.068μF) W.V.: 50/35/25/16/10V : 最大 0.05 W.V.: 6.3/4V : 最大 0.075 (C < 3.3μF) : 最大 0.125 (C ≥ 3.3μF) [E4] W.V.: 最小 25V: 最大 0.05 [F1, F5] W.V.: 最小 25V : 最大 0.075 (C < 0.1μF) : 最大 0.125 (C ≥ 0.1μF) W.V.: 16/10V: 最大 0.15 W.V.: 6.3V: 最大 0.2	
	绝缘电阻	大于 1,000MΩ 或 50Ω · F (以较小者为准)			

表A-1
(1)

特性代号	温度系数 (ppm/°C)*1	与25°C时静电容量值相比的变化 (%)					
		- 55		- 30		- 10	
		最大	最小	最大	最小	最大	最小
5C	0 ± 30	0.58	-0.24	0.40	-0.17	0.25	-0.11
6C	0 ± 60	0.87	-0.48	0.59	-0.33	0.38	-0.21
6P	-150 ± 60	2.33	0.72	1.61	0.50	1.02	0.32
6R	-220 ± 60	3.02	1.28	2.08	0.88	1.32	0.56
6S	-330 ± 60	4.09	2.16	2.81	1.49	1.79	0.95
6T	-470 ± 60	5.46	3.28	3.75	2.26	2.39	1.44
7U	-750 ± 120	8.78	5.04	6.04	3.47	3.84	2.21
1X	+350至-1000	-	-	-	-	-	-

*1: 标称值表示在25°C至125°C (对于ΔC)/85°C (对于其它TC) 范围内的温度系数。

(2)

特性代号	温度系数 (ppm/°C)*2	与20°C时静电容量值相比的变化 (%)					
		- 55		- 25		- 10	
		最大	最小	最大	最小	最大	最小
2C	0 ± 60	0.82	-0.45	0.49	-0.27	0.33	-0.18
3C	0 ± 120	1.37	-0.90	0.82	-0.54	0.55	-0.36
4C	0 ± 250	2.56	-1.88	1.54	-1.13	1.02	-0.75
2P	-150 ± 60	-	-	1.32	0.41	0.88	0.27
3P	-150 ± 120	-	-	1.65	0.14	1.10	0.09
4P	-150 ± 250	-	-	2.36	-0.45	1.57	-0.30
2R	-220 ± 60	-	-	1.70	0.72	1.13	0.48
3R	-220 ± 120	-	-	2.03	0.45	1.35	0.30
4R	-220 ± 250	-	-	2.74	-0.14	1.83	-0.09
2S	-330 ± 60	-	-	2.30	1.22	1.54	0.81
3S	-330 ± 120	-	-	2.63	0.95	1.76	0.63
4S	-330 ± 250	-	-	3.35	0.36	2.23	0.24
2T	-470 ± 60	-	-	3.07	1.85	2.05	1.23
3T	-470 ± 120	-	-	3.40	1.58	2.27	1.05
4T	-470 ± 250	-	-	4.12	0.99	2.74	0.66
3U	-750 ± 120	-	-	4.94	2.84	3.29	1.89
4U	-750 ± 250	-	-	5.65	2.25	3.77	1.50

*2: 标称值表示在20°C至125°C (对于ΔC)/85°C (对于其它TC) 范围内的温度系数。



GRM系列规格和测试方法 (2) (注1) 典型检验标准

1

(注1) 下列规格和测试方法只表示典型检验标准。
 请参照个别规格 (村田的产品规格书或产品承认书)。
 当品名表中未附有“*”时，请参见GRM系列规格和测试方法 (1)。
 当品名表中附有“*”时，请参见GRM系列规格和测试方法 (2)。

编号	项目	特性	测试方法																																																											
1	动作温度范围	B1, B3, F1: - 25至 + 85°C R1, R7, C7, D7, E7: - 55至 + 125°C C6, R6: - 55至 + 85°C F5: - 30至 + 85°C C8, D8: - 55至 + 105°C,	参考温度: 25°C (B1, B3, R1, F1: 20°C)																																																											
2	额定电压	参见上页	额定电压定义为可向电容器连续施加的最大电压。 当交流电压附加于直流电压时，V ^{P-P} 或V ^{O-P} (以较大者为准) 应维持在额定电压范围内。																																																											
3	外观	无缺陷或异常	目视检查																																																											
4	尺寸	在规定尺寸范围内	使用游标卡尺 (对于GRM02尺寸，应使用显微镜)																																																											
5	介电强度	无缺陷或异常	在端子间施加250%额定电压1至5秒时不应观察到任何故障，并且充电/放电电流低于50mA。																																																											
6	绝缘电阻	大于50Ω · F	绝缘电阻应在参考温度且最大相对湿度为75%条件下用不超过额定电压的直流电压测量，时间应在充电开始后1分钟内，并且充电/放电电流低于50mA。																																																											
7	静电容量	在规定偏差范围内 *表1 <table border="1"> <thead> <tr> <th>GRM155</th> <th>B3/R6</th> <th>1A</th> <th>124至105</th> </tr> </thead> <tbody> <tr> <td>GRM185</td> <td>B3/R6</td> <td>1C/1A</td> <td>105</td> </tr> <tr> <td>GRM185</td> <td>C8/D7</td> <td>1A</td> <td>105</td> </tr> <tr> <td>GRM188</td> <td>B3/R6</td> <td>1C/1A</td> <td>225</td> </tr> <tr> <td>GRM188</td> <td>R7/C8</td> <td>1A</td> <td>225</td> </tr> <tr> <td>GRM188</td> <td>B3/R6</td> <td>1A</td> <td>335</td> </tr> <tr> <td>GRM219</td> <td>B3/R6</td> <td>1C/1A</td> <td>475, 106</td> </tr> <tr> <td>GRM219</td> <td>C8</td> <td>1A</td> <td>475</td> </tr> <tr> <td>GRM21B</td> <td>B3/R6</td> <td>1C/1A</td> <td>106</td> </tr> <tr> <td>GRM21B</td> <td>R7/C8</td> <td>1A</td> <td>106</td> </tr> <tr> <td>GRM319</td> <td>B3/R6</td> <td>1C/1A</td> <td>106</td> </tr> </tbody> </table>	GRM155	B3/R6	1A	124至105	GRM185	B3/R6	1C/1A	105	GRM185	C8/D7	1A	105	GRM188	B3/R6	1C/1A	225	GRM188	R7/C8	1A	225	GRM188	B3/R6	1A	335	GRM219	B3/R6	1C/1A	475, 106	GRM219	C8	1A	475	GRM21B	B3/R6	1C/1A	106	GRM21B	R7/C8	1A	106	GRM319	B3/R6	1C/1A	106	静电容量/D.F.值应在参考温度条件下，按表内的测量频率及电压测量。 <table border="1"> <thead> <tr> <th>标称静电容量</th> <th>测量频率</th> <th>测量电压</th> </tr> </thead> <tbody> <tr> <td>C≤10μF (最小10V)*</td> <td>1 ± 0.1kHz</td> <td>1.0 ± 0.2Vrms</td> </tr> <tr> <td>C≤10μF (最大6.3V)</td> <td>1 ± 0.1kHz</td> <td>0.5 ± 0.1Vrms</td> </tr> <tr> <td>C>10μF</td> <td>120 ± 24Hz</td> <td>0.5 ± 0.1Vrms</td> </tr> <tr> <td>*表1的项目</td> <td>1 ± 0.1kHz</td> <td>0.5 ± 0.1Vrms</td> </tr> </tbody> </table> GRM188C80E106: 在150 ± 0 / - 10°C条件下进行1小时热处理，然后在常温下放置24 ± 2小时。	标称静电容量	测量频率	测量电压	C≤10μF (最小10V)*	1 ± 0.1kHz	1.0 ± 0.2Vrms	C≤10μF (最大6.3V)	1 ± 0.1kHz	0.5 ± 0.1Vrms	C>10μF	120 ± 24Hz	0.5 ± 0.1Vrms	*表1的项目	1 ± 0.1kHz	0.5 ± 0.1Vrms
GRM155	B3/R6	1A	124至105																																																											
GRM185	B3/R6	1C/1A	105																																																											
GRM185	C8/D7	1A	105																																																											
GRM188	B3/R6	1C/1A	225																																																											
GRM188	R7/C8	1A	225																																																											
GRM188	B3/R6	1A	335																																																											
GRM219	B3/R6	1C/1A	475, 106																																																											
GRM219	C8	1A	475																																																											
GRM21B	B3/R6	1C/1A	106																																																											
GRM21B	R7/C8	1A	106																																																											
GRM319	B3/R6	1C/1A	106																																																											
标称静电容量	测量频率	测量电压																																																												
C≤10μF (最小10V)*	1 ± 0.1kHz	1.0 ± 0.2Vrms																																																												
C≤10μF (最大6.3V)	1 ± 0.1kHz	0.5 ± 0.1Vrms																																																												
C>10μF	120 ± 24Hz	0.5 ± 0.1Vrms																																																												
*表1的项目	1 ± 0.1kHz	0.5 ± 0.1Vrms																																																												
8	散逸因数 (D.F.)	B1, B3, R1, R6*, R7*, C7, C8, E7, D7: 最大0.1 C6: 最大0.125 D8: 最大0.15 F1, F5: 最大0.2 *GRM31CR71E106: 最大0.125 GRM31CR6 0J/0G 107: 最大0.15																																																												
9	静电容量温度特性	无偏置 B1, B3 : 在 ± 10%范围内 (- 25至 + 85°C) F1 : 在 + 30 / - 80%范围内 (- 25至 + 85°C) R6 : 在 ± 15%范围内 (- 55至 + 85°C) R1, R7 : 在 ± 15%范围内 (- 55至 + 125°C) F5 : 在 + 22 / - 82%范围内 (- 30至 + 85°C) C6 : 在 ± 22%范围内 (- 55至 + 85°C) C7 : 在 ± 22%范围内 (- 55至 + 125°C) C8 : 在 ± 22%范围内 (- 55至 + 105°C) D7 : 在 + 22 / - 33%范围内 (- 55至 + 125°C) E7 : 在 + 22 / - 56%范围内 (- 55至 + 125°C) D8 : 在 + 22 / - 33%范围内 (- 55至 + 105°C)	静电容量变化应在进入规定的各温度阶段5分钟后测量。 表中所示的温度范围内静电容量的变化较于参考温度时容量的变化都应在规定范围内。* 如果要施加电压，静电容量变化应再过1分钟后测量，以使所加电压在各温度阶段得到平衡。 *仅限GRM32DR60J226, GRM43 B1/B3/R6 0J/1A 336/476: 1.0 ± 0.2Vrms <table border="1"> <thead> <tr> <th>阶段</th> <th>温度 (°C)</th> <th>外加电压 (V)</th> </tr> </thead> <tbody> <tr> <td rowspan="2">1</td> <td>25 ± 2 (对于R6, R7, C6, C7, C8, D7, D8, E7, F5)</td> <td rowspan="8">无偏置</td> </tr> <tr> <td>20 ± 2 (对于B1, B3, F1, R1)</td> </tr> <tr> <td rowspan="3">2</td> <td>- 55 ± 3 (对于R1, R6, R7, C6, C7, C8, D7, D8, E7)</td> </tr> <tr> <td>- 30 ± 3 (对于F5)</td> </tr> <tr> <td>- 25 ± 3 (对于B1, B3, F1)</td> </tr> <tr> <td rowspan="2">3</td> <td>25 ± 2 (对于R6, R7, C6, C7, C8, D7, D8, E7, F5)</td> </tr> <tr> <td>20 ± 2 (对于B1, B3, F1, R1)</td> </tr> <tr> <td rowspan="2">4</td> <td>125 ± 3 (对于R1, R7, C7, D7, E7)</td> </tr> <tr> <td>105 ± 3 (对于C8, D8)</td> </tr> <tr> <td rowspan="2">5</td> <td>85 ± 3 (对于B1, B3, F1, F5, R6, C6)</td> </tr> <tr> <td>20 ± 2 (对于B1, F1, R1)</td> </tr> <tr> <td rowspan="2">6</td> <td>- 55 ± 3 (对于R1)</td> <td rowspan="8">50% 额定电压</td> </tr> <tr> <td>- 25 ± 3 (对于B1, F1)</td> </tr> <tr> <td rowspan="2">7</td> <td>20 ± 2 (对于B1, F1, R1)</td> </tr> <tr> <td>125 ± 3 (对于R1)</td> </tr> <tr> <td rowspan="2">8</td> <td>85 ± 3 (对于B1, F1)</td> </tr> </tbody> </table>	阶段	温度 (°C)	外加电压 (V)	1	25 ± 2 (对于R6, R7, C6, C7, C8, D7, D8, E7, F5)	无偏置	20 ± 2 (对于B1, B3, F1, R1)	2	- 55 ± 3 (对于R1, R6, R7, C6, C7, C8, D7, D8, E7)	- 30 ± 3 (对于F5)	- 25 ± 3 (对于B1, B3, F1)	3	25 ± 2 (对于R6, R7, C6, C7, C8, D7, D8, E7, F5)	20 ± 2 (对于B1, B3, F1, R1)	4	125 ± 3 (对于R1, R7, C7, D7, E7)	105 ± 3 (对于C8, D8)	5	85 ± 3 (对于B1, B3, F1, F5, R6, C6)	20 ± 2 (对于B1, F1, R1)	6	- 55 ± 3 (对于R1)	50% 额定电压	- 25 ± 3 (对于B1, F1)	7	20 ± 2 (对于B1, F1, R1)	125 ± 3 (对于R1)	8	85 ± 3 (对于B1, F1)																														
		阶段	温度 (°C)	外加电压 (V)																																																										
1	25 ± 2 (对于R6, R7, C6, C7, C8, D7, D8, E7, F5)	无偏置																																																												
	20 ± 2 (对于B1, B3, F1, R1)																																																													
2	- 55 ± 3 (对于R1, R6, R7, C6, C7, C8, D7, D8, E7)																																																													
	- 30 ± 3 (对于F5)																																																													
	- 25 ± 3 (对于B1, B3, F1)																																																													
3	25 ± 2 (对于R6, R7, C6, C7, C8, D7, D8, E7, F5)																																																													
	20 ± 2 (对于B1, B3, F1, R1)																																																													
4	125 ± 3 (对于R1, R7, C7, D7, E7)																																																													
	105 ± 3 (对于C8, D8)																																																													
5	85 ± 3 (对于B1, B3, F1, F5, R6, C6)																																																													
	20 ± 2 (对于B1, F1, R1)																																																													
6	- 55 ± 3 (对于R1)	50% 额定电压																																																												
	- 25 ± 3 (对于B1, F1)																																																													
7	20 ± 2 (对于B1, F1, R1)																																																													
	125 ± 3 (对于R1)																																																													
8	85 ± 3 (对于B1, F1)																																																													
	50% 额定电压 B1: 在 + 10 / - 30%范围内 R1: 在 + 15 / - 40%范围内 F1: 在 + 30 / - 95%范围内																																																													

接下一页。 

1 GRM系列规格和测试方法 (2) (注1) 典型检验标准

(注1) 下列规格和测试方法只表示典型检验标准。

请参照个别规格 (村田的产品规格书或产品承认书)。
 当品名表中未附有“*”时，请参见GRM系列规格和测试方法 (1)。
 当品名表中附有“*”时，请参见GRM系列规格和测试方法 (2)。

接上页。

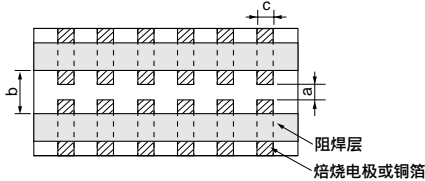
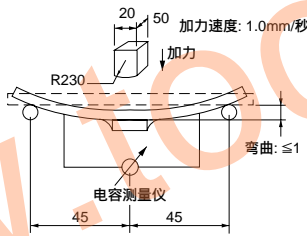
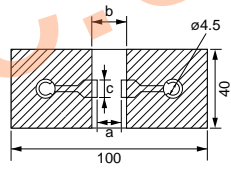
编号	项目	特性	测试方法																																												
10	端子结合强度	不应出现端子脱落或其它缺陷。  <p>图1a</p>	使用共晶锡将电容器焊接在图1a中所示的测试夹具 (玻璃环氧树脂板) 上。然后平行于测试夹具施加10N*的力10 ± 1秒。 焊接应利用烙铁或使用回流焊接方式进行，而且应谨慎作业，以使焊接均匀且不会由于热冲击产生缺陷。 *1N: GRM02, 2N: GRM03, 5N: GRM15/GRM18 <table border="1"> <thead> <tr> <th>型号</th> <th>a</th> <th>b</th> <th>c</th> </tr> </thead> <tbody> <tr><td>GRM02</td><td>0.2</td><td>0.56</td><td>0.23</td></tr> <tr><td>GRM03</td><td>0.3</td><td>0.9</td><td>0.3</td></tr> <tr><td>GRM15</td><td>0.4</td><td>1.5</td><td>0.5</td></tr> <tr><td>GRM18</td><td>1.0</td><td>3.0</td><td>1.2</td></tr> <tr><td>GRM21</td><td>1.2</td><td>4.0</td><td>1.65</td></tr> <tr><td>GRM31</td><td>2.2</td><td>5.0</td><td>2.0</td></tr> <tr><td>GRM32</td><td>2.2</td><td>5.0</td><td>2.9</td></tr> <tr><td>GRM43</td><td>3.5</td><td>7.0</td><td>3.7</td></tr> <tr><td>GRM55</td><td>4.5</td><td>8.0</td><td>5.6</td></tr> </tbody> </table>	型号	a	b	c	GRM02	0.2	0.56	0.23	GRM03	0.3	0.9	0.3	GRM15	0.4	1.5	0.5	GRM18	1.0	3.0	1.2	GRM21	1.2	4.0	1.65	GRM31	2.2	5.0	2.0	GRM32	2.2	5.0	2.9	GRM43	3.5	7.0	3.7	GRM55	4.5	8.0	5.6				
型号	a	b	c																																												
GRM02	0.2	0.56	0.23																																												
GRM03	0.3	0.9	0.3																																												
GRM15	0.4	1.5	0.5																																												
GRM18	1.0	3.0	1.2																																												
GRM21	1.2	4.0	1.65																																												
GRM31	2.2	5.0	2.0																																												
GRM32	2.2	5.0	2.9																																												
GRM43	3.5	7.0	3.7																																												
GRM55	4.5	8.0	5.6																																												
11	振荡电阻	<table border="1"> <tr> <td>外观</td> <td>无缺陷或异常</td> </tr> <tr> <td>静电容量</td> <td>在规定偏差范围内</td> </tr> <tr> <td>D.F.</td> <td> B1, B3, R1, R6*, R7*, C7, C8, E7, D7: 最大0.1 C6: 最大0.125 D8: 最大0.15 F1, F5: 最大0.2 *GRM31CR71E106: 最大0.125 GRM31CR6 0J/0G 107: 最大0.15 </td> </tr> </table>	外观	无缺陷或异常	静电容量	在规定偏差范围内	D.F.	B1, B3, R1, R6*, R7*, C7, C8, E7, D7: 最大0.1 C6: 最大0.125 D8: 最大0.15 F1, F5: 最大0.2 *GRM31CR71E106: 最大0.125 GRM31CR6 0J/0G 107: 最大0.15	按照与 (10) 相同的方法和条件，将电容器焊接在测试夹具 (玻璃环氧树脂板) 上。 电容器应进行简谐运动，其总幅值为1.5mm，频率在近似10至55Hz之间均匀变化。频率范围 (从10至55Hz再返回10Hz) 应在约1分钟内完成。振动应在3个相互垂直方向各进行2小时 (总计6小时)。 																																						
外观	无缺陷或异常																																														
静电容量	在规定偏差范围内																																														
D.F.	B1, B3, R1, R6*, R7*, C7, C8, E7, D7: 最大0.1 C6: 最大0.125 D8: 最大0.15 F1, F5: 最大0.2 *GRM31CR71E106: 最大0.125 GRM31CR6 0J/0G 107: 最大0.15																																														
12	弯曲强度	<table border="1"> <tr> <td>外观</td> <td>无明显缺陷</td> </tr> <tr> <td>静电容量变化</td> <td>在 ± 10% 范围内</td> </tr> </table>  <p>图3a</p>	外观	无明显缺陷	静电容量变化	在 ± 10% 范围内	使用共晶锡将电容器焊接在图2a中所示的测试夹具 (玻璃环氧树脂板) 上。然后在图3a所示的方向加力5 ± 1秒。焊接应使用回流焊接方法进行，而且应谨慎作业，以使焊接均匀且不会由于热冲击产生缺陷。  <p>图2a</p> <p>(GRM02/03/15: t: 0.8mm)</p> <table border="1"> <thead> <tr> <th>型号</th> <th>a</th> <th>b</th> <th>c</th> </tr> </thead> <tbody> <tr><td>GRM02</td><td>0.2</td><td>0.56</td><td>0.23</td></tr> <tr><td>GRM03</td><td>0.3</td><td>0.9</td><td>0.3</td></tr> <tr><td>GRM15</td><td>0.4</td><td>1.5</td><td>0.5</td></tr> <tr><td>GRM18</td><td>1.0</td><td>3.0</td><td>1.2</td></tr> <tr><td>GRM21</td><td>1.2</td><td>4.0</td><td>1.65</td></tr> <tr><td>GRM31</td><td>2.2</td><td>5.0</td><td>2.0</td></tr> <tr><td>GRM32</td><td>2.2</td><td>5.0</td><td>2.9</td></tr> <tr><td>GRM43</td><td>3.5</td><td>7.0</td><td>3.7</td></tr> <tr><td>GRM55</td><td>4.5</td><td>8.0</td><td>5.6</td></tr> </tbody> </table> <p>(in mm)</p>	型号	a	b	c	GRM02	0.2	0.56	0.23	GRM03	0.3	0.9	0.3	GRM15	0.4	1.5	0.5	GRM18	1.0	3.0	1.2	GRM21	1.2	4.0	1.65	GRM31	2.2	5.0	2.0	GRM32	2.2	5.0	2.9	GRM43	3.5	7.0	3.7	GRM55	4.5	8.0	5.6
外观	无明显缺陷																																														
静电容量变化	在 ± 10% 范围内																																														
型号	a	b	c																																												
GRM02	0.2	0.56	0.23																																												
GRM03	0.3	0.9	0.3																																												
GRM15	0.4	1.5	0.5																																												
GRM18	1.0	3.0	1.2																																												
GRM21	1.2	4.0	1.65																																												
GRM31	2.2	5.0	2.0																																												
GRM32	2.2	5.0	2.9																																												
GRM43	3.5	7.0	3.7																																												
GRM55	4.5	8.0	5.6																																												
13	端子可焊性	75%端子需均匀且连续焊接。	将电容器浸泡在乙醇 (JIS-K-8101) 和松香 (JIS-K-5902) (松香占25%的重量) 溶液中。 在80至120 范围内预热10至30秒。 预热后，再浸泡在230 ± 5°C的共晶锡溶液2 ± 0.5秒或在245 ± 5°C的Sn-3.0Ag-0.5Cu无铅焊锡溶液2 ± 0.5秒。																																												

接下页。

GRM系列规格和测试方法 (2) (注1) 典型检验标准

1

(注1) 下列规格和测试方法只表示典型检验标准。

请参照个别规格(村田的产品规格书或产品承认书)。

当品名表中未附有“*”时，请参见GRM系列规格和测试方法(1)。

当品名表中附有“*”时，请参见GRM系列规格和测试方法(2)。

接上页。

编号	项目	特性	测试方法															
14	外观	无缺陷或异常	在120°C至150°C范围内预热电容器1分钟。 将电容器浸泡在270 ± 5°C的共晶锡溶液或Sn-3.0Ag-0.5Cu无铅焊锡溶液10 ± 0.5秒。在常温下放置24 ± 2小时，然后进行测量。 *不适用于GRM02。 *高介电常数型的初次测量 在150 + 0/ - 10°C条件下进行1小时热处理，再在常温下放置24 ± 2小时。 之后进行初次测量。 *预热GRM32/43/55															
	静电容量变化	B1, B3, R1, R6*, R7, C6, C7, C8*, E7, D7, D8: 在 ± 7.5%范围内 F1, F5: 在 ± 20%范围内 *GRM188R6 0J/0G 106, GRM188C80E106, GRM219R60G226: 在 ± 12.5%范围内 GRM155R60G475: 在 ± 15%范围内																
	D.F.	B1, B3, R1, R6*, R7*, C7, C8, E7, D7: 最大0.1 C6: 最大0.125 D8: 最大0.15 F1, F5: 最大0.2 *GRM31CR71E106: 最大0.125 GRM31CR6 0J/0G 107: 最大0.15																
	绝缘电阻	大于50Ω · F																
	介电强度	无缺陷																
			<table border="1"> <thead> <tr> <th>阶段</th> <th>温度</th> <th>时间</th> </tr> </thead> <tbody> <tr> <td>1</td> <td>100至120°C</td> <td>1分钟</td> </tr> <tr> <td>2</td> <td>170至200°C</td> <td>1分钟</td> </tr> </tbody> </table>	阶段	温度	时间	1	100至120°C	1分钟	2	170至200°C	1分钟						
阶段	温度	时间																
1	100至120°C	1分钟																
2	170至200°C	1分钟																
15	外观	无缺陷或异常	按照与(10)相同的方法和条件，将电容器固定在支撑夹具上。 按照下表中列出的4种热处理方法执行5个周期。 在常温下放置24 ± 2小时，然后进行测量。 <table border="1"> <thead> <tr> <th>阶段</th> <th>1</th> <th>2</th> <th>3</th> <th>4</th> </tr> </thead> <tbody> <tr> <td>温度(°C)</td> <td>最低 动作温度 +0/ - 3</td> <td>常温</td> <td>最高 动作温度 +3/ - 0</td> <td>常温</td> </tr> <tr> <td>时间(分钟)</td> <td>30 ± 3</td> <td>2至3</td> <td>30 ± 3</td> <td>2至3</td> </tr> </tbody> </table> *高介电常数型的初次测量 在150 + 0/ - 10°C条件下进行1小时热处理，再在常温下放置24 ± 2小时。 之后进行初次测量。 GRM188R60J106需经热处理并在室温下放置24 ± 2小时后进行测量。	阶段	1	2	3	4	温度(°C)	最低 动作温度 +0/ - 3	常温	最高 动作温度 +3/ - 0	常温	时间(分钟)	30 ± 3	2至3	30 ± 3	2至3
	阶段	1		2	3	4												
	温度(°C)	最低 动作温度 +0/ - 3		常温	最高 动作温度 +3/ - 0	常温												
	时间(分钟)	30 ± 3		2至3	30 ± 3	2至3												
	静电容量变化	B1, B3, R1, R6, R7, C6, C7, C8, D7, D8: 在 ± 7.5%范围内 E7: 在 ± 30%范围内 F1, F5: 在 ± 20%范围内																
D.F.	B1, B3, R1, R6*, R7*, C7, C8, E7, D7: 最大0.1 C6: 最大0.125 D8: 最大0.15 F1, F5: 最大0.2 *GRM31CR71E106: 最大0.125 GRM31CR6 0J/0G 107: 最大0.15																	
绝缘电阻	大于50Ω · F																	
介电强度	无缺陷																	
16	外观	无缺陷或异常	在40 ± 2°C及90至95%湿度条件下施加额定电压500 ± 12小时。 充电/放电电流低于50mA。 *初次测量 在150 + 0/ - 10°C条件下进行1小时热处理，再在常温下放置24 ± 2小时。之后进行初次测量。 *测试后的测量 在150 + 0/ - 10°C条件下进行1小时热处理，再在常温下放置24 ± 2小时，然后进行测量。															
	静电容量变化	B1, B3, R1, R6, R7, C6, C7, C8, E7, D7, D8: 在 ± 12.5%范围内 F1, F5: 在 ± 30%范围内																
	D.F.	B1, B3, R1, R6, R7, C6, C7, C8, E7, D7, D8: 最大0.2 F1, F5: 最大0.4																
	绝缘电阻	大于12.5Ω · F																
17	外观	无缺陷或异常	在最高动作温度±3°C条件下施加150%额定电压1000 ± 12小时，再在常温下放置24 ± 2小时，然后进行测量。 充电/放电电流低于50mA。 *初次测量 在150 + 0/ - 10°C条件下进行1小时热处理，再在常温下放置24 ± 2小时。之后进行初次测量。 *测试后的测量 在150 + 0/ - 10°C条件下进行1小时热处理，再在常温下放置24 ± 2小时，然后进行测量。															
	静电容量变化	B1, B3, R1, R6*, R7, C6, C7, C8*, E7, D7, D8: 在 ± 12.5%范围内 F1, F5: 在 ± 30%范围内 *GRM188C80E106, GRM219R60G226: 在 ± 15%范围内																
	D.F.	B1, B3, R1, R6, R7, C6, C7, C8, E7, D7, D8: 最大0.2 F1, F5: 最大0.4																
	绝缘电阻	大于25Ω · F																

GRM系列数据

■ 静电容量 - 温度特性

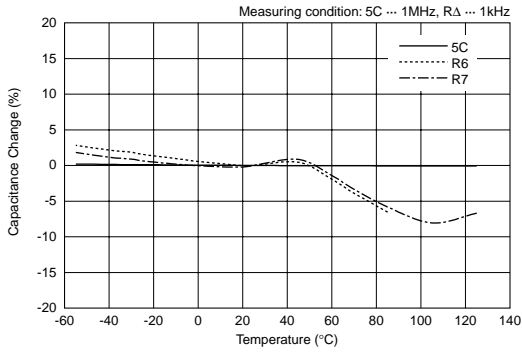

■ 静电容量变化 - 老化率

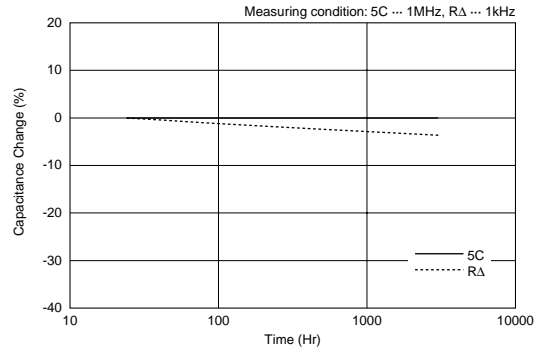

■ 阻抗 - 频率特性

5C: GRM15

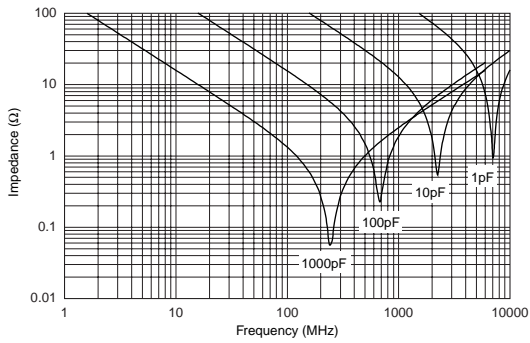

R Δ : GRM15

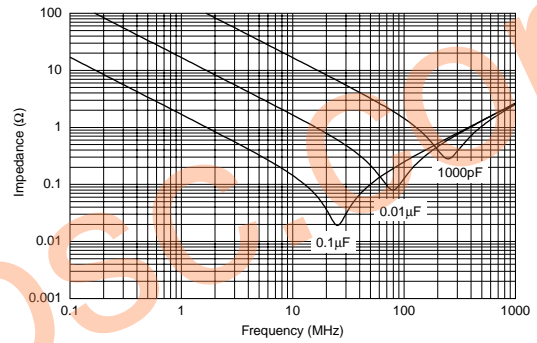

R Δ

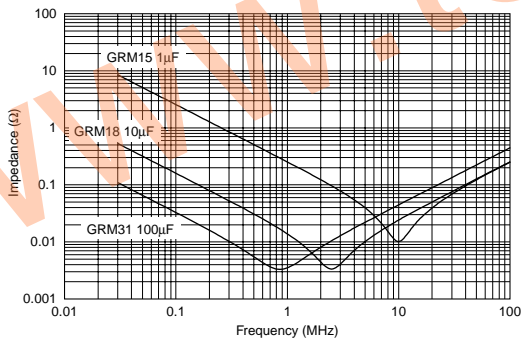

本目录中的数据为典型值，并非保证额定值。
 关于单个产品数据，请参见村田网站，或向村田制作所咨询。
 村田网站: http://www.murata.com/products/capacitor/tech_data/index.html

接下页。

☐ 接上页

■ 静电容量 - 直流电压特性

Temperature Compensating Type: GRM1555C1H102JA01

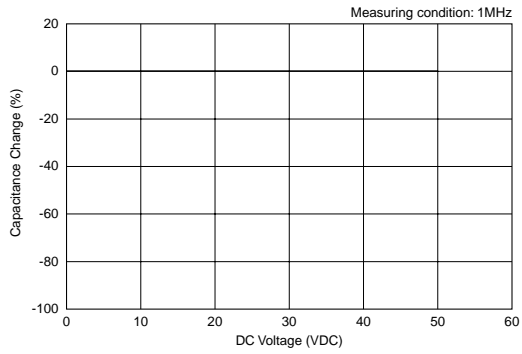

High Dielectric Constant Type: GRM155R71E103KA01

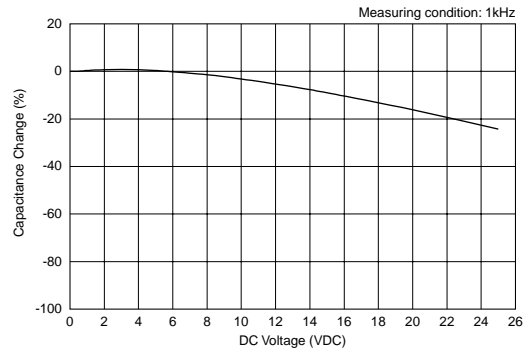

High Dielectric Constant Type: GRM155R71C104KA88

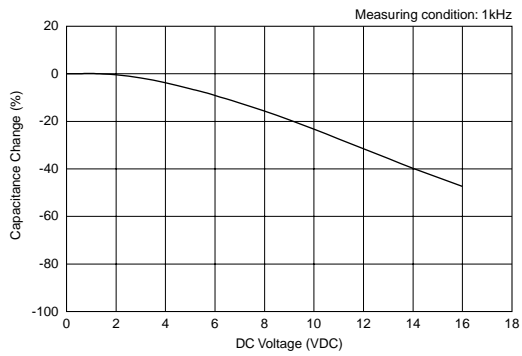

High Dielectric Constant Type: GRM155R61A105KE15

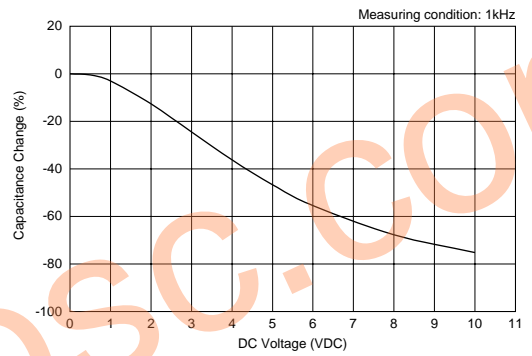

High Dielectric Constant Type: GRM188R60J106ME47

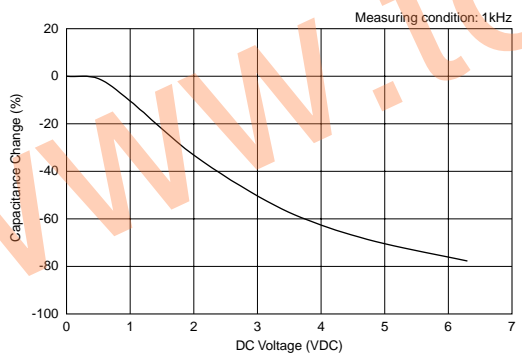

High Dielectric Constant Type: GRM31CR60J107ME39

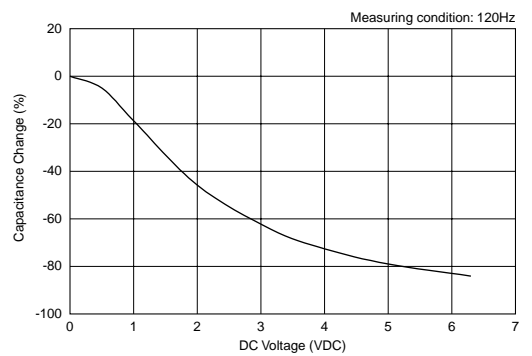

本目录中的数据为典型值，并非保证额定值。

关于单个产品数据，请参见村田网站，或向村田制作所咨询。

村田网站: http://www.murata.com/products/capacitor/tech_data/index.html

☐ 接下页

GRM系列数据

☐ 接上页

■ 静电容量 - 交流电压特性

Temperature Compensating Type: GRM1555C1H102JA01

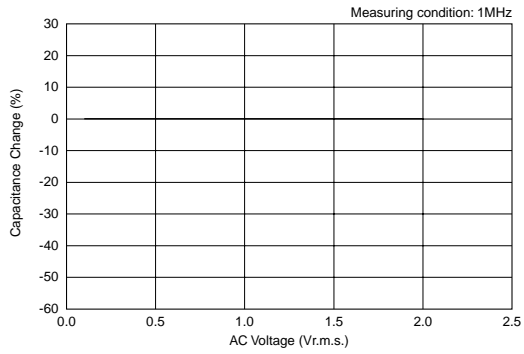

High Dielectric Constant Type: GRM155R71E103KA01

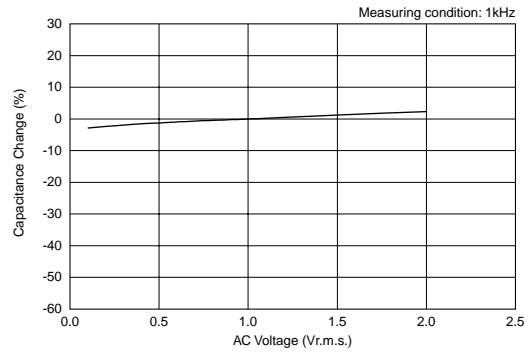

High Dielectric Constant Type: GRM155R71C104KA88

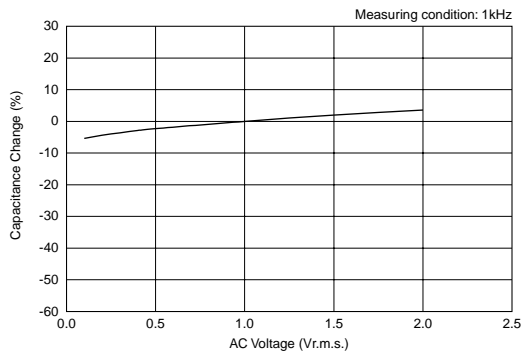

High Dielectric Constant Type: GRM155R61A105KE15

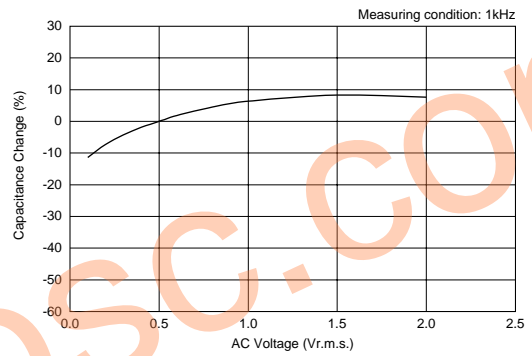

High Dielectric Constant Type: GRM188R60J106ME47

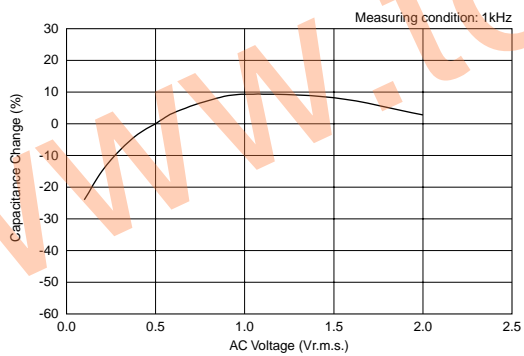

High Dielectric Constant Type: GRM31CR60J107ME39

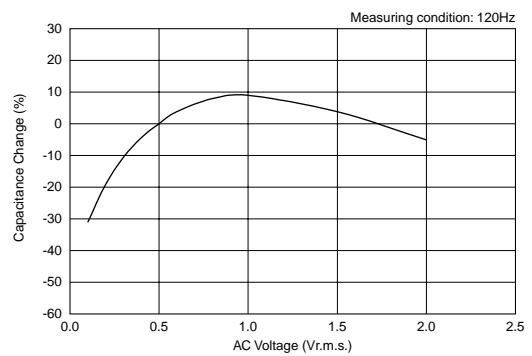

本目录中的数据为典型值，并非保证额定值。

关于单个产品数据，请参见村田网站，或向村田制作所咨询。

村田网站: http://www.murata.com/products/capacitor/tech_data/index.html

片状独石陶瓷电容器



排容 GNM系列

特点

1. 高密度安装，节省安装空间
2. 节省安装成本

用途

一般电子机器用

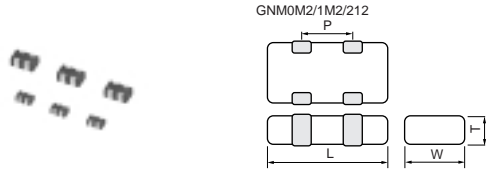

品名	尺寸 (mm)			
	长 L	宽 W	厚度 T	间距 P
GNM0M2	0.9 ±0.05	0.6 ±0.05	0.45 ±0.05	0.45 ±0.05
			0.5 +0.05/-0.10	
GNM1M2	1.37 ±0.15	1.0 ±0.15	0.6 ±0.1	0.64 ±0.05
			0.8 +0/-0.15	
GNM212	2.0 ±0.15	1.25 ±0.15	0.6 ±0.1	1.0 ±0.1
			0.85 ±0.1	

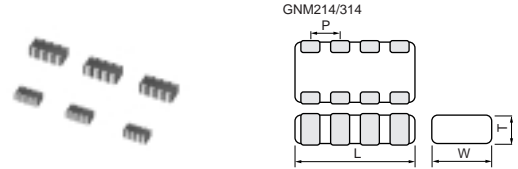

品名	尺寸 (mm)			
	长 L	宽 W	厚度 T	间距 P
GNM214	2.0 ±0.15	1.25 ±0.15	0.5 +0.05/-0.1	0.5 ±0.05
			0.6 ±0.1	
			0.85 ±0.1	
GNM314	3.2 ±0.15	1.6 ±0.15	0.8 ±0.1	0.8 ±0.1
			0.85 ±0.1	
			1.0 ±0.1	
			1.15 ±0.1	

电容表

温度补偿型 C0G(5C) 特性

0.6		例) 0.6: 厚度 [mm]			
静电容量	长x宽 [mm]	1.37x1.0 (1M) <0504>	2.0x1.25 (21) <0805>	3.2x1.6 (31) <1206>	
	单元数目	2(2)	4(4)		
额定电压 [Vdc]	50	50	100	50	
	(1H)	(1H)	(2A)	(1H)	
10pF(100)	0.6	0.6	0.8	0.8	
15pF(150)	0.6	0.6	0.8	0.8	
22pF(220)	0.6	0.6	0.8	0.8	
33pF(330)	0.6	0.6	0.8	0.8	
47pF(470)	0.6	0.6	0.8	0.8	
68pF(680)	0.6	0.6	0.8	0.8	
100pF(101)	0.6	0.6	0.8	0.8	
150pF(151)	0.6	0.6	0.8	0.8	
220pF(221)	0.6	0.6		0.8	
330pF(331)				0.8	

品名代号在()中注明，单位在 []中注明。< >: EIA [英寸] 代号

接下页。

电容表

2

高介电常数型 X7R(R7)/X7S(C7) 特性

0.6		例) 0.6: 厚度 [mm]											
长x宽 [mm]	单元数目	1.37x1.0 (1M) <0504>					2.0x1.25 (21) <0805>			3.2x1.6 (31) <1206>			
		2(2)					4(4)						
额定电压 [Vdc]		50 (1H)	25 (1E)	16 (1C)	10 (1A)	50 (1H)	25 (1E)	16 (1C)	50 (1H)	25 (1E)	16 (1C)	6.3 (0J)	
TC代号		X7R (R7)	X7R (R7)	X7R (R7)	X7S (C7)	X7R (R7)	X7R (R7)	X7R (R7)	X7R (R7)	X7R (R7)	X7R (R7)	X7R (R7)	
静电容量													
470pF(471)						0.6							
1000pF(102)	0.6					0.6							
2200pF(222)			0.6				0.6						
4700pF(472)			0.6				0.6						
10000pF(103)			0.6				0.6						
22000pF(223)				0.6	0.6			0.85					
47000pF(473)				0.6	0.6			0.85	0.85		1.0		
0.10μF(104)				0.6		0.6		0.85	0.85	0.85	1.0		
1.0μF(105)												1.15	

品名代号在()中注明，单位在 []中注明。 < >: EIA [英寸] 代号

高介电常数型 X5R(R6) 特性

0.6		例) 0.6: 厚度 [mm]															
长x宽 [mm]	单元数目	0.9x0.6 (0M) <0302>					1.37x1.0 (1M) <0504>			2.0x1.25 (21) <0805>			2.0x1.25 (21) <0805>		3.2x1.6 (31) <1206>		
		2(2)					4(4)										
额定电压 [Vdc]		16 (1C)	10 (1A)	6.3 (0J)	4 (0G)	50 (1H)	25 (1E)	16 (1C)	10 (1A)	6.3 (0J)	16 (1C)	10 (1A)	6.3 (0J)	10 (1A)	6.3 (0J)	16 (1C)	10 (1A)
TC代号		X5R (R6)	X5R (R6)	X5R (R6)	X5R (R6)	X5R (R6)	X5R (R6)	X5R (R6)	X5R (R6)	X5R (R6)	X5R (R6)	X5R (R6)	X5R (R6)	X5R (R6)	X5R (R6)	X5R (R6)	X5R (R6)
静电容量																	
1000pF(102)						0.6											
2200pF(222)						0.6											
4700pF(472)						0.6											
10000pF(103)		0.45	0.45	0.45		0.6											
22000pF(223)		0.45	0.45	0.45			0.6	0.6									
47000pF(473)		0.45	0.45	0.45			0.6	0.6									
0.10μF(104)		0.45	0.45	0.45				0.6									
0.22μF(224)								0.8									
0.47μF(474)										0.85							
1.0μF(105)					0.45			0.8	0.8	0.8	0.85	0.85		0.85	0.85	0.85	0.85
2.2μF(225)									0.8	0.8		0.85	0.85		0.85		

品名代号在()中注明，单位在 []中注明。 < >: EIA [英寸] 代号

高介电常数型 X7R(R7) 特性 薄型

0.5		例) 0.5: 厚度 [mm]	
长x宽 [mm]	单元数目	1.37x1.0 (1M) <0504>	2.0x1.25 (21) <0805>
		2(2)	4(4)
额定电压 [Vdc]		16 (1C)	16 (1C)
TC代号		X7R (R7)	X7R (R7)
静电容量			
0.10μF(104)		0.5	0.5

品名代号在()中注明，单位在 []中注明。
< >: EIA [英寸] 代号

高介电常数型 X5R(R6) 特性 薄型

0.5		例) 0.5: 厚度 [mm]		
长x宽 [mm]	单元数目	1.37x1.0 (1M) <0504>	2.0x1.25 (21) <0805>	
		2(2)	4(4)	
额定电压 [Vdc]		16 (1C)	10 (1A)	16 (1C)
TC代号		X5R (R6)	X5R (R6)	X5R (R6)
静电容量				
1.0μF(105)		0.5	0.5	0.5

品名代号在()中注明，单位在 []中注明。
< >: EIA [英寸] 代号

温度补偿型 C0G(5C) 特性

长x宽 [mm]		1.37x1.0(1M)<0504>	2.0x1.25(21)<0805>	3.2x1.6(31)<1206>	
额定电压 [Vdc]		50(1H)	50(1H)	100(2A)	50(1H)
静电容量	公差	品名			
10pF(100)	±10%(K)	GNM1M25C1H100KD01D	GNM2145C1H100KD01D	GNM3145C2A100KD01D	GNM3145C1H100KD01D
15pF(150)	±10%(K)	GNM1M25C1H150KD01D	GNM2145C1H150KD01D	GNM3145C2A150KD01D	GNM3145C1H150KD01D
22pF(220)	±10%(K)	GNM1M25C1H220KD01D	GNM2145C1H220KD01D	GNM3145C2A220KD01D	GNM3145C1H220KD01D
33pF(330)	±10%(K)	GNM1M25C1H330KD01D	GNM2145C1H330KD01D	GNM3145C2A330KD01D	GNM3145C1H330KD01D
47pF(470)	±10%(K)	GNM1M25C1H470KD01D	GNM2145C1H470KD01D	GNM3145C2A470KD01D	GNM3145C1H470KD01D
68pF(680)	±10%(K)	GNM1M25C1H680KD01D	GNM2145C1H680KD01D	GNM3145C2A680KD01D	GNM3145C1H680KD01D
100pF(101)	±10%(K)	GNM1M25C1H101KD01D	GNM2145C1H101KD01D	GNM3145C2A101KD01D	GNM3145C1H101KD01D
150pF(151)	±10%(K)	GNM1M25C1H151KD01D	GNM2145C1H151KD01D	GNM3145C2A151KD01D	GNM3145C1H151KD01D
220pF(221)	±10%(K)	GNM1M25C1H221KD01D	GNM2145C1H221KD01D		GNM3145C1H221KD01D
330pF(331)	±10%(K)				GNM3145C1H331KD01D

品名代号在()中注明, 单位在 []中注明。< >: EIA [英寸] 代号

高介电常数型 X7R(R7)/X7S(C7)特性

长x宽 [mm]		1.37x1.0(1M)<0504>			
单元数目		2(2)			
额定电压 [Vdc]		50(1H)	25(1E)	16(1C)	10(1A)
静电容量	公差	品名			
1000pF(102)	±20%(M)	GNM1M2R71H102MA01D			
2200pF(222)	±20%(M)		GNM1M2R71E222MA01D		
4700pF(472)	±20%(M)		GNM1M2R71E472MA01D		
10000pF(103)	±20%(M)		GNM1M2R71E103MA01D		
22000pF(223)	±20%(M)			GNM1M2R71C223MA01D	GNM1M2R71A223MA01D
47000pF(473)	±20%(M)			GNM1M2R71C473MA01D	GNM1M2R71A473MA01D
0.10μF(104)	±20%(M)			GNM1M2R71C104MA01D	GNM1M2C71A104MA01D

长x宽 [mm]		2.0x1.25(21)<0805>		
单元数目		4(4)		
额定电压 [Vdc]		50(1H)	25(1E)	16(1C)
静电容量	公差	品名		
470pF(471)	±20%(M)	GNM214R71H471MA01D		
1000pF(102)	±20%(M)	GNM214R71H102MA01D		
2200pF(222)	±20%(M)		GNM214R71E222MA01D	
4700pF(472)	±20%(M)		GNM214R71E472MA01D	
10000pF(103)	±20%(M)		GNM214R71E103MA01D	
22000pF(223)	±20%(M)			GNM214R71C223MA01D
47000pF(473)	±20%(M)			GNM214R71C473MA01D
0.10μF(104)	±20%(M)			GNM214R71C104MA01D

长x宽 [mm]		3.2x1.6(31)<1206>			
单元数目		4(4)			
额定电压 [Vdc]		50(1H)	25(1E)	16(1C)	6.3(0J)
静电容量	公差	品名			
47000pF(473)	±20%(M)	GNM314R71H473MA11D		GNM314R71C473MA01L	
0.10μF(104)	±20%(M)	GNM314R71H104MA11D	GNM314R71E104MA11D	GNM314R71C104MA01L	
1.0μF(105)	±20%(M)				GNM314R70J105MA01L

品名代号在()中注明, 单位在 []中注明。< >: EIA [英寸] 代号

*: 请参见GNM系列规格和测试方法 (2)。

- | | | | | | | | | | | | | | | | |
|------|-----------|----------|-----------|----------|-----------|-----------|------------|----------|------------|----------|-------|-------|----------|---------|-------|
| (品名) | GN | M | 1M | 2 | 5C | 1H | 100 | K | D01 | D | ①型号 | ②系列 | ③尺寸(长×宽) | ④单元数目 | ⑤温度特性 |
| | ① | ② | ③ | ④ | ⑤ | ⑥ | ⑦ | ⑧ | ⑨ | ⑩ | ⑥额定电压 | ⑦静电容量 | ⑧静电容量公差 | ⑨个别规格代号 | ⑩包装 |

品名中的包装代号表示标准180mm卷盘。

高介电常数型 X5R(R6) 特性

2

长x宽 [mm]		0.9x0.6(0M)<0302>			
单元数目		2(2)			
额定电压 [Vdc]		16(1C)	10(1A)	6.3(0J)	4(0G)
静电容量	公差	品名			
10000pF(103)	±20%(M)	GNM0M2R61C103ME18D*	GNM0M2R61A103ME17D*	GNM0M2R60J103ME17D*	
22000pF(223)	±20%(M)	GNM0M2R61C223ME18D*	GNM0M2R61A223ME17D*	GNM0M2R60J223ME17D*	
47000pF(473)	±20%(M)	GNM0M2R61C473ME18D*	GNM0M2R61A473ME17D*	GNM0M2R60J473ME17D*	
0.10μF(104)	±20%(M)	GNM0M2R61C104ME18D*	GNM0M2R61A104ME17D*	GNM0M2R60J104ME17D*	
1.0μF(105)	±20%(M)				GNM0M2R60G105ME17D*

长x宽 [mm]		1.37x1.0(1M)<0504>			
单元数目		2(2)			
额定电压 [Vdc]		50(1H)	25(1E)	16(1C)	
静电容量	公差	品名			
1000pF(102)	±20%(M)	GNM1M2R61H102MA01D			
2200pF(222)	±20%(M)		GNM1M2R61E222MA01D		
4700pF(472)	±20%(M)		GNM1M2R61E472MA01D		
10000pF(103)	±20%(M)		GNM1M2R61E103MA01D		
22000pF(223)	±20%(M)			GNM1M2R61C223MA01D	
47000pF(473)	±20%(M)			GNM1M2R61C473MA01D	
0.22μF(224)	±20%(M)			GNM1M2R61C224ME18D*	
1.0μF(105)	±20%(M)			GNM1M2R61C105ME18D*	

长x宽 [mm]		1.37x1.0(1M)<0504>			
单元数目		2(2)			
额定电压 [Vdc]		10(1A)	6.3(0J)		
静电容量	公差	品名			
22000pF(223)	±20%(M)	GNM1M2R61A223MA01D			
47000pF(473)	±20%(M)	GNM1M2R61A473MA01D			
0.10μF(104)	±20%(M)	GNM1M2R61A104MA01D			
1.0μF(105)	±20%(M)	GNM1M2R61A105ME17D*	GNM1M2R60J105ME12D*		
2.2μF(225)	±20%(M)	GNM1M2R61A225ME18D*	GNM1M2R60J225ME18D*		

长x宽 [mm]		2.0x1.25(21)<0805>			
单元数目		2(2)			
额定电压 [Vdc]		16(1C)	10(1A)	6.3(0J)	
静电容量	公差	品名			
0.47μF(474)	±20%(M)	GNM212R61C474MA16D			
1.0μF(105)	±20%(M)	GNM212R61C105MA16D	GNM212R61A105MA13D		
2.2μF(225)	±20%(M)		GNM212R61A225ME16D*	GNM212R60J225ME16D*	

品名代号在()中注明，单位在 []中注明。< >: EIA [英寸] 代号
 *: 请参见GNM系列规格和测试方法 (2)。

- | | | | | | | | | | | | | | | | |
|------|----|---|----|---|----|----|-----|---|-----|---|-------|-------|----------|---------|-------|
| (品名) | GN | M | 0M | 2 | R6 | 1C | 103 | M | E18 | D | ①型号 | ②系列 | ③尺寸(长×宽) | ④单元数目 | ⑤温度特性 |
| | ① | ② | ③ | ④ | ⑤ | ⑥ | ⑦ | ⑧ | ⑨ | ⑩ | ⑥额定电压 | ⑦静电容量 | ⑧静电容量公差 | ⑨个别规格代号 | ⑩包装 |

品名中的包装代号表示标准浅盘。

高介电常数型 X5R(R6) 特性

长x宽 [mm]	2.0x1.25(21)<0805>		
单元数目	4(4)		
额定电压 [Vdc]	10(1A)	6.3(0J)	
静电容量	公差	品名	
1.0μF(105)	±20%(M)	GNM214R61A105ME17D*	GNM214R60J105ME17D*
2.2μF(225)	±20%(M)		GNM214R60J225ME18D*

长x宽 [mm]	3.2x1.6(31)<1206>		
单元数目	4(4)		
额定电压 [Vdc]	16(1C)	10(1A)	
静电容量	公差	品名	
1.0μF(105)	±20%(M)	GNM314R61C105MA15D	GNM314R61A105MA13D

品名代号在()中注明，单位在 []中注明。< >: EIA [英寸] 代号

*: 请参见GNM系列规格和测试方法 (2)。

高介电常数型 X7R(R7) 特性 薄型

长x宽 [mm]	1.37x1.0(1M)<0504>	2.0x1.25(21)<0805>
单元数目	2(2)	4(4)
额定电压 [Vdc]	16(1C)	16(1C)
静电容量	公差	品名
0.10μF(104)	±20%(M)	GNM1M2R71C104MAA1D GNM214R71C104MAA1D

高介电常数型 X5R(R6) 特性 薄型

长x宽 [mm]	1.37x1.0(1M)<0504>		
单元数目	2(2)		
额定电压 [Vdc]	16(1C)	10(1A)	
静电容量	公差	品名	
1.0μF(105)	±20%(M)	GNM1M2R61C105MEA2D*	GNM1M2R61A105MEA4D*

品名代号在()中注明，单位在 []中注明。< >: EIA [英寸] 代号

*: 请参见GNM系列规格和测试方法 (2)。

GNM系列规格和测试方法 (1)

当品名表中未附有“*”时，请参见GNM系列规格和测试方法(1)。
 当品名表中附有“*”时，请参见GNM系列规格和测试方法(2)。

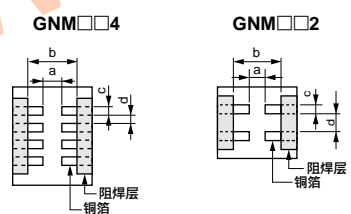
编号	项目	特性		测试方法																								
		温度补偿型	高介电常数型																									
1	动作温度范围	5C: -55至+125°C	R7, C7: -55至+125°C R6: -55至+85°C																									
2	额定电压	参见上页		额定电压定义为可向电容器连续施加的最大电压。 当交流电压附加于直流电压时，V ^{P-P} 或V ^{O-P} (以较大者为准) 应维持在额定电压范围内。																								
3	外观	无缺陷或异常		目视检查																								
4	尺寸	在规定尺寸范围内		使用游标卡尺																								
5	介电强度	无缺陷或异常		在两个端子之间施加300%额定电压(5C)或250%额定电压(R7) 1至5秒时不应观察到任何故障，并且充电/放电电流低于50mA。																								
6	绝缘电阻	大于10,000MΩ或500Ω·F (以较小者为准)		绝缘电阻应在25°C且最大相对湿度为75%条件下用不超过额定电压的直流电压测量，时间应选在充电开始后2分钟内。																								
7	静电容量	在规定偏差范围内		静电容量/Q/D.F.值应在25°C条件下，按表内的频率及电压测量。																								
8	Q/散逸因数(D.F.)	30pF最小: Q _≥ 1000 30pF最大: Q _≥ 400+20C C: 标称静电容量(pF)	<table border="1"> <thead> <tr> <th>特性</th> <th>最小25V</th> <th>16V</th> <th>10V</th> <th>6.3V</th> </tr> </thead> <tbody> <tr> <td>R7, R6, C7</td> <td>最大 0.025</td> <td>最大 0.035</td> <td>最大 0.035</td> <td>最大 0.05</td> </tr> </tbody> </table>	特性	最小25V	16V	10V	6.3V	R7, R6, C7	最大 0.025	最大 0.035	最大 0.035	最大 0.05	<table border="1"> <thead> <tr> <th>特性</th> <th>5C</th> <th>R7</th> </tr> </thead> <tbody> <tr> <td>频率</td> <td>1 ± 0.1MHz</td> <td>1 ± 0.1kHz</td> </tr> <tr> <td>电压</td> <td>0.5至5Vrms</td> <td>1.0 ± 0.2Vrms</td> </tr> </tbody> </table>	特性	5C	R7	频率	1 ± 0.1MHz	1 ± 0.1kHz	电压	0.5至5Vrms	1.0 ± 0.2Vrms					
			特性	最小25V	16V	10V	6.3V																					
R7, R6, C7	最大 0.025	最大 0.035	最大 0.035	最大 0.05																								
特性	5C	R7																										
频率	1 ± 0.1MHz	1 ± 0.1kHz																										
电压	0.5至5Vrms	1.0 ± 0.2Vrms																										
9	静电容量变化	<table border="1"> <thead> <tr> <th>特性</th> <th>温度范围</th> <th>参考温度</th> <th>静电容量变化</th> </tr> </thead> <tbody> <tr> <td>R7</td> <td>-55至+125°C</td> <td rowspan="3">25°C</td> <td rowspan="2">在 ± 15% 范围内</td> </tr> <tr> <td>R6</td> <td>-55至+85°C</td> </tr> <tr> <td>C7</td> <td>-55至+125°C</td> <td>在 ± 22% 范围内</td> </tr> </tbody> </table>	特性	温度范围	参考温度	静电容量变化	R7	-55至+125°C	25°C	在 ± 15% 范围内	R6	-55至+85°C	C7	-55至+125°C	在 ± 22% 范围内	<p>静电容量变化应在进入规定的各温度阶段5分钟后测量。</p> <p>(1) 温度补偿型 温度系数使用在第3阶段中测得的静电容量作为参考来确定。在依次通过第1至第5阶段的温度时，静电容量应在表A规定的温度系数和静电容量变化偏差范围内。 静电容量漂移是将在第1、3及5阶段测得的最大和最小值之间的差除以第3阶段的静电容量值计算而得。</p> <table border="1"> <thead> <tr> <th>阶段</th> <th>温度(°C)</th> </tr> </thead> <tbody> <tr> <td>1</td> <td>25 ± 2</td> </tr> <tr> <td>2</td> <td>-55 ± 3 (对于5C/R7/C7), -30 ± 3 (对于F5)</td> </tr> <tr> <td>3</td> <td>25 ± 2</td> </tr> <tr> <td>4</td> <td>125 ± 3 (对于5C/R7/C7), 85 ± 3 (对于F5)</td> </tr> <tr> <td>5</td> <td>25 ± 2</td> </tr> </tbody> </table> <p>(2) 高介电常数型 表中所示的温度范围内静电容量的变化较于参考温度时容量的变化都应在规定范围内。</p> <p>•高介电常数型的初次测量 在150 ± 0 / - 10°C条件下进行1小时热处理，再在常温下放置24 ± 2小时。 之后进行初次测量。</p>	阶段	温度(°C)	1	25 ± 2	2	-55 ± 3 (对于5C/R7/C7), -30 ± 3 (对于F5)	3	25 ± 2	4	125 ± 3 (对于5C/R7/C7), 85 ± 3 (对于F5)	5	25 ± 2
特性	温度范围	参考温度	静电容量变化																									
R7	-55至+125°C	25°C	在 ± 15% 范围内																									
R6	-55至+85°C																											
C7	-55至+125°C		在 ± 22% 范围内																									
阶段	温度(°C)																											
1	25 ± 2																											
2	-55 ± 3 (对于5C/R7/C7), -30 ± 3 (对于F5)																											
3	25 ± 2																											
4	125 ± 3 (对于5C/R7/C7), 85 ± 3 (对于F5)																											
5	25 ± 2																											
10	端子结合强度	不应出现端子脱落或其它缺陷。		使用共晶锡将电容器焊接在图1中所示的测试夹具(玻璃环氧树脂板)上。然后平行于测试夹具施加5N的力10 ± 1秒。 焊接应利用烙铁或使用回流焊接方式进行，而且应谨慎作业，以使焊接均匀且不会由于热冲击产生缺陷。																								
			<table border="1"> <thead> <tr> <th>型号</th> <th>a</th> <th>b</th> <th>c</th> <th>d</th> </tr> </thead> <tbody> <tr> <td>GNM1M2</td> <td>0.5</td> <td>1.6</td> <td>0.32</td> <td>0.32</td> </tr> <tr> <td>GNM212</td> <td>0.6</td> <td>1.8</td> <td>0.5</td> <td>0.5</td> </tr> <tr> <td>GNM214</td> <td>0.6</td> <td>2.0</td> <td>0.25</td> <td>0.25</td> </tr> <tr> <td>GNM314</td> <td>0.8</td> <td>2.5</td> <td>0.4</td> <td>0.4</td> </tr> </tbody> </table> <p style="text-align: right;">(in mm)</p> <p style="text-align: center;">图1</p>		型号	a	b	c	d	GNM1M2	0.5	1.6	0.32	0.32	GNM212	0.6	1.8	0.5	0.5	GNM214	0.6	2.0	0.25	0.25	GNM314	0.8	2.5	0.4
型号	a	b	c	d																								
GNM1M2	0.5	1.6	0.32	0.32																								
GNM212	0.6	1.8	0.5	0.5																								
GNM214	0.6	2.0	0.25	0.25																								
GNM314	0.8	2.5	0.4	0.4																								
11	振荡电阻	外观	无缺陷或异常		按照与(10)相同的方法和条件，将电容器焊接在测试夹具(玻璃环氧树脂板)上。 电容器应进行简谐运动，其总幅值为1.5mm，频率在近似10至55Hz之间均匀变化。频率范围(从10至55Hz再返回10Hz)应在约1分钟内完成。 振动应在3个相互垂直方向各进行2小时(总计6小时)。																							
		静电容量	在规定偏差范围内																									
	Q/D.F.	最小30pF: Q _≥ 1000 最大30pF: Q _≥ 400+20C C: 标称静电容量(pF)	<table border="1"> <thead> <tr> <th>特性</th> <th>最小25V</th> <th>16V</th> <th>10V</th> <th>6.3V</th> </tr> </thead> <tbody> <tr> <td>R7, R6, C7</td> <td>最大 0.025</td> <td>最大 0.035</td> <td>最大 0.035</td> <td>最大 0.05</td> </tr> </tbody> </table>	特性	最小25V	16V	10V	6.3V	R7, R6, C7	最大 0.025	最大 0.035	最大 0.035	最大 0.05															
特性	最小25V	16V	10V	6.3V																								
R7, R6, C7	最大 0.025	最大 0.035	最大 0.035	最大 0.05																								

接下页。 

GNM系列规格和测试方法 (1)

☐ 接上页。

当品名表中未附有“*”时，请参见GNM系列规格和测试方法(1)。
当品名表中附有“*”时，请参见GNM系列规格和测试方法(2)。

编号	项目	特性		测试方法																									
		温度补偿型	高介电常数型																										
12	外观	无明显缺陷		使用共晶锡将电容器焊接在图2中所示的测试夹具(玻璃环氧树脂板)上。然后在图3所示的方向加力5±1秒。焊接应使用回流焊接方法进行，而且应谨慎作业，以使焊接均匀且不会由于热冲击产生缺陷。																									
	静电容量变化	在±5%或±0.5pF(以较大者为准)范围内	在±10%范围内																										
<table border="1" style="margin: 10px auto; border-collapse: collapse;"> <thead> <tr> <th>型号</th> <th>a</th> <th>b</th> <th>c</th> <th>d</th> </tr> </thead> <tbody> <tr> <td>GNM1M2</td> <td>2.0 ± 0.05</td> <td>0.5 ± 0.05</td> <td>0.32 ± 0.05</td> <td>0.32 ± 0.05</td> </tr> <tr> <td>GNM212</td> <td>2.0 ± 0.05</td> <td>0.6 ± 0.05</td> <td>0.5 ± 0.05</td> <td>0.5 ± 0.05</td> </tr> <tr> <td>GNM214</td> <td>2.0 ± 0.05</td> <td>0.7 ± 0.05</td> <td>0.3 ± 0.05</td> <td>0.2 ± 0.05</td> </tr> <tr> <td>GNM314</td> <td>2.5 ± 0.05</td> <td>0.8 ± 0.05</td> <td>0.4 ± 0.05</td> <td>0.4 ± 0.05</td> </tr> </tbody> </table> <p style="text-align: center;">(in mm)</p>					型号	a	b	c	d	GNM1M2	2.0 ± 0.05	0.5 ± 0.05	0.32 ± 0.05	0.32 ± 0.05	GNM212	2.0 ± 0.05	0.6 ± 0.05	0.5 ± 0.05	0.5 ± 0.05	GNM214	2.0 ± 0.05	0.7 ± 0.05	0.3 ± 0.05	0.2 ± 0.05	GNM314	2.5 ± 0.05	0.8 ± 0.05	0.4 ± 0.05	0.4 ± 0.05
型号	a	b	c	d																									
GNM1M2	2.0 ± 0.05	0.5 ± 0.05	0.32 ± 0.05	0.32 ± 0.05																									
GNM212	2.0 ± 0.05	0.6 ± 0.05	0.5 ± 0.05	0.5 ± 0.05																									
GNM214	2.0 ± 0.05	0.7 ± 0.05	0.3 ± 0.05	0.2 ± 0.05																									
GNM314	2.5 ± 0.05	0.8 ± 0.05	0.4 ± 0.05	0.4 ± 0.05																									
图2																													
13	端子可焊性	75%端子需均匀且连续焊接。		将电容器浸泡在乙醇(JIS-K-8101)和松香(JIS-K-5902)(松香占25%的重量)溶液中。在80至120°C范围内预热10至30秒。预热后，再浸泡在230±5°C的共晶锡溶液2±0.5秒或在245±5°C的Sn-3.0Ag-0.5Cu无铅焊锡溶液2±0.5秒。																									
14	测量及观测到的特性应满足下表规定。																												
	外观	无明显缺陷		在120°C至150°C范围内预热电容器1分钟。 将电容器浸泡在270±5°C的共晶锡溶液或Sn-3.0Ag-0.5Cu无铅焊锡溶液10±0.5秒。在常温下放置24±2小时，然后进行测量。 • 高介电常数型的初次测量 在150+0/-10条件下进行1小时热处理，然后在常温下放置24±2小时。之后进行初次测量。																									
	静电容量变化	在±2.5%或±0.25pF(以较大者为准)范围内	R7, R6, C7: 在±7.5%范围内																										
	Q/D.F.	最小30pF: Q≥1000 最大30pF: Q≥400+20C C: 标称静电容量(pF)	<table border="1" style="border-collapse: collapse; text-align: center;"> <thead> <tr> <th>特性</th> <th>最小25V</th> <th>16V</th> <th>10V</th> <th>6.3V</th> </tr> </thead> <tbody> <tr> <td>R7, R6, C7</td> <td>最大</td> <td>最大</td> <td>最大</td> <td>最大</td> </tr> <tr> <td></td> <td>0.025</td> <td>0.035</td> <td>0.035</td> <td>0.05</td> </tr> </tbody> </table>		特性	最小25V	16V	10V	6.3V	R7, R6, C7	最大	最大	最大	最大		0.025	0.035	0.035	0.05										
	特性	最小25V	16V		10V	6.3V																							
R7, R6, C7	最大	最大	最大		最大																								
	0.025	0.035	0.035	0.05																									
I.R.	大于10,000MΩ或500Ω·F(以较小者为准)																												
介电强度	无失效																												
15	测量及观测到的特性应满足下表规定。																												
	外观	无明显缺陷		按照与(10)相同的方法和条件，将电容器固定在支撑夹具上。按照下表中列出的4种热处理方法执行5个周期。在常温下放置24±2小时(温度补偿型)或48±4小时(高介电常数型)，然后进行测量。 <table border="1" style="border-collapse: collapse; text-align: center; margin: 10px auto;"> <thead> <tr> <th>阶段</th> <th>1</th> <th>2</th> <th>3</th> <th>4</th> </tr> </thead> <tbody> <tr> <td>温度(°C)</td> <td>最低动作温度 +0/-3</td> <td>常温</td> <td>最高动作温度 +3/-0</td> <td>常温</td> </tr> <tr> <td>时间(分钟)</td> <td>30±3</td> <td>2至3</td> <td>30±3</td> <td>2至3</td> </tr> </tbody> </table> • 高介电常数型的初次测量 在150+0/-10°C条件下进行1小时热处理，然后在常温下放置24±2小时后进行测量。之后进行初次测量。	阶段	1	2	3	4	温度(°C)	最低动作温度 +0/-3	常温	最高动作温度 +3/-0	常温	时间(分钟)	30±3	2至3	30±3	2至3										
	阶段	1	2		3	4																							
	温度(°C)	最低动作温度 +0/-3	常温		最高动作温度 +3/-0	常温																							
	时间(分钟)	30±3	2至3		30±3	2至3																							
静电容量变化	在±2.5%或±0.25pF(以较大者为准)范围内	R7, R6, C7: 在±7.5%范围内																											
Q/D.F.	最小30pF: Q≥1000 最大30pF: Q≥400+20C C: 标称静电容量(pF)	<table border="1" style="border-collapse: collapse; text-align: center;"> <thead> <tr> <th>特性</th> <th>最小25V</th> <th>16V</th> <th>10V</th> <th>6.3V</th> </tr> </thead> <tbody> <tr> <td>R7, R6, C7</td> <td>最大</td> <td>最大</td> <td>最大</td> <td>最大</td> </tr> <tr> <td></td> <td>0.025</td> <td>0.035</td> <td>0.035</td> <td>0.05</td> </tr> </tbody> </table>	特性	最小25V	16V	10V	6.3V	R7, R6, C7	最大	最大	最大	最大		0.025	0.035	0.035	0.05												
特性	最小25V	16V	10V	6.3V																									
R7, R6, C7	最大	最大	最大	最大																									
	0.025	0.035	0.035	0.05																									
绝缘电阻	大于10,000MΩ或500Ω·F(以较小者为准)																												
介电强度	无失效																												

☐ 接下页。

GNM系列规格和测试方法 (1)

☐ 接上页。

当品名表中未附有“*”时，请参见GNM系列规格和测试方法(1)。
 当品名表中附有“*”时，请参见GNM系列规格和测试方法(2)。

编号	项目	特性				测试方法
		温度补偿型		高介电常数型		
16	湿度， 稳态	测量及观测到的特性应满足下表规定。				在40 ± 2°C及90至95%湿度条件下放置500 ± 12小时。 撤到常温下放置24 ± 2小时，然后进行测量。
		外观	无明显缺陷			
		静电容量 变化	在 ± 5%或 ± 0.5pF (以较大者为准) 范围内			
		Q/D.F.	30pF及以上: Q ≥ 350 10pF及以上, 30pF及以下: Q ≥ 275 + 5C/2 10pF及以下: Q ≥ 200 + 10C C: 标称静电容量 (pF)			
	绝缘电阻	大于1,000MΩ或50Ω · F (以较小者为准)				
17	湿度负荷	测量及观测到的特性应满足下表规定。				在40 ± 2°C及90至95%湿度条件下施加额定电压500 ± 12小时。 撤到常温下放置24 ± 2小时，然后进行测量。 充电/放电电流低于50mA。
		外观	无明显缺陷			
		静电容量 变化	在 ± 7.5% 或 ± 0.75pF (以较大者为准) 范围内			
		Q/D.F.	30pF及以上: Q ≥ 200 30pF及以下: Q ≥ 100 + 10C/3 C: 标称静电容量 (pF)			
	绝缘电阻	大于500MΩ或25Ω · F (以较小者为准)				
18	高温负荷	测量及观测到的特性应满足下表规定。				在最高动作温度 ± 3°C条件下施加200%额定电压1000 ± 12小时。 在常温下放置24 ± 2小时，然后进行测量。 充电/放电电流低于50mA。 • 高介电常数型的初次测量 在最高动作温度 ± 3°C条件下施加200%直流额定电压1小时。 撤到常温下放置24 ± 2小时，然后进行初次测量。
		外观	无明显缺陷			
		静电容量 变化	在 ± 3%或 ± 0.3pF (以较大者为准) 范围内			
		Q/D.F.	30pF及以上: Q ≥ 350 10pF及以上, 30pF及以下: Q ≥ 275 + 5C/2 10pF及以下: Q ≥ 200 + 10C C: 标称静电容量 (pF)			
	绝缘电阻	大于1,000MΩ或50Ω · F (以较小者为准)				

表A

特性代号	标称值 (ppm/°C) *1	与25°C静电容量值相比的变化 (%)					
		- 55°C		- 30°C		- 10°C	
		最大	最小	最大	最小	最大	最小
5C	0 ± 30	0.58	-0.24	0.40	-0.17	0.25	-0.11

*1: 标称值表示在25至125°C范围内的温度系数。

GNM系列规格和测试方法 (2)

当品名表中未附有“*”时，请参见GNM系列规格和测试方法(1)。
当品名表中附有“*”时，请参见GNM系列规格和测试方法(2)。

编号	项目	特性	测试方法																														
1	动作温度范围	R6: - 55°C至 + 85°C																															
2	额定电压	参见上页	额定电压定义为可向电容器连续施加的最大电压。 当交流电压附加于直流电压时， V^{P-P} 或 V^{O-P} (以较大者为准) 应维持在额定电压范围内。																														
3	外观	无缺陷或异常	目视检查																														
4	尺寸	在规定尺寸范围内	使用游标卡尺																														
5	介电强度	无缺陷或异常	在两个端子之间施加250%额定电压1至5秒时不应观察到任何故障，并且充电/放电电流低于50mA。																														
6	绝缘电阻	最小50Ω · F	绝缘电阻应在25°C且最大相对湿度为75%条件下用不超过额定电压的直流电压测量，时间应选在充电开始后1分钟内。																														
7	静电容量	在规定偏差范围内	静电容量/D.F.值应在25°C条件下，按表内的频率及电压测量。																														
8	散逸因数 (D.F.)	最大0.1* ³ 表3 <table border="1" style="margin-left: 20px;"> <tr><td>GNM0M2 R6 103/223/473/104</td></tr> <tr><td>GNM1M2 R6 0J 105/225</td></tr> <tr><td>GNM1M2 R6 1A 225</td></tr> <tr><td>GNM212 R6 0J 225</td></tr> <tr><td>GNM212 R6 1A 225</td></tr> <tr><td>GNM214 R6 0J 225</td></tr> </table> * ³ 然而，表3品名最大值为0.125。	GNM0M2 R6 103/223/473/104	GNM1M2 R6 0J 105/225	GNM1M2 R6 1A 225	GNM212 R6 0J 225	GNM212 R6 1A 225	GNM214 R6 0J 225	<table border="1" style="margin-left: 20px;"> <thead> <tr> <th>静电容量</th> <th>频率</th> <th>电压</th> </tr> </thead> <tbody> <tr> <td>$C \leq 10\mu\text{F}$ *¹ (最小10V)</td> <td>$1 \pm 0.1\text{kHz}$</td> <td>$1.0 \pm 0.2\text{Vrms}$</td> </tr> <tr> <td>$C \leq 10\mu\text{F}$ *² (最大6.3V)</td> <td>$1 \pm 0.1\text{kHz}$</td> <td>$0.5 \pm 0.1\text{Vrms}$</td> </tr> <tr> <td>*¹表1的项目</td> <td>$1 \pm 0.1\text{kHz}$</td> <td>$0.5 \pm 0.1\text{Vrms}$</td> </tr> <tr> <td>*²表2的项目</td> <td>$1 \pm 0.1\text{kHz}$</td> <td>$1.0 \pm 0.1\text{Vrms}$</td> </tr> </tbody> </table> Table 1 <table border="1" style="margin-left: 20px;"> <tr><td>GNM0M2 R6 1A 104</td></tr> <tr><td>GNM0M2 R6 1C 104</td></tr> <tr><td>GNM1M2 R6 1A 105/225</td></tr> <tr><td>GNM1M2 R6 1C 224/105</td></tr> </table> Table 2 <table border="1" style="margin-left: 20px;"> <tr><td>GNM0M2 R6 0J 103/223/473</td></tr> <tr><td>GNM212 R6 0J 225</td></tr> <tr><td>GNM214 R6 0J 105</td></tr> </table>	静电容量	频率	电压	$C \leq 10\mu\text{F}$ * ¹ (最小10V)	$1 \pm 0.1\text{kHz}$	$1.0 \pm 0.2\text{Vrms}$	$C \leq 10\mu\text{F}$ * ² (最大6.3V)	$1 \pm 0.1\text{kHz}$	$0.5 \pm 0.1\text{Vrms}$	* ¹ 表1的项目	$1 \pm 0.1\text{kHz}$	$0.5 \pm 0.1\text{Vrms}$	* ² 表2的项目	$1 \pm 0.1\text{kHz}$	$1.0 \pm 0.1\text{Vrms}$	GNM0M2 R6 1A 104	GNM0M2 R6 1C 104	GNM1M2 R6 1A 105/225	GNM1M2 R6 1C 224/105	GNM0M2 R6 0J 103/223/473	GNM212 R6 0J 225	GNM214 R6 0J 105		
			GNM0M2 R6 103/223/473/104																														
GNM1M2 R6 0J 105/225																																	
GNM1M2 R6 1A 225																																	
GNM212 R6 0J 225																																	
GNM212 R6 1A 225																																	
GNM214 R6 0J 225																																	
静电容量	频率	电压																															
$C \leq 10\mu\text{F}$ * ¹ (最小10V)	$1 \pm 0.1\text{kHz}$	$1.0 \pm 0.2\text{Vrms}$																															
$C \leq 10\mu\text{F}$ * ² (最大6.3V)	$1 \pm 0.1\text{kHz}$	$0.5 \pm 0.1\text{Vrms}$																															
* ¹ 表1的项目	$1 \pm 0.1\text{kHz}$	$0.5 \pm 0.1\text{Vrms}$																															
* ² 表2的项目	$1 \pm 0.1\text{kHz}$	$1.0 \pm 0.1\text{Vrms}$																															
GNM0M2 R6 1A 104																																	
GNM0M2 R6 1C 104																																	
GNM1M2 R6 1A 105/225																																	
GNM1M2 R6 1C 224/105																																	
GNM0M2 R6 0J 103/223/473																																	
GNM212 R6 0J 225																																	
GNM214 R6 0J 105																																	
9	静电容量温度特性	<table border="1" style="margin-left: 20px;"> <thead> <tr> <th>特性</th> <th>温度范围</th> <th>参考温度</th> <th>静电容量变化</th> </tr> </thead> <tbody> <tr> <td>R6</td> <td>- 55至 + 85°C</td> <td>25°C</td> <td>在 ± 15%范围内</td> </tr> </tbody> </table>	特性	温度范围	参考温度	静电容量变化	R6	- 55至 + 85°C	25°C	在 ± 15%范围内	静电容量变化应在进入规定的各温度阶段5分钟后测量。 <table border="1" style="margin-left: 20px;"> <thead> <tr> <th>阶段</th> <th>温度 (°C)</th> </tr> </thead> <tbody> <tr><td>1</td><td>25 ± 2</td></tr> <tr><td>2</td><td>- 55 ± 3</td></tr> <tr><td>3</td><td>25 ± 2</td></tr> <tr><td>4</td><td>85 ± 3</td></tr> <tr><td>5</td><td>25 ± 2</td></tr> </tbody> </table> 表中所示的温度范围内静电容量的变化较于参考温度时容量的变化都应在规定范围内。 • 高介电常数型的初次测量 在150 + 0/ - 10°C条件下进行1小时热处理，然后在常温下放置24 ± 2小时，之后进行初次测量。	阶段	温度 (°C)	1	25 ± 2	2	- 55 ± 3	3	25 ± 2	4	85 ± 3	5	25 ± 2										
特性	温度范围	参考温度	静电容量变化																														
R6	- 55至 + 85°C	25°C	在 ± 15%范围内																														
阶段	温度 (°C)																																
1	25 ± 2																																
2	- 55 ± 3																																
3	25 ± 2																																
4	85 ± 3																																
5	25 ± 2																																
10	端子结合强度	不应出现端子脱落或其它缺陷。 <div style="display: flex; justify-content: space-around; align-items: center;"> <div style="text-align: center;">  <p>GNM□□4</p> </div> <div style="text-align: center;">  <p>GNM□□2</p> </div> </div> <p style="text-align: center;">图1</p>	使用共晶锡将电容器焊接在图1中所示的测试夹具 (玻璃环氧树脂板) 上。 然后平行于测试夹具施加5N (GNM0M2: 2N) 的力 10 ± 1 秒。 焊接应利用烙铁或使用回流焊接方式进行，而且应谨慎作业，以使焊接均匀且不会由于热冲击产生缺陷。 <table border="1" style="margin-left: 20px;"> <thead> <tr> <th>型号</th> <th>a</th> <th>b</th> <th>c</th> <th>d</th> </tr> </thead> <tbody> <tr><td>GNM0M2</td><td>0.2</td><td>0.96</td><td>0.25</td><td>0.2</td></tr> <tr><td>GNM1M2</td><td>0.5</td><td>1.6</td><td>0.32</td><td>0.32</td></tr> <tr><td>GNM212</td><td>0.6</td><td>1.8</td><td>0.5</td><td>0.5</td></tr> <tr><td>GNM214</td><td>0.6</td><td>2.0</td><td>0.25</td><td>0.25</td></tr> <tr><td>GNM314</td><td>0.8</td><td>2.5</td><td>0.4</td><td>0.4</td></tr> </tbody> </table> <p style="text-align: right;">(in mm)</p>	型号	a	b	c	d	GNM0M2	0.2	0.96	0.25	0.2	GNM1M2	0.5	1.6	0.32	0.32	GNM212	0.6	1.8	0.5	0.5	GNM214	0.6	2.0	0.25	0.25	GNM314	0.8	2.5	0.4	0.4
型号	a	b	c	d																													
GNM0M2	0.2	0.96	0.25	0.2																													
GNM1M2	0.5	1.6	0.32	0.32																													
GNM212	0.6	1.8	0.5	0.5																													
GNM214	0.6	2.0	0.25	0.25																													
GNM314	0.8	2.5	0.4	0.4																													
11	外观	无缺陷或异常	按照与(10)相同的方法和条件，将电容器焊接在测试夹具(玻璃环氧树脂板)上。 电容器应进行简谐运动，其总幅值为1.5mm，频率在近似10至55Hz之间均匀变化。频率范围(从10至55Hz再返回10Hz)应在约1分钟内完成。 振动应在3个相互垂直方向各进行2小时(总计6小时)。																														
	静电容量	在规定偏差范围内																															
	D.F.	最大0.1* ³ * ³ 然而，表3品名最大值为0.125。																															

接下一页。

GNM系列规格和测试方法 (2)

☐ 接上页。

当品名表中未附有“*”时，请参见GNM系列规格和测试方法(1)。
 当品名表中附有“*”时，请参见GNM系列规格和测试方法(2)。

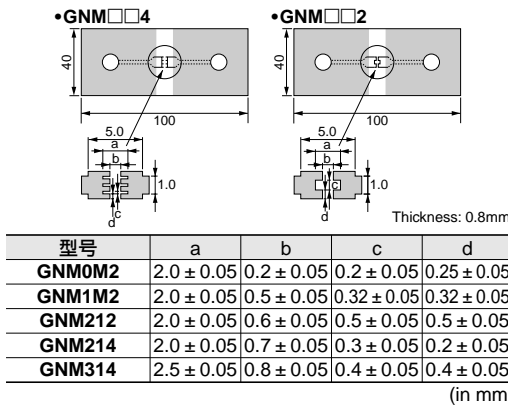
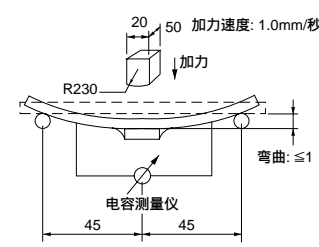
编号	项目	特性	测试方法																														
12	外观	无明显缺陷	使用共晶锡将电容器焊接在图2中所示的测试夹具(玻璃环氧树脂板)上。然后在图3所示的方向加力。焊接应使用回流焊接方法进行，而且应谨慎作业，以使焊接均匀且不会由于热冲击产生缺陷。																														
	静电容量变化	在±10%范围内																															
12	弯曲强度	 <table border="1" data-bbox="367 593 877 772"> <thead> <tr> <th>型号</th> <th>a</th> <th>b</th> <th>c</th> <th>d</th> </tr> </thead> <tbody> <tr> <td>GNM0M2</td> <td>2.0 ± 0.05</td> <td>0.2 ± 0.05</td> <td>0.2 ± 0.05</td> <td>0.25 ± 0.05</td> </tr> <tr> <td>GNM1M2</td> <td>2.0 ± 0.05</td> <td>0.5 ± 0.05</td> <td>0.32 ± 0.05</td> <td>0.32 ± 0.05</td> </tr> <tr> <td>GNM212</td> <td>2.0 ± 0.05</td> <td>0.6 ± 0.05</td> <td>0.5 ± 0.05</td> <td>0.5 ± 0.05</td> </tr> <tr> <td>GNM214</td> <td>2.0 ± 0.05</td> <td>0.7 ± 0.05</td> <td>0.3 ± 0.05</td> <td>0.2 ± 0.05</td> </tr> <tr> <td>GNM314</td> <td>2.5 ± 0.05</td> <td>0.8 ± 0.05</td> <td>0.4 ± 0.05</td> <td>0.4 ± 0.05</td> </tr> </tbody> </table> <p style="text-align: center;">图2</p>	型号	a	b	c	d	GNM0M2	2.0 ± 0.05	0.2 ± 0.05	0.2 ± 0.05	0.25 ± 0.05	GNM1M2	2.0 ± 0.05	0.5 ± 0.05	0.32 ± 0.05	0.32 ± 0.05	GNM212	2.0 ± 0.05	0.6 ± 0.05	0.5 ± 0.05	0.5 ± 0.05	GNM214	2.0 ± 0.05	0.7 ± 0.05	0.3 ± 0.05	0.2 ± 0.05	GNM314	2.5 ± 0.05	0.8 ± 0.05	0.4 ± 0.05	0.4 ± 0.05	 <p style="text-align: center;">图3</p>
	型号	a	b	c	d																												
GNM0M2	2.0 ± 0.05	0.2 ± 0.05	0.2 ± 0.05	0.25 ± 0.05																													
GNM1M2	2.0 ± 0.05	0.5 ± 0.05	0.32 ± 0.05	0.32 ± 0.05																													
GNM212	2.0 ± 0.05	0.6 ± 0.05	0.5 ± 0.05	0.5 ± 0.05																													
GNM214	2.0 ± 0.05	0.7 ± 0.05	0.3 ± 0.05	0.2 ± 0.05																													
GNM314	2.5 ± 0.05	0.8 ± 0.05	0.4 ± 0.05	0.4 ± 0.05																													
13	端子可焊性	75%端子需均匀且连续焊接。	将电容器浸泡在乙醇(JIS-K-8101)和松香(JIS-K-5902)(松香占25%的重量)溶液中。在80至120°C范围内预热10至30秒。预热后，再浸泡在230 ± 5°C的共晶锡溶液2 ± 0.5秒或在245 ± 5°C的Sn-3.0Ag-0.5Cu无铅焊锡溶液2 ± 0.5秒。																														
14	外观	无明显缺陷	在120至150°C范围内预热电容器1分钟。 将电容器浸泡在270 ± 5°C的共晶锡溶液或Sn-3.0Ag-0.5Cu无铅焊锡溶液10 ± 0.5秒。在常温下放置24 ± 2小时，然后进行测量。 • 初次测量 在150 + 0/ - 10°C条件下进行1小时热处理，然后在常温下放置24 ± 2小时。之后进行初次测量。																														
	静电容量变化	R6 ⁴ : 在±7.5%范围内 *4GNM0M2R60E105: 在+15/ - 7.5%范围内																															
	D.F.	最大0.1 ^{*3} *3然而，表3品名最大值为0.125。																															
	绝缘电阻	最小50Ω · F																															
	介电强度	无失效																															
15	外观	无明显缺陷	按照与(10)相同的方法和条件，将电容器固定在支撑夹具上。按照下表中列出的4种热处理方法执行5个周期。在常温下放置24 ± 2小时，然后进行测量。 <table border="1" data-bbox="925 1220 1452 1310"> <thead> <tr> <th>阶段</th> <th>1</th> <th>2</th> <th>3</th> <th>4</th> </tr> </thead> <tbody> <tr> <td>温度(°C)</td> <td>最低动作温度</td> <td>常温</td> <td>最低动作温度</td> <td>常温</td> </tr> <tr> <td>时间(分钟)</td> <td>30 ± 3</td> <td>2至3</td> <td>30 ± 3</td> <td>2至3</td> </tr> </tbody> </table> • 初次测量 在150 + 0/ - 10°C条件下进行1小时热处理，然后在常温下放置24 ± 2小时后进行测量。之后进行初次测量。	阶段	1	2	3	4	温度(°C)	最低动作温度	常温	最低动作温度	常温	时间(分钟)	30 ± 3	2至3	30 ± 3	2至3															
	阶段	1		2	3	4																											
	温度(°C)	最低动作温度		常温	最低动作温度	常温																											
	时间(分钟)	30 ± 3		2至3	30 ± 3	2至3																											
	静电容量变化	R6 ⁵ : 在±12.5%范围内 *5GNM0M2R60E105: 在±15%范围内																															
D.F.	最大0.1 ^{*3} *3然而，表3品名最大值为0.125。																																
绝缘电阻	最小50Ω · F																																
介电强度	无失效																																
16	外观	无明显缺陷	在40 ± 2°C及90至95%湿度条件下施加额定电压500 ± 12小时。充电/放电电流低于50mA。 • 初次测量 在150 + 0/ - 10°C条件下进行1小时热处理，然后在常温下放置24 ± 2小时。之后进行测量。 • 测试后测量 在150 + 0/ - 10°C条件下进行1小时热处理，然后在常温下放置24 ± 2小时。之后进行测量。																														
	静电容量变化	R6: 在±12.5%范围内																															
	D.F.	最大0.2																															
17	外观	无明显缺陷	在最高工作温度 ± 3°C条件下施加150%额定电压(GNM1M2R61A225/1C105: 125%额定电压) 1000 ± 12小时。在常温下放置24 ± 2小时，然后进行测量。充电/放电电流低于50mA。 • 初次测量 在150 + 0/ - 10°C条件下进行1小时热处理，然后在常温下放置24 ± 2小时。之后进行测量。 • 测试后测量 在150 + 0/ - 10°C条件下进行1小时热处理，然后在常温下放置24 ± 2小时。之后进行测量。																														
	静电容量变化	R6: 在±12.5%范围内																															
	D.F.	最大0.2																															
	绝缘电阻	最小25Ω · F																															

片状独石陶瓷电容器



低ESL型 LLL/LLA/LLM系列

宽幅低ESL型

特点 (宽幅低ESL型)

1. ESL低，高频时降噪效果好
2. 体积小，静电容量高

用途

1. 高速微型处理器用
2. 高频数码设备用

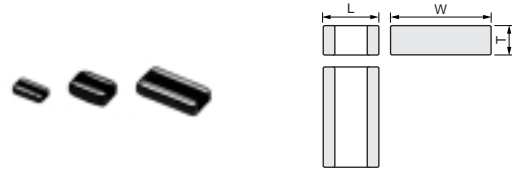

Part Number	Dimensions (mm)		
	L	W	T
LLL153	0.5 ±0.05	1.0 ±0.05	0.3 ±0.05
LLL185	0.8 ±0.1	1.6 ±0.1	0.6 max.
LLL215	1.25 ±0.1	2.0 ±0.1	0.5 +0/-0.15
LLL216			0.6 ±0.1
LLL219			0.85 ±0.1
LLL315			0.5 +0/-0.15
LLL317	1.6 ±0.15	3.2 ±0.15	0.7 ±0.1
LLL31M			1.15 ±0.1

8终端低ESL型

特点 (8终端低ESL型)

1. 低ESL (100pH)，做为去偶电容器适用于1GHz clock speed IC。
2. 体积小，静电容量高

用途

1. 高速微型处理器用
2. 高频数码设备用

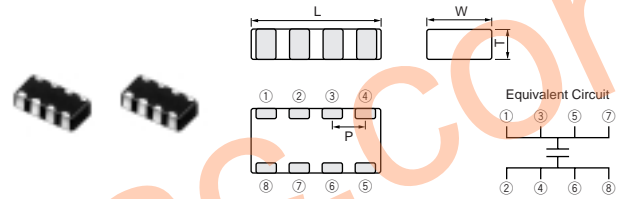

Part Number	Dimensions (mm)			
	L	W	T	P
LLA185	1.6 ±0.1	0.8 ±0.1	0.5 +0.05/-0.1	0.4 ±0.1
LLA215	2.0 ±0.1	1.25 ±0.1	0.5 +0.05/-0.1	0.5 ±0.05
LLA219	2.0 ±0.1	1.25 ±0.1	0.85 ±0.1	0.5 ±0.05
LLA315	3.2 ±0.15	1.6 ±0.15	0.5 +0.05/-0.1	0.8 ±0.1
LLA319	3.2 ±0.15	1.6 ±0.15	0.85 ±0.1	0.8 ±0.1
LLA31M	3.2 ±0.15	1.6 ±0.15	1.15 ±0.1	0.8 ±0.1

10终端低ESL型

特点 (10终端低ESL型)

1. 低ESL (45pH)，做为去偶电容器适用于2GHz clock speed IC。
2. 体积小，静电容量高

用途

1. 高速微型处理器用
2. 高频数码设备用

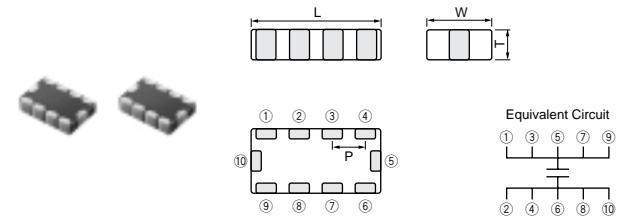

Part Number	Dimensions (mm)			
	L	W	T	P
LLM215	2.0 ±0.1	1.25 ±0.1	0.5 +0.05/-0.1	0.5 ±0.05
LLM315	3.2 ±0.15	1.6 ±0.15	0.5 +0.05/-0.1	0.8 ±0.1

电容表

宽幅低ESL型 X7R(R7)/X7S(C7)/X6S(C8)/X5R(R6) 特性

5		例) 5: 厚度 [mm]																	
长x宽 [mm]	额定电压 [Vdc]	0.5x1.0 (15) <0204>				0.8x1.6 (18) <0306>				1.25x2.0 (21) <0508>				1.6x3.2 (31) <0612>					
		6.3 (0J)	4 (0G)	50 (1H)	25 (1E)	16 (1C)	10 (1A)	4 (0G)	50 (1H)	25 (1E)	16 (1C)	10 (1A)	4 (0G)	50 (1H)	25 (1E)	16 (1C)	10 (1A)	6.3 (0J)	
静电容量	TC代号	X6S (C8)	X7S (C7)	X7R (R7)	X7R (R7)	X7R (R7)	X7R (R7)	X7S (C7)	X7R (R7)	X7R (R7)	X7R (R7)	X7R (R7)	X7S (C7)	X7R (R7)	X7R (R7)	X7R (R7)	X7R (R7)	X7R (R7)	X5R (R6)
2200pF(222)				5															
4700pF(472)				5															
10000pF(103)					5				6										
22000pF(223)					5				6										
47000pF(473)						5				6									
0.10μF(104)	3						5			6				M	7				
0.22μF(224)	3						5				9	6			M	7			
0.47μF(474)		3						5				9			M	7			
1.0μF(105)								5				9				M	7		
2.2μF(225)								5					9				M	7	
4.7μF(475)																		M	7
10μF(106)																			M

品名代号在()中注明，单位在 []中注明。< >: EIA [英寸] 代号

宽幅低ESL型 X7R(R7)/X7S(C7) 特性 薄型

5		例) 5: 厚度 [mm]													
长x宽 [mm]	额定电压 [Vdc]	0.8x1.6 (18) <0306>				1.25x2.0 (21) <0508>				1.6x3.2 (31) <0612>					
		25 (1E)	16 (1C)	10 (1A)	4 (0G)	50 (1H)	25 (1E)	16 (1C)	10 (1A)	6.3 (0J)	4 (0G)	50 (1H)	25 (1E)	16 (1C)	10 (1A)
静电容量	TC代号	X7R (R7)	X7R (R7)	X7R (R7)	X7S (C7)	X7R (R7)	X7R (R7)	X7R (R7)	X7R (R7)	X7R (R7)	X7S (C7)	X7R (R7)	X7R (R7)	X7R (R7)	X7R (R7)
10000pF(103)		5				5						5			
22000pF(223)			5				5						5		
47000pF(473)			5					5						5	
0.10μF(104)				5				5						5	
0.22μF(224)					5				5						5
0.47μF(474)										5					
1.0μF(105)											5				

品名代号在()中注明，单位在 []中注明。< >: EIA [英寸] 代号

接下页。 

接上页

8终端低ESL型 X7S(C7)/X7R(R7) 特性

5		例 5: 厚度 [mm]								
长x宽 [mm]	1.6x0.8 (18) <0603>	2.0x1.25 (21) <0805>					3.2x1.6 (31) <1206>			
	额定电压 [Vdc]	4 (0G)	25 (1E)	16 (1C)	10 (1A)	6.3 (0J)	4 (0G)	16 (1C)	10 (1A)	4 (0G)
静电容量	TC代号	X7S (C7)	X7R (R7)	X7R (R7)	X7R (R7)	X7R (R7)	X7S (C7)	X7R (R7)	X7R (R7)	X7R (R7)
	10000pF(103)			9						
22000pF(223)			9							
47000pF(473)			9							
0.10μF(104)	5		9					9		
0.22μF(224)	5		9					9		
0.47μF(474)	5				9			9		
1.0μF(105)	5					9		M	9	
2.2μF(225)	5						9		M	9
4.7μF(475)							9			

品名代号在()中注明，单位在 []中注明。< >: EIA [英寸] 代号

8终端低ESL型 X7R(R7)/X7S(C7) 特性 薄型

5		例 5: 厚度 [mm]							
长x宽 [mm]	2.0x1.25 (21) <0805>	2.0x1.25 (21) <0805>			3.2x1.6 (31) <1206>				
	额定电压 [Vdc]	25 (1E)	16 (1C)	10 (1A)	6.3 (0J)	4 (0G)	16 (1C)	10 (1A)	6.3 (0J)
静电容量	TC代号	X7R (R7)	X7R (R7)	X7R (R7)	X7R (R7)	X7S (C7)	X7R (R7)	X7R (R7)	X7R (R7)
	10000pF(103)	5							
22000pF(223)	5								
47000pF(473)		5							
0.10μF(104)		5							
0.22μF(224)			5			5			
0.47μF(474)				5			5		
1.0μF(105)					5				5
2.2μF(225)						5			5
4.7μF(475)						5			

品名代号在()中注明，单位在 []中注明。< >: EIA [英寸] 代号

10终端低ESL型 X7R(R7)/X7S(C7) 特性 薄型

5		例 5: 厚度 [mm]						
长x宽 [mm]	2.0x1.25 (21) <0805>	2.0x1.25 (21) <0805>			3.2x1.6 (31) <1206>			
	额定电压 [Vdc]	25 (1E)	16 (1C)	6.3 (0J)	4 (0G)	16 (1C)	10 (1A)	6.3 (0J)
静电容量	TC代号	X7R (R7)	X7R (R7)	X7R (R7)	X7S (C7)	X7R (R7)	X7R (R7)	X7R (R7)
	10000pF(103)	5						
22000pF(223)	5							
47000pF(473)		5						
0.10μF(104)		5				5		
0.22μF(224)			5			5		
0.47μF(474)				5			5	
1.0μF(105)					5			
2.2μF(225)							5	

品名代号在()中注明，单位在 []中注明。< >: EIA [英寸] 代号

3

宽幅低ESL型 X7R(R7)/X7S(C7)/X6S(C8) 特性

长x宽 [mm]	0.5x1.0(15)<0204>		
额定电压 [Vdc]	6.3(0J)	4(0G)	
静电容量	公差	品名	
0.10μF(104)	±20%(M)	LLL153C80J104ME01E*	
0.22μF(224)	±20%(M)	LLL153C80J224ME14E*	
0.47μF(474)	±20%(M)	LLL153C70G474ME17E*	

LLL153系列4V/0.47 μ F (L:0.5 + 0.07/ - 0.03mm)

长x宽 [mm]	0.8x1.6(18)<0306>			
额定电压 [Vdc]	50(1H)	25(1E)	16(1C)	10(1A)
静电容量	公差	品名		
2200pF(222)	±20%(M)	LLL185R71H222MA01L		
4700pF(472)	±20%(M)	LLL185R71H472MA01L		
10000pF(103)	±20%(M)		LLL185R71E103MA01L	
22000pF(223)	±20%(M)		LLL185R71E223MA01L	
47000pF(473)	±20%(M)		LLL185R71C473MA01L	
0.10μF(104)	±20%(M)			LLL185R71A104MA01L
0.22μF(224)	±20%(M)			LLL185R71A224MA01L

长x宽 [mm]	0.8x1.6(18)<0306>	
额定电压 [Vdc]	4(0G)	
静电容量	公差	品名
0.47μF(474)	±20%(M)	LLL185C70G474MA01L
1.0μF(105)	±20%(M)	LLL185C70G105ME02L*
2.2μF(225)	±20%(M)	LLL185C70G225ME01L*

长x宽 [mm]	1.25x2.0(21)<0508>			
额定电压 [Vdc]	50(1H)	25(1E)	16(1C)	10(1A)
静电容量	公差	品名		
10000pF(103)	±20%(M)	LLL216R71H103MA01L		
22000pF(223)	±20%(M)	LLL216R71H223MA01L		
47000pF(473)	±20%(M)	LLL216R71E473MA01L		
0.10μF(104)	±20%(M)	LLL216R71E104MA01L		
0.22μF(224)	±20%(M)		LLL219R71C224MA01L	LLL216R71A224MA01L
0.47μF(474)	±20%(M)			LLL219R71A474MA01L
1.0μF(105)	±20%(M)			LLL219R71A105MA01L

长x宽 [mm]	1.25x2.0(21)<0508>	
额定电压 [Vdc]	4(0G)	
静电容量	公差	品名
2.2μF(225)	±20%(M)	LLL219C70G225MA01L

品名代号在()中注明，单位在 []中注明。< >: EIA [英寸] 代号
 *: 请参见LLL/LLA/LLM系列规格和测试方法 (2)。

- (品名) LL L 15 3 C8 0J 104 M E01 E ①型号 ②系列 ③尺寸(长×宽) ④尺寸(厚度) ⑤温度特性
 ⑥额定电压 ⑦静电容量 ⑧静电容量公差 ⑨个别规格代号 ⑩包装

品名中的包装代号表示标准180mm卷盘。

宽幅低ESL型 X7R(R7)/X5R(R6) 特性

长x宽 [mm]		1.6x3.2(31)<0612>			
额定电压 [Vdc]		50(1H)	25(1E)	16(1C)	10(1A)
静电容量	公差	品名			
10000pF(103)	±20%(M)	LLL317R71H103MA01L			
22000pF(223)	±20%(M)	LLL317R71H223MA01L			
47000pF(473)	±20%(M)	LLL317R71H473MA01L			
0.10μF(104)	±20%(M)	LLL31MR71H104MA01L	LLL317R71E104MA01L		
0.22μF(224)	±20%(M)		LLL31MR71E224MA01L	LLL317R71C224MA01L	
0.47μF(474)	±20%(M)		LLL31MR71E474MA01L	LLL317R71C474MA01L	
1.0μF(105)	±20%(M)			LLL31MR71C105MA01L	LLL317R71A105MA01L
2.2μF(225)	±20%(M)				LLL31MR71A225MA01L

长x宽 [mm]		1.6x3.2(31)<0612>	
额定电压 [Vdc]		6.3(0J)	
静电容量	公差	品名	
2.2μF(225)	±20%(M)	LLL317R70J225MA01L	
4.7μF(475)	±20%(M)	LLL31MR70J475MA01L	
10μF(106)	±20%(M)	LLL31MR60J106ME01L*	

品名代号在()中注明，单位在 []中注明。< >: EIA [英寸] 代号
 *: 请参见LLL/LLA/LLM系列规格和测试方法 (2)。

宽幅低ESL型 X7R(R7)/X7S(C7) 特性 薄型

长x宽 [mm]		0.8x1.6(18)<0306>			
额定电压 [Vdc]		25(1E)	16(1C)	10(1A)	4(0G)
静电容量	公差	品名			
10000pF(103)	±20%(M)	LLL185R71E103MA11L			
22000pF(223)	±20%(M)		LLL185R71C223MA11L		
47000pF(473)	±20%(M)		LLL185R71C473MA11L		
0.10μF(104)	±20%(M)			LLL185R71A104MA11L	
0.22μF(224)	±20%(M)				LLL185C70G224MA11L

长x宽 [mm]		1.25x2.0(21)<0508>			
额定电压 [Vdc]		50(1H)	25(1E)	16(1C)	10(1A)
静电容量	公差	品名			
10000pF(103)	±20%(M)	LLL215R71H103MA11L			
22000pF(223)	±20%(M)		LLL215R71E223MA11L		
47000pF(473)	±20%(M)			LLL215R71C473MA11L	
0.10μF(104)	±20%(M)			LLL215R71C104MA11L	
0.22μF(224)	±20%(M)				LLL215R71A224MA11L

长x宽 [mm]		1.25x2.0(21)<0508>	
额定电压 [Vdc]		6.3(0J)	4(0G)
静电容量	公差	品名	
0.47μF(474)	±20%(M)	LLL215R70J474MA11L	
1.0μF(105)	±20%(M)	LLL215C70G105MA11L	

品名代号在()中注明，单位在 []中注明。< >: EIA [英寸] 代号
 *: 请参见LLL/LLA/LLM系列规格和测试方法 (2)。

8终端低ESL型 X7R(R7)/X7S(C7) 特性 薄型

长x宽 [mm]		2.0x1.25(21)<0805>			
额定电压 [Vdc]		25(1E)	16(1C)	10(1A)	6.3(0J)
静电容量	公差	品名			
10000pF(103)	±20%(M)	LLA215R71E103MA14L			
22000pF(223)	±20%(M)	LLA215R71E223MA14L			
47000pF(473)	±20%(M)		LLA215R71C473MA14L		
0.10μF(104)	±20%(M)		LLA215R71C104MA14L		
0.22μF(224)	±20%(M)			LLA215R71A224MA14L	
0.47μF(474)	±20%(M)				LLA215R70J474MA14L

长x宽 [mm]		2.0x1.25(21)<0805>	
额定电压 [Vdc]		4(0G)	
静电容量	公差	品名	
1.0μF(105)	±20%(M)	LLA215C70G105MA14L	
2.2μF(225)	±20%(M)	LLA215C70G225ME11L*	
4.7μF(475)	±20%(M)	LLA215C70G475ME19L*	

长x宽 [mm]		3.2x1.6(31)<1206>		
额定电压 [Vdc]		16(1C)	10(1A)	6.3(0J)
静电容量	公差	品名		
0.22μF(224)	±20%(M)	LLA315R71C224MA14L		
0.47μF(474)	±20%(M)		LLA315R71A474MA14L	
1.0μF(105)	±20%(M)			LLA315R70J105MA14L
2.2μF(225)	±20%(M)			LLA315R70J225MA14L

品名代号在()中注明，单位在 []中注明。<>: EIA [英寸] 代号
 *: 请参见LLL/LLA/LLM系列规格和测试方法 (2)。

10终端低ESL型 X7R(R7)/X7S(C7) 特性 薄型

长x宽 [mm]		2.0x1.25(21)<0805>			
额定电压 [Vdc]		25(1E)	16(1C)	6.3(0J)	4(0G)
静电容量	公差	品名			
10000pF(103)	±20%(M)	LLM215R71E103MA11L			
22000pF(223)	±20%(M)	LLM215R71E223MA11L			
47000pF(473)	±20%(M)		LLM215R71C473MA11L		
0.10μF(104)	±20%(M)		LLM215R71C104MA11L		
0.22μF(224)	±20%(M)			LLM215R70J224MA11L	
0.47μF(474)	±20%(M)			LLM215R70J474MA11L	
1.0μF(105)	±20%(M)				LLM215C70G105MA11L
2.2μF(225)	±20%(M)				LLM215C70G225ME11L*

长x宽 [mm]		3.2x1.6(31)<1206>		
额定电压 [Vdc]		16(1C)	10(1A)	6.3(0J)
静电容量	公差	品名		
0.10μF(104)	±20%(M)	LLM315R71C104MA11L		
0.22μF(224)	±20%(M)	LLM315R71C224MA11L		
0.47μF(474)	±20%(M)		LLM315R71A474MA11L	
2.2μF(225)	±20%(M)			LLM315R70J225MA11L

品名代号在()中注明，单位在 []中注明。<>: EIA [英寸] 代号
 *: 请参见LLL/LLA/LLM系列规格和测试方法 (2)。

LLL/LLA/LLM系列规格和测试方法 (1)

当品名表中未附有“*”时，请参见LLL/LLA/LLM系列规格和测试方法(1)。
 当品名表中附有“*”时，请参见LLL/LLA/LLM系列规格和测试方法(2)。

编号	项目	特性	测试方法																								
1	动作温度范围	R7, C7: - 55至 + 125°C																									
2	额定电压	参见上页	额定电压定义为可向电容器连续施加的最大电压。 当交流电压附加于直流电压时， V^{P-P} 或 V^{O-P} (以较大者为准) 应维持在额定电压范围内。																								
3	外观	无缺陷或异常	目视检查																								
4	尺寸	在规定尺寸范围内	使用游标卡尺																								
5	介电强度	无缺陷或异常	在端子间施加250%额定电压1至5秒时不应观察到任何故障，并且充电/放电电流低于50mA。																								
6	绝缘电阻 (I.R.)	$C \leq 0.047\mu\text{F}$: 大于10,000MΩ $C > 0.047\mu\text{F}$: 大于500Ω · F C: 标称静容量	绝缘电阻应在25°C且最大相对湿度为75%条件下用不超过额定电压的直流电压测量，时间应选在充电开始后2分钟内。																								
7	静容量	在规定偏差范围内	静容量/Q/D.F.值应在25°C条件下，按表内的频率及电压测量。 频率: $1 \pm 0.1\text{kHz}$ 电压: $1 \pm 0.2\text{Vrms}$ *对于LLA185C70G474，静容量应在 $0.5 \pm 0.1\text{Vrms}$ 的电压下进行测量。																								
8	散逸因数 (D.F.)	W.V.: 最小25V; 最大0.025 W.V.: 最大16V/10V; 最大0.035 W.V.: 最大6.3V; 最大0.05																									
9	静容量温度特性	<table border="1"> <thead> <tr> <th>特性</th> <th>温度范围 (°C)</th> <th>参考温度</th> <th>静容量变化</th> </tr> </thead> <tbody> <tr> <td>R7</td> <td>- 55至 + 125</td> <td>25°C</td> <td>在 ± 15%范围内</td> </tr> <tr> <td>C7</td> <td>- 55至 + 125</td> <td>25°C</td> <td>在 ± 22%范围内</td> </tr> </tbody> </table>	特性	温度范围 (°C)	参考温度	静容量变化	R7	- 55至 + 125	25°C	在 ± 15%范围内	C7	- 55至 + 125	25°C	在 ± 22%范围内	静容量变化应在进入规定的各温度阶段5分钟后测量。 <table border="1"> <thead> <tr> <th>阶段</th> <th>温度 (°C)</th> </tr> </thead> <tbody> <tr> <td>1</td> <td>25 ± 2</td> </tr> <tr> <td>2</td> <td>- 55 ± 3</td> </tr> <tr> <td>3</td> <td>25 ± 2</td> </tr> <tr> <td>4</td> <td>125 ± 3</td> </tr> <tr> <td>5</td> <td>25 ± 2</td> </tr> </tbody> </table> 表中所示的温度范围内静容量的变化较于参考温度时容量的变化都应在规定范围内。 • 高介电常数型的初次测量 在150 + 0/ - 10°C条件下进行1小时热处理，再在常温下放置24 ± 2小时。 之后进行初次测量	阶段	温度 (°C)	1	25 ± 2	2	- 55 ± 3	3	25 ± 2	4	125 ± 3	5	25 ± 2
特性	温度范围 (°C)	参考温度	静容量变化																								
R7	- 55至 + 125	25°C	在 ± 15%范围内																								
C7	- 55至 + 125	25°C	在 ± 22%范围内																								
阶段	温度 (°C)																										
1	25 ± 2																										
2	- 55 ± 3																										
3	25 ± 2																										
4	125 ± 3																										
5	25 ± 2																										
10	端子结合强度	不应出现端子脱落或其它缺陷。	使用共晶锡将电容器焊接在测试夹具(玻璃环氧树脂板)上。然后平行于测试夹具施加10N*的力10 ± 1秒。 焊接应利用烙铁或使用回流焊接方式进行，而且应谨慎作业，以使焊接均匀且不会由于热冲击产生缺陷。 *LLL18及LLA/LLM系列: 5N																								
11	振荡电阻	外观: 无缺陷或异常 静容量: 在规定偏差范围内 D.F.: W.V.: 最小25V; 最大0.025 W.V.: 最大16V/10V; 最大0.035 W.V.: 最大6.3V; 最大0.05	按照与(10)相同的方法和条件，将电容器焊接在测试夹具(玻璃环氧树脂板)上。 电容器应进行简谐运动，其总幅值为1.5mm，频率在近似10至55Hz之间均匀变化。频率范围(从10至55Hz再返回10Hz)应在约1分钟内完成。 振动应在3个相互垂直方向各进行2小时(总计6小时)。																								
12	端子可焊性	75%端子需均匀且连续焊接。	将电容器浸泡在乙醇(JIS-K-8101)和松香(JIS-K-5902)(松香占25%的重量)溶液中。 在80至120°C范围内预热10至30秒。 预热后，再浸泡在230 ± 5°C的共晶锡溶液2 ± 0.5秒或在245 ± 5°C的Sn-3.0Ag-0.5Cu无铅焊锡溶液2 ± 0.5秒。																								
13	耐焊热性	外观: 无缺陷或异常 静容量变化: 在 ± 7.5%范围内 D.F.: W.V.: 最小25V; 最大0.025 W.V.: 最大16V/10V; 最大0.035 W.V.: 最大6.3V; 最大0.05 绝缘电阻: 大于10,000MΩ或500Ω · F (以较小者为准) 介电强度: 无失效	在120°C至150°C范围内预热电容器1分钟。 将电容器浸泡在270 ± 5°C的共晶锡溶液或Sn-3.0Ag-0.5Cu无铅焊锡溶液10 ± 0.5秒。在常温下放置24 ± 2小时，然后进行测量。 • 高介电常数型的初次测量 在150 + 0/ - 10°C条件下进行1小时热处理，再在常温下放置24 ± 2小时。 之后进行初次测量																								
14	温度周期	外观: 无缺陷或异常 静容量变化: 在 ± 7.5%范围内 D.F.: W.V.: 最小25V; 最大0.025 W.V.: 最大16V/10V; 最大0.035 W.V.: 最大6.3V; 最大0.05 绝缘电阻: 大于10,000MΩ或500Ω · F (以较小者为准) 介电强度: 无失效	按照与(10)相同的方法和条件，将电容器固定在支撑夹具上。 按照下表中列出的4种热处理方法执行5个周期。在常温下放置24 ± 2小时，然后进行测量。 <table border="1"> <thead> <tr> <th>阶段</th> <th>1</th> <th>2</th> <th>3</th> <th>4</th> </tr> </thead> <tbody> <tr> <td>温度 (°C)</td> <td>最低动作温度 + 0/ - 3</td> <td>常温</td> <td>最高动作温度 + 3/ - 0</td> <td>常温</td> </tr> <tr> <td>时间 (分钟)</td> <td>30 ± 3</td> <td>2至3</td> <td>30 ± 3</td> <td>2至3</td> </tr> </tbody> </table> • 初次测量 在150 + 0/ - 10°C条件下进行1小时热处理，再在常温下放置24 ± 2小时。之后进行初次测量。	阶段	1	2	3	4	温度 (°C)	最低动作温度 + 0/ - 3	常温	最高动作温度 + 3/ - 0	常温	时间 (分钟)	30 ± 3	2至3	30 ± 3	2至3									
阶段	1	2	3	4																							
温度 (°C)	最低动作温度 + 0/ - 3	常温	最高动作温度 + 3/ - 0	常温																							
时间 (分钟)	30 ± 3	2至3	30 ± 3	2至3																							

接下页。 

LLL/LLA/LLM系列规格和测试方法 (1)

☐ 接上页。

当品名表中未附有“*”时，请参见LLL/LLA/LLM系列规格和测试方法 (1)。
 当品名表中附有“*”时，请参见LLL/LLA/LLM系列规格和测试方法 (2)。

编号	项目	特性	测试方法
15	湿度 (稳态)	外观	无缺陷或异常
		静电容量 变化	在 ± 12.5% 范围内
		D.F.	W.V.: 最小10V; 最大0.05 W.V.: 最大6.3V; 最大0.075
		绝缘电阻	大于1,000MΩ或50Ω·F (以较小者为准)
			将电容器在40 ± 2°C及湿度为90至95%条件下放置500 ± 12小时。 撤到常温下放置24 ± 2小时，然后进行测量。
16	湿度负荷	外观	无缺陷或异常
		静电容量 变化	在 ± 12.5% 范围内
		D.F.	W.V.: 最小10V; 最大0.05 W.V.: 最大6.3V; 最大0.075
		绝缘电阻	大于500MΩ或25Ω·F (以较小者为准)
			在40 ± 2°C及90至95%湿度条件下施加额定电压500 ± 12小时。 撤到常温下放置24 ± 2小时，然后进行测量。 充电/放电电流低于50mA。
17	高温负荷	外观	无缺陷或异常
		静电容量 变化	在 ± 12.5% 范围内
		D.F.	W.V.: 最小10V; 最大0.05 W.V.: 最大6.3V; 最大0.075
		绝缘电阻	大于1,000MΩ或50Ω·F (以较小者为准)
			在最高动作温度 ± 3°C条件下施加200%额定电压1,000 ± 12小时。 撤到常温下放置24 ± 2小时，然后进行测量。 充电/放电电流低于50mA。 • 初次测量 在最高动作温度 ± 3°C条件下施加200% 直流额定电压1小时。 撤到常温下放置24 ± 2小时。 之后进行初次测量。

www.tocosc.com

LLL/LLA/LLM系列规格和测试方法 (2)

当品名表中未附有“*”时，请参见LLL/LLA/LLM系列规格和测试方法(1)。
当品名表中附有“*”时，请参见LLL/LLA/LLM系列规格和测试方法(2)。

编号	项目	特性	测试方法																	
1	动作温度范围	R6: - 55至 + 85°C R7, C7: - 55至 + 125°C C8: - 55至 + 105°C																		
2	额定电压	参见上页	额定电压定义为可向电容器连续施加的最大电压。 当交流电压附加于直流电压时，V ^{P-P} 或V ^{O-P} (以较大者为准) 应维持在额定电压范围内。																	
3	外观	无缺陷或异常	目视检查																	
4	尺寸	在规定尺寸范围内	使用游标卡尺																	
5	介电强度	无缺陷或异常	在端子间施加250%额定电压1至5秒时不应观察到任何故障，并且充电/放电电流低于50mA。																	
6	绝缘电阻 (I.R.)	最小50Ω · F	绝缘电阻应在25°C且最大相对湿度为75%条件下用不超过额定电压的直流电压测量，时间应选在充电开始后1分钟内。																	
7	静电容量	在规定偏差范围内	静电容量/Q/D.F.值应在25 °C条件下，按表内的频率及电压测量。																	
8	散逸因数 (D.F.)	R6, R7, C7, C8: 最大0.120	<table border="1"> <thead> <tr> <th>静电容量</th> <th>频率</th> <th>电压</th> </tr> </thead> <tbody> <tr> <td>C ≤ 10μF (最小10V)</td> <td>1 ± 0.1kHz</td> <td>1.0 ± 0.2Vrms</td> </tr> <tr> <td>C ≤ 10μF (最大6.3V)</td> <td>1 ± 0.1kHz</td> <td>0.5 ± 0.1Vrms</td> </tr> <tr> <td>C > 10μF</td> <td>120 ± 24Hz</td> <td>0.5 ± 0.1Vrms</td> </tr> </tbody> </table>	静电容量	频率	电压	C ≤ 10μF (最小10V)	1 ± 0.1kHz	1.0 ± 0.2Vrms	C ≤ 10μF (最大6.3V)	1 ± 0.1kHz	0.5 ± 0.1Vrms	C > 10μF	120 ± 24Hz	0.5 ± 0.1Vrms					
静电容量	频率	电压																		
C ≤ 10μF (最小10V)	1 ± 0.1kHz	1.0 ± 0.2Vrms																		
C ≤ 10μF (最大6.3V)	1 ± 0.1kHz	0.5 ± 0.1Vrms																		
C > 10μF	120 ± 24Hz	0.5 ± 0.1Vrms																		
9	静电容量温度特性	<table border="1"> <thead> <tr> <th>特性</th> <th>温度范围 (°C)</th> <th>参考温度</th> <th>静电容量变化</th> </tr> </thead> <tbody> <tr> <td>R6</td> <td>- 55至 + 85</td> <td rowspan="4">25°C</td> <td>在 ± 15%范围内</td> </tr> <tr> <td>R7</td> <td>- 55至 + 125</td> <td>在 ± 15%范围内</td> </tr> <tr> <td>C7</td> <td>- 55至 + 125</td> <td>在 ± 22%范围内</td> </tr> <tr> <td>C8</td> <td>- 55至 + 105</td> <td>在 ± 22%范围内</td> </tr> </tbody> </table>	特性	温度范围 (°C)	参考温度	静电容量变化	R6	- 55至 + 85	25°C	在 ± 15%范围内	R7	- 55至 + 125	在 ± 15%范围内	C7	- 55至 + 125	在 ± 22%范围内	C8	- 55至 + 105	在 ± 22%范围内	<p>静电容量变化应在进入规定的各温度阶段5分钟后测量。 表中所示的温度范围内静电容量的变化较于参考温度时容量的变化都应在规定范围内。</p> <ul style="list-style-type: none"> 高介电常数型的初次测量 在150 + 0/ - 10°C条件下进行1小时热处理，再在常温下放置24 ± 2小时。 之后进行初次测量
特性	温度范围 (°C)	参考温度	静电容量变化																	
R6	- 55至 + 85	25°C	在 ± 15%范围内																	
R7	- 55至 + 125		在 ± 15%范围内																	
C7	- 55至 + 125		在 ± 22%范围内																	
C8	- 55至 + 105		在 ± 22%范围内																	
10	端子结合强度	不应出现端子脱落或其它缺陷	<p>使用共晶锡将电容器焊接在测试夹具 (玻璃环氧树脂板) 上。然后平行于测试夹具施加10N[°]的力10 ± 1秒。 焊接应利用烙铁或使用回流焊接方式进行，而且应谨慎作业，以使焊接均匀且不会由于热冲击产生缺陷。 *5N (LLL15, LLL18, LLA, LLM系列)</p>																	
11	外观	无缺陷或异常	<p>按照与 (10) 相同的方法和条件，将电容器焊接在测试夹具 (玻璃环氧树脂板) 上。 电容器应进行简谐运动，其总幅值为1.5mm，频率在近似10至55Hz之间均匀变化。频率范围 (从10至55Hz再返回10Hz) 应在约1分钟内完成。 振动应在3个相互垂直方向各进行2小时 (总计6小时)。</p>																	
	静电容量	在规定偏差范围内																		
	D.F.	R6, R7, C7, C8: 最大0.120																		
12	端子可焊性	75%端子需均匀且连续焊接。	<p>将电容器浸泡在乙醇 (JIS-K-8101) 和松香 (JIS-K-5902) (松香占25%的重量) 溶液中。 在80至120°C范围内预热10至30秒。 预热后，再浸泡在230 ± 5°C的共晶锡溶液2 ± 0.5秒或在245 ± 5°C的Sn-3.0Ag-0.5Cu无铅焊锡溶液2 ± 0.5秒。</p>																	
13	外观	无缺陷或异常	<p>在120°C至150°C范围内预热电容器1分钟。 将电容器浸泡在270 ± 5°C的共晶锡溶液或Sn-3.0Ag-0.5Cu无铅焊锡溶液10 ± 0.5秒。在常温下放置24 ± 2小时，然后进行测量。</p> <ul style="list-style-type: none"> 高介电常数型的初次测量 在150 + 0/ - 10°C条件下进行1小时热处理，再在常温下放置24 ± 2小时。 之后进行初次测量 																	
	静电容量变化	R6, R7, C7, C8: 在 ± 7.5%范围内																		
	D.F.	R6, R7, C7, C8: 最大0.120																		
	绝缘电阻	最小50Ω · F																		
	介电强度	无失效																		
14	外观	无缺陷或异常	<p>按照与 (10) 相同的方法和条件，将电容器固定在支撑夹具上。按照下表中列出的4种热处理方法执行5个周期。在常温下放置24 ± 2小时，然后进行测量。</p> <table border="1"> <thead> <tr> <th>阶段</th> <th>1</th> <th>2</th> <th>3</th> <th>4</th> </tr> </thead> <tbody> <tr> <td>温度 (°C)</td> <td>最低动作温度 + 0/ - 3</td> <td>常温</td> <td>最低动作温度 + 0/ - 3</td> <td>常温</td> </tr> <tr> <td>时间 (分钟)</td> <td>30 ± 3</td> <td>2至3</td> <td>30 ± 3</td> <td>2至3</td> </tr> </tbody> </table> <ul style="list-style-type: none"> 初次测量 在150 + 0/ - 10°C条件下进行1小时热处理，再在常温下放置24 ± 2小时。之后进行初次测量。 	阶段	1	2	3	4	温度 (°C)	最低动作温度 + 0/ - 3	常温	最低动作温度 + 0/ - 3	常温	时间 (分钟)	30 ± 3	2至3	30 ± 3	2至3		
	阶段	1		2	3	4														
	温度 (°C)	最低动作温度 + 0/ - 3		常温	最低动作温度 + 0/ - 3	常温														
	时间 (分钟)	30 ± 3		2至3	30 ± 3	2至3														
	静电容量变化	R6, R7, C7, C8: 在 ± 12.5%范围内																		
D.F.	R6, R7, C7, C8: 最大0.120																			
绝缘电阻	最小50Ω · F																			
介电强度	无失效																			

接下页。 

LLL/LLA/LLM系列规格和测试方法 (2)

接上页。

当品名表中未附有“*”时，请参见LLL/LLA/LLM系列规格和测试方法 (1)。
 当品名表中附有“*”时，请参见LLL/LLA/LLM系列规格和测试方法 (2)。

编号	项目	特性	测试方法
15	高温高湿 (稳态)	外观	无缺陷或异常
		静电容量 变化	R6, R7, C7, C8: 在 $\pm 12.5\%$ 范围内
		D.F.	R6, R7, C7, C8: 最大0.2
		绝缘电阻	最小 $12.5\Omega \cdot F$
16	耐久性	外观	无缺陷或异常
		静电容量 变化	R6, R7, C7, C8: 在 $\pm 12.5\%$ 范围内 * LLL153C70G474: 在 $\pm 20\%$ 范围内
		D.F.	R6, R7, C7, C8: 最大0.2
		绝缘电阻	最小 $25\Omega \cdot F$

在 $40 \pm 2^\circ\text{C}$ 及 90 至 95% 相对湿度条件下施加额定电压 500 ± 12 小时。
 充电/放电电流低于 50mA。
 施加额定直流电压。
 • 初次测量
 在 $150 + 0 / - 10^\circ\text{C}$ 条件下进行 1 小时热处理，然后在常温下放置 24 ± 2 小时。之后进行初次测量。
 • 测试后测量
 在 $150 + 0 / - 10^\circ\text{C}$ 条件下进行 1 小时热处理，然后进行测量。

在最高工作温度 $\pm 3^\circ\text{C}$ 条件下施加 150% 额定电压 1000 ± 12 小时。
 充电/放电电流低于 50mA。
 • 初次测量
 在 $150 + 0 / - 10^\circ\text{C}$ 条件下进行 1 小时热处理，然后在常温下放置 24 ± 2 小时。之后进行初次测量。
 • 测试后测量
 在 $150 + 0 / - 10^\circ\text{C}$ 条件下进行 1 小时热处理后，在常温下放置 24 ± 2 小时，然后进行测量。

www.tocosc.com

片状独石陶瓷电容器



高Q值型 GJM系列

特点

1. 主要用于移动通信与射频组件。
2. 改善通话质量，降低功耗，提高屈服比。

用途

微波振荡器 (VCO)、功率放大器 (PA)、移动通信用

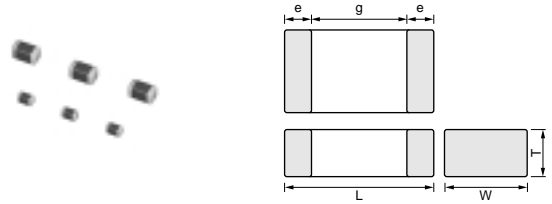

Part Number	Dimensions (mm)				
	L	W	T	e	g min.
GJM03	0.6 ±0.03	0.3 ±0.03	0.3 ±0.03	0.1 to 0.2	0.2
GJM15	1.0 ±0.05	0.5 ±0.05	0.5 ±0.05	0.15 to 0.3	0.4

4

www.tocosc.com

电容表

温度补偿型 C0G(5C)/C0H(6C) 特性

3 例3: 厚度 [mm]			
长x宽 [mm]	0.6x0.3 (03) <0201>		1.0x0.5 (15) <0402>
	额定电压 [Vdc]		50 (1H)
静电容量	25 (1A)	6.3 (0J)	50 (1H)
0.1pF(R10)			5
0.2pF(R20)	3		5
0.3pF(R30)	3		5
0.4pF(R40)	3		5
0.5pF(R50)	3		5
0.6pF(R60)	3		5
0.7pF(R70)	3		5
0.8pF(R80)	3		5
0.9pF(R90)	3		5
1.0pF(1R0)	3		5
1.1pF(1R1)	3		5
1.2pF(1R2)	3		5
1.3pF(1R3)	3		5
1.4pF(1R4)	3		5
1.5pF(1R5)	3		5
1.6pF(1R6)	3		5
1.7pF(1R7)	3		5
1.8pF(1R8)	3		5
1.9pF(1R9)	3		5
2.0pF(2R0)	3		5
2.1pF(2R1)	3		5
2.2pF(2R2)	3		5
2.3pF(2R3)	3		5
2.4pF(2R4)	3		5
2.5pF(2R5)	3		5
2.6pF(2R6)	3		5
2.7pF(2R7)	3		5
2.8pF(2R8)	3		5
2.9pF(2R9)	3		5
3.0pF(3R0)	3		5
3.1pF(3R1)	3		5
3.2pF(3R2)	3		5
3.3pF(3R3)	3		5
3.4pF(3R4)	3		5
3.5pF(3R5)	3		5
3.6pF(3R6)	3		5
3.7pF(3R7)	3		5
3.8pF(3R8)	3		5
3.9pF(3R9)	3		5
4.0pF(4R0)	3		5
4.1pF(4R1)	3		5
4.2pF(4R2)	3		5
4.3pF(4R3)	3		5
4.4pF(4R4)	3		5
4.5pF(4R5)	3		5
4.6pF(4R6)	3		5
4.7pF(4R7)	3		5
4.8pF(4R8)	3		5
4.9pF(4R9)	3		5

长x宽 [mm]	0.6x0.3 (03) <0201>		1.0x0.5 (15) <0402>
	额定电压 [Vdc]		50 (1H)
静电容量	25 (1A)	6.3 (0J)	50 (1H)
5.0pF(5R0)	3		5
5.1pF(5R1)	3		5
5.2pF(5R2)	3		5
5.3pF(5R3)	3		5
5.4pF(5R4)	3		5
5.5pF(5R5)	3		5
5.6pF(5R6)	3		5
5.7pF(5R7)	3		5
5.8pF(5R8)	3		5
5.9pF(5R9)	3		5
6.0pF(6R0)	3		5
6.1pF(6R1)	3		5
6.2pF(6R2)	3		5
6.3pF(6R3)	3		5
6.4pF(6R4)	3		5
6.5pF(6R5)	3		5
6.6pF(6R6)	3		5
6.7pF(6R7)	3		5
6.8pF(6R8)	3		5
6.9pF(6R9)	3		5
7.0pF(7R0)	3		5
7.1pF(7R1)	3		5
7.2pF(7R2)	3		5
7.3pF(7R3)	3		5
7.4pF(7R4)	3		5
7.5pF(7R5)	3		5
7.6pF(7R6)	3		5
7.7pF(7R7)	3		5
7.8pF(7R8)	3		5
7.9pF(7R9)	3		5
8.0pF(8R0)	3		5
8.1pF(8R1)	3		5
8.2pF(8R2)	3		5
8.3pF(8R3)	3		5
8.4pF(8R4)	3		5
8.5pF(8R5)	3		5
8.6pF(8R6)	3		5
8.7pF(8R7)	3		5
8.8pF(8R8)	3		5
8.9pF(8R9)	3		5
9.0pF(9R0)	3		5
9.1pF(9R1)	3		5
9.2pF(9R2)	3		5
9.3pF(9R3)	3		5
9.4pF(9R4)	3		5
9.5pF(9R5)	3		5
9.6pF(9R6)	3		5
9.7pF(9R7)	3		5
9.8pF(9R8)	3		5

长x宽 [mm]	0.6x0.3 (03) <0201>		1.0x0.5 (15) <0402>
	额定电压 [Vdc]		50 (1H)
静电容量	25 (1A)	6.3 (0J)	50 (1H)
9.9pF(9R9)	3		5
10pF(100)	3		5
11pF(110)	3		5
12pF(120)	3		5
13pF(130)	3		5
15pF(150)	3		5
16pF(160)	3		5
18pF(180)	3		5
20pF(200)	3		5
22pF(220)		3	
24pF(240)		3	
27pF(270)		3	
30pF(300)		3	
33pF(330)		3	

4

品名代号在()中注明，单位在 []中注明。< >: EIA [英寸] 代号

温度补偿型 C0G(5C) 特性

长x宽 [mm]		0.6x0.3(03)<0201>	1.0x0.5(15)<0402>
额定电压 [Vdc]		25(1E)	50(1H)
静电容量	公差	品名	
0.1pF(R10)	±0.05pF(W)		GJM1555C1HR10WB01D
	±0.1pF(B)		GJM1555C1HR10BB01D
0.2pF(R20)	±0.05pF(W)	GJM0335C1ER20WB01D	GJM1555C1HR20WB01D
	±0.1pF(B)	GJM0335C1ER20BB01D	GJM1555C1HR20BB01D
0.3pF(R30)	±0.05pF(W)	GJM0335C1ER30WB01D	GJM1555C1HR30WB01D
	±0.1pF(B)	GJM0335C1ER30BB01D	GJM1555C1HR30BB01D
0.4pF(R40)	±0.05pF(W)	GJM0335C1ER40WB01D	GJM1555C1HR40WB01D
	±0.1pF(B)	GJM0335C1ER40BB01D	GJM1555C1HR40BB01D
0.5pF(R50)	±0.05pF(W)	GJM0335C1ER50WB01D	GJM1555C1HR50WB01D
	±0.1pF(B)	GJM0335C1ER50BB01D	GJM1555C1HR50BB01D
0.6pF(R60)	±0.05pF(W)	GJM0335C1ER60WB01D	GJM1555C1HR60WB01D
	±0.1pF(B)	GJM0335C1ER60BB01D	GJM1555C1HR60BB01D
0.7pF(R70)	±0.05pF(W)	GJM0335C1ER70WB01D	GJM1555C1HR70WB01D
	±0.1pF(B)	GJM0335C1ER70BB01D	GJM1555C1HR70BB01D
0.8pF(R80)	±0.05pF(W)	GJM0335C1ER80WB01D	GJM1555C1HR80WB01D
	±0.1pF(B)	GJM0335C1ER80BB01D	GJM1555C1HR80BB01D
0.9pF(R90)	±0.05pF(W)	GJM0335C1ER90WB01D	GJM1555C1HR90WB01D
	±0.1pF(B)	GJM0335C1ER90BB01D	GJM1555C1HR90BB01D
1.0pF(1R0)	±0.05pF(W)	GJM0335C1E1R0WB01D	GJM1555C1H1R0WB01D
	±0.1pF(B)	GJM0335C1E1R0BB01D	GJM1555C1H1R0BB01D
	±0.25pF(C)	GJM0335C1E1R0CB01D	GJM1555C1H1R0CB01D
1.1pF(1R1)	±0.05pF(W)	GJM0335C1E1R1WB01D	GJM1555C1H1R1WB01D
	±0.1pF(B)	GJM0335C1E1R1BB01D	GJM1555C1H1R1BB01D
	±0.25pF(C)	GJM0335C1E1R1CB01D	GJM1555C1H1R1CB01D
1.2pF(1R2)	±0.05pF(W)	GJM0335C1E1R2WB01D	GJM1555C1H1R2WB01D
	±0.1pF(B)	GJM0335C1E1R2BB01D	GJM1555C1H1R2BB01D
	±0.25pF(C)	GJM0335C1E1R2CB01D	GJM1555C1H1R2CB01D
1.3pF(1R3)	±0.05pF(W)	GJM0335C1E1R3WB01D	GJM1555C1H1R3WB01D
	±0.1pF(B)	GJM0335C1E1R3BB01D	GJM1555C1H1R3BB01D
	±0.25pF(C)	GJM0335C1E1R3CB01D	GJM1555C1H1R3CB01D
1.4pF(1R4)	±0.05pF(W)	GJM0335C1E1R4WB01D	GJM1555C1H1R4WB01D
	±0.1pF(B)	GJM0335C1E1R4BB01D	GJM1555C1H1R4BB01D
	±0.25pF(C)	GJM0335C1E1R4CB01D	GJM1555C1H1R4CB01D
1.5pF(1R5)	±0.05pF(W)	GJM0335C1E1R5WB01D	GJM1555C1H1R5WB01D
	±0.1pF(B)	GJM0335C1E1R5BB01D	GJM1555C1H1R5BB01D
	±0.25pF(C)	GJM0335C1E1R5CB01D	GJM1555C1H1R5CB01D
1.6pF(1R6)	±0.05pF(W)	GJM0335C1E1R6WB01D	GJM1555C1H1R6WB01D
	±0.1pF(B)	GJM0335C1E1R6BB01D	GJM1555C1H1R6BB01D
	±0.25pF(C)	GJM0335C1E1R6CB01D	GJM1555C1H1R6CB01D
1.7pF(1R7)	±0.05pF(W)	GJM0335C1E1R7WB01D	GJM1555C1H1R7WB01D
	±0.1pF(B)	GJM0335C1E1R7BB01D	GJM1555C1H1R7BB01D
	±0.25pF(C)	GJM0335C1E1R7CB01D	GJM1555C1H1R7CB01D
1.8pF(1R8)	±0.05pF(W)	GJM0335C1E1R8WB01D	GJM1555C1H1R8WB01D
	±0.1pF(B)	GJM0335C1E1R8BB01D	GJM1555C1H1R8BB01D
	±0.25pF(C)	GJM0335C1E1R8CB01D	GJM1555C1H1R8CB01D
1.9pF(1R9)	±0.05pF(W)	GJM0335C1E1R9WB01D	GJM1555C1H1R9WB01D
	±0.1pF(B)	GJM0335C1E1R9BB01D	GJM1555C1H1R9BB01D
	±0.25pF(C)	GJM0335C1E1R9CB01D	GJM1555C1H1R9CB01D
2.0pF(2R0)	±0.05pF(W)	GJM0335C1E2R0WB01D	GJM1555C1H2R0WB01D
	±0.1pF(B)	GJM0335C1E2R0BB01D	GJM1555C1H2R0BB01D
	±0.25pF(C)	GJM0335C1E2R0CB01D	GJM1555C1H2R0CB01D

品名代号在()中注明，单位在 []中注明。< >: EIA [英寸] 代号

(品名) **GJ** **M** **03** **3** **5C** **1E** **R20** **W** **B01** **D**
 ① ② ③ ④ ⑤ ⑥ ⑦ ⑧ ⑨ ⑩

- ① 型号
- ② 系列
- ③ 尺寸 (长 × 宽)
- ④ 尺寸 (厚度)
- ⑤ 温度特性
- ⑥ 额定电压
- ⑦ 静电容量
- ⑧ 静电容量公差
- ⑨ 个别规格代号
- ⑩ 包装

品名中的包装代号表示标准180mm卷盘。

温度补偿型 C0G(5C) 特性

长x宽 [mm]		0.6x0.3(03)<0201>	1.0x0.5(15)<0402>
额定电压 [Vdc]		25(1E)	50(1H)
静电容量	公差	品名	
2.1pF(2R1)	±0.05pF(W)	GJM0335C1E2R1WB01D	GJM1555C1H2R1WB01D
	±0.1pF(B)	GJM0335C1E2R1BB01D	GJM1555C1H2R1BB01D
	±0.25pF(C)	GJM0335C1E2R1CB01D	GJM1555C1H2R1CB01D
2.2pF(2R2)	±0.05pF(W)	GJM0335C1E2R2WB01D	GJM1555C1H2R2WB01D
	±0.1pF(B)	GJM0335C1E2R2BB01D	GJM1555C1H2R2BB01D
	±0.25pF(C)	GJM0335C1E2R2CB01D	GJM1555C1H2R2CB01D
2.3pF(2R3)	±0.05pF(W)	GJM0335C1E2R3WB01D	GJM1555C1H2R3WB01D
	±0.1pF(B)	GJM0335C1E2R3BB01D	GJM1555C1H2R3BB01D
	±0.25pF(C)	GJM0335C1E2R3CB01D	GJM1555C1H2R3CB01D
2.4pF(2R4)	±0.05pF(W)	GJM0335C1E2R4WB01D	GJM1555C1H2R4WB01D
	±0.1pF(B)	GJM0335C1E2R4BB01D	GJM1555C1H2R4BB01D
	±0.25pF(C)	GJM0335C1E2R4CB01D	GJM1555C1H2R4CB01D
2.5pF(2R5)	±0.05pF(W)	GJM0335C1E2R5WB01D	GJM1555C1H2R5WB01D
	±0.1pF(B)	GJM0335C1E2R5BB01D	GJM1555C1H2R5BB01D
	±0.25pF(C)	GJM0335C1E2R5CB01D	GJM1555C1H2R5CB01D
2.6pF(2R6)	±0.05pF(W)	GJM0335C1E2R6WB01D	GJM1555C1H2R6WB01D
	±0.1pF(B)	GJM0335C1E2R6BB01D	GJM1555C1H2R6BB01D
	±0.25pF(C)	GJM0335C1E2R6CB01D	GJM1555C1H2R6CB01D
2.7pF(2R7)	±0.05pF(W)	GJM0335C1E2R7WB01D	GJM1555C1H2R7WB01D
	±0.1pF(B)	GJM0335C1E2R7BB01D	GJM1555C1H2R7BB01D
	±0.25pF(C)	GJM0335C1E2R7CB01D	GJM1555C1H2R7CB01D
2.8pF(2R8)	±0.05pF(W)	GJM0335C1E2R8WB01D	GJM1555C1H2R8WB01D
	±0.1pF(B)	GJM0335C1E2R8BB01D	GJM1555C1H2R8BB01D
	±0.25pF(C)	GJM0335C1E2R8CB01D	GJM1555C1H2R8CB01D
2.9pF(2R9)	±0.05pF(W)	GJM0335C1E2R9WB01D	GJM1555C1H2R9WB01D
	±0.1pF(B)	GJM0335C1E2R9BB01D	GJM1555C1H2R9BB01D
	±0.25pF(C)	GJM0335C1E2R9CB01D	GJM1555C1H2R9CB01D
3.0pF(3R0)	±0.05pF(W)	GJM0335C1E3R0WB01D	GJM1555C1H3R0WB01D
	±0.1pF(B)	GJM0335C1E3R0BB01D	GJM1555C1H3R0BB01D
	±0.25pF(C)	GJM0335C1E3R0CB01D	GJM1555C1H3R0CB01D
3.1pF(3R1)	±0.05pF(W)	GJM0335C1E3R1WB01D	GJM1555C1H3R1WB01D
	±0.1pF(B)	GJM0335C1E3R1BB01D	GJM1555C1H3R1BB01D
	±0.25pF(C)	GJM0335C1E3R1CB01D	GJM1555C1H3R1CB01D
3.2pF(3R2)	±0.05pF(W)	GJM0335C1E3R2WB01D	GJM1555C1H3R2WB01D
	±0.1pF(B)	GJM0335C1E3R2BB01D	GJM1555C1H3R2BB01D
	±0.25pF(C)	GJM0335C1E3R2CB01D	GJM1555C1H3R2CB01D
3.3pF(3R3)	±0.05pF(W)	GJM0335C1E3R3WB01D	GJM1555C1H3R3WB01D
	±0.1pF(B)	GJM0335C1E3R3BB01D	GJM1555C1H3R3BB01D
	±0.25pF(C)	GJM0335C1E3R3CB01D	GJM1555C1H3R3CB01D
3.4pF(3R4)	±0.05pF(W)	GJM0335C1E3R4WB01D	GJM1555C1H3R4WB01D
	±0.1pF(B)	GJM0335C1E3R4BB01D	GJM1555C1H3R4BB01D
	±0.25pF(C)	GJM0335C1E3R4CB01D	GJM1555C1H3R4CB01D
3.5pF(3R5)	±0.05pF(W)	GJM0335C1E3R5WB01D	GJM1555C1H3R5WB01D
	±0.1pF(B)	GJM0335C1E3R5BB01D	GJM1555C1H3R5BB01D
	±0.25pF(C)	GJM0335C1E3R5CB01D	GJM1555C1H3R5CB01D
3.6pF(3R6)	±0.05pF(W)	GJM0335C1E3R6WB01D	GJM1555C1H3R6WB01D
	±0.1pF(B)	GJM0335C1E3R6BB01D	GJM1555C1H3R6BB01D
	±0.25pF(C)	GJM0335C1E3R6CB01D	GJM1555C1H3R6CB01D

品名代号在()中注明，单位在[]中注明。< >: EIA [英寸] 代号

温度补偿型 C0G(5C) 特性

长x宽 [mm]		0.6x0.3(03)<0201>	1.0x0.5(15)<0402>
额定电压 [Vdc]		25(1E)	50(1H)
静电容量	公差	品名	
3.7pF(3R7)	±0.05pF(W)	GJM0335C1E3R7WB01D	GJM1555C1H3R7WB01D
	±0.1pF(B)	GJM0335C1E3R7BB01D	GJM1555C1H3R7BB01D
	±0.25pF(C)	GJM0335C1E3R7CB01D	GJM1555C1H3R7CB01D
3.8pF(3R8)	±0.05pF(W)	GJM0335C1E3R8WB01D	GJM1555C1H3R8WB01D
	±0.1pF(B)	GJM0335C1E3R8BB01D	GJM1555C1H3R8BB01D
	±0.25pF(C)	GJM0335C1E3R8CB01D	GJM1555C1H3R8CB01D
3.9pF(3R9)	±0.05pF(W)	GJM0335C1E3R9WB01D	GJM1555C1H3R9WB01D
	±0.1pF(B)	GJM0335C1E3R9BB01D	GJM1555C1H3R9BB01D
	±0.25pF(C)	GJM0335C1E3R9CB01D	GJM1555C1H3R9CB01D
4.0pF(4R0)	±0.05pF(W)	GJM0335C1E4R0WB01D	GJM1555C1H4R0WB01D
	±0.1pF(B)	GJM0335C1E4R0BB01D	GJM1555C1H4R0BB01D
	±0.25pF(C)	GJM0335C1E4R0CB01D	GJM1555C1H4R0CB01D
4.1pF(4R1)	±0.05pF(W)	GJM0335C1E4R1WB01D	GJM1555C1H4R1WB01D
	±0.1pF(B)	GJM0335C1E4R1BB01D	GJM1555C1H4R1BB01D
	±0.25pF(C)	GJM0335C1E4R1CB01D	GJM1555C1H4R1CB01D
4.2pF(4R2)	±0.05pF(W)	GJM0335C1E4R2WB01D	GJM1555C1H4R2WB01D
	±0.1pF(B)	GJM0335C1E4R2BB01D	GJM1555C1H4R2BB01D
	±0.25pF(C)	GJM0335C1E4R2CB01D	GJM1555C1H4R2CB01D
4.3pF(4R3)	±0.05pF(W)	GJM0335C1E4R3WB01D	GJM1555C1H4R3WB01D
	±0.1pF(B)	GJM0335C1E4R3BB01D	GJM1555C1H4R3BB01D
	±0.25pF(C)	GJM0335C1E4R3CB01D	GJM1555C1H4R3CB01D
4.4pF(4R4)	±0.05pF(W)	GJM0335C1E4R4WB01D	GJM1555C1H4R4WB01D
	±0.1pF(B)	GJM0335C1E4R4BB01D	GJM1555C1H4R4BB01D
	±0.25pF(C)	GJM0335C1E4R4CB01D	GJM1555C1H4R4CB01D
4.5pF(4R5)	±0.05pF(W)	GJM0335C1E4R5WB01D	GJM1555C1H4R5WB01D
	±0.1pF(B)	GJM0335C1E4R5BB01D	GJM1555C1H4R5BB01D
	±0.25pF(C)	GJM0335C1E4R5CB01D	GJM1555C1H4R5CB01D
4.6pF(4R6)	±0.05pF(W)	GJM0335C1E4R6WB01D	GJM1555C1H4R6WB01D
	±0.1pF(B)	GJM0335C1E4R6BB01D	GJM1555C1H4R6BB01D
	±0.25pF(C)	GJM0335C1E4R6CB01D	GJM1555C1H4R6CB01D
4.7pF(4R7)	±0.05pF(W)	GJM0335C1E4R7WB01D	GJM1555C1H4R7WB01D
	±0.1pF(B)	GJM0335C1E4R7BB01D	GJM1555C1H4R7BB01D
	±0.25pF(C)	GJM0335C1E4R7CB01D	GJM1555C1H4R7CB01D
4.8pF(4R8)	±0.05pF(W)	GJM0335C1E4R8WB01D	GJM1555C1H4R8WB01D
	±0.1pF(B)	GJM0335C1E4R8BB01D	GJM1555C1H4R8BB01D
	±0.25pF(C)	GJM0335C1E4R8CB01D	GJM1555C1H4R8CB01D
4.9pF(4R9)	±0.05pF(W)	GJM0335C1E4R9WB01D	GJM1555C1H4R9WB01D
	±0.1pF(B)	GJM0335C1E4R9BB01D	GJM1555C1H4R9BB01D
	±0.25pF(C)	GJM0335C1E4R9CB01D	GJM1555C1H4R9CB01D
5.0pF(5R0)	±0.05pF(W)	GJM0335C1E5R0WB01D	GJM1555C1H5R0WB01D
	±0.1pF(B)	GJM0335C1E5R0BB01D	GJM1555C1H5R0BB01D
	±0.25pF(C)	GJM0335C1E5R0CB01D	GJM1555C1H5R0CB01D
5.1pF(5R1)	±0.05pF(W)	GJM0335C1E5R1WB01D	GJM1555C1H5R1WB01D
	±0.1pF(B)	GJM0335C1E5R1BB01D	GJM1555C1H5R1BB01D
	±0.25pF(C)	GJM0335C1E5R1CB01D	GJM1555C1H5R1CB01D
	±0.5pF(D)	GJM0335C1E5R1DB01D	GJM1555C1H5R1DB01D

品名代号在()中注明，单位在 []中注明。<->: EIA [英寸] 代号

- (品名) **GJ** **M** **03** **3** **5C** **1E** **3R7** **W** **B01** **D** ①型号 ②系列 ③尺寸(长×宽) ④尺寸(厚度) ⑤温度特性
 ① ② ③ ④ ⑤ ⑥ ⑦ ⑧ ⑨ ⑩ ⑥额定电压 ⑦静电容量 ⑧静电容量公差 ⑨个别规格代号 ⑩包装

品名中的包装代号表示标准180mm卷盘。

温度补偿型 C0G(5C) 特性

长x宽 [mm]		0.6x0.3(03)<0201>		1.0x0.5(15)<0402>	
额定电压 [Vdc]		25(1E)		50(1H)	
静电容量	公差	品名			
5.2pF(5R2)	±0.05pF(W)	GJM0335C1E5R2WB01D	GJM1555C1H5R2WB01D		
	±0.1pF(B)	GJM0335C1E5R2BB01D	GJM1555C1H5R2BB01D		
	±0.25pF(C)	GJM0335C1E5R2CB01D	GJM1555C1H5R2CB01D		
	±0.5pF(D)	GJM0335C1E5R2DB01D	GJM1555C1H5R2DB01D		
5.3pF(5R3)	±0.05pF(W)	GJM0335C1E5R3WB01D	GJM1555C1H5R3WB01D		
	±0.1pF(B)	GJM0335C1E5R3BB01D	GJM1555C1H5R3BB01D		
	±0.25pF(C)	GJM0335C1E5R3CB01D	GJM1555C1H5R3CB01D		
	±0.5pF(D)	GJM0335C1E5R3DB01D	GJM1555C1H5R3DB01D		
5.4pF(5R4)	±0.05pF(W)	GJM0335C1E5R4WB01D	GJM1555C1H5R4WB01D		
	±0.1pF(B)	GJM0335C1E5R4BB01D	GJM1555C1H5R4BB01D		
	±0.25pF(C)	GJM0335C1E5R4CB01D	GJM1555C1H5R4CB01D		
	±0.5pF(D)	GJM0335C1E5R4DB01D	GJM1555C1H5R4DB01D		
5.5pF(5R5)	±0.05pF(W)	GJM0335C1E5R5WB01D	GJM1555C1H5R5WB01D		
	±0.1pF(B)	GJM0335C1E5R5BB01D	GJM1555C1H5R5BB01D		
	±0.25pF(C)	GJM0335C1E5R5CB01D	GJM1555C1H5R5CB01D		
	±0.5pF(D)	GJM0335C1E5R5DB01D	GJM1555C1H5R5DB01D		
5.6pF(5R6)	±0.05pF(W)	GJM0335C1E5R6WB01D	GJM1555C1H5R6WB01D		
	±0.1pF(B)	GJM0335C1E5R6BB01D	GJM1555C1H5R6BB01D		
	±0.25pF(C)	GJM0335C1E5R6CB01D	GJM1555C1H5R6CB01D		
	±0.5pF(D)	GJM0335C1E5R6DB01D	GJM1555C1H5R6DB01D		
5.7pF(5R7)	±0.05pF(W)	GJM0335C1E5R7WB01D	GJM1555C1H5R7WB01D		
	±0.1pF(B)	GJM0335C1E5R7BB01D	GJM1555C1H5R7BB01D		
	±0.25pF(C)	GJM0335C1E5R7CB01D	GJM1555C1H5R7CB01D		
	±0.5pF(D)	GJM0335C1E5R7DB01D	GJM1555C1H5R7DB01D		
5.8pF(5R8)	±0.05pF(W)	GJM0335C1E5R8WB01D	GJM1555C1H5R8WB01D		
	±0.1pF(B)	GJM0335C1E5R8BB01D	GJM1555C1H5R8BB01D		
	±0.25pF(C)	GJM0335C1E5R8CB01D	GJM1555C1H5R8CB01D		
	±0.5pF(D)	GJM0335C1E5R8DB01D	GJM1555C1H5R8DB01D		
5.9pF(5R9)	±0.05pF(W)	GJM0335C1E5R9WB01D	GJM1555C1H5R9WB01D		
	±0.1pF(B)	GJM0335C1E5R9BB01D	GJM1555C1H5R9BB01D		
	±0.25pF(C)	GJM0335C1E5R9CB01D	GJM1555C1H5R9CB01D		
	±0.5pF(D)	GJM0335C1E5R9DB01D	GJM1555C1H5R9DB01D		
6.0pF(6R0)	±0.05pF(W)	GJM0335C1E6R0WB01D	GJM1555C1H6R0WB01D		
	±0.1pF(B)	GJM0335C1E6R0BB01D	GJM1555C1H6R0BB01D		
	±0.25pF(C)	GJM0335C1E6R0CB01D	GJM1555C1H6R0CB01D		
	±0.5pF(D)	GJM0335C1E6R0DB01D	GJM1555C1H6R0DB01D		
6.1pF(6R1)	±0.05pF(W)	GJM0335C1E6R1WB01D	GJM1555C1H6R1WB01D		
	±0.1pF(B)	GJM0335C1E6R1BB01D	GJM1555C1H6R1BB01D		
	±0.25pF(C)	GJM0335C1E6R1CB01D	GJM1555C1H6R1CB01D		
	±0.5pF(D)	GJM0335C1E6R1DB01D	GJM1555C1H6R1DB01D		
6.2pF(6R2)	±0.05pF(W)	GJM0335C1E6R2WB01D	GJM1555C1H6R2WB01D		
	±0.1pF(B)	GJM0335C1E6R2BB01D	GJM1555C1H6R2BB01D		
	±0.25pF(C)	GJM0335C1E6R2CB01D	GJM1555C1H6R2CB01D		
	±0.5pF(D)	GJM0335C1E6R2DB01D	GJM1555C1H6R2DB01D		
6.3pF(6R3)	±0.05pF(W)	GJM0335C1E6R3WB01D	GJM1555C1H6R3WB01D		
	±0.1pF(B)	GJM0335C1E6R3BB01D	GJM1555C1H6R3BB01D		
	±0.25pF(C)	GJM0335C1E6R3CB01D	GJM1555C1H6R3CB01D		
	±0.5pF(D)	GJM0335C1E6R3DB01D	GJM1555C1H6R3DB01D		
6.4pF(6R4)	±0.05pF(W)	GJM0335C1E6R4WB01D	GJM1555C1H6R4WB01D		
	±0.1pF(B)	GJM0335C1E6R4BB01D	GJM1555C1H6R4BB01D		
	±0.25pF(C)	GJM0335C1E6R4CB01D	GJM1555C1H6R4CB01D		
	±0.5pF(D)	GJM0335C1E6R4DB01D	GJM1555C1H6R4DB01D		

品名代号在()中注明，单位在 []中注明。<->: EIA [英寸] 代号

温度补偿型 C0G(5C)/C0H(6C)特性

长x宽 [mm]		0.6x0.3(03)<0201>	1.0x0.5(15)<0402>
额定电压 [Vdc]		25(1E)	50(1H)
静电容量	公差	品名	
6.5pF(6R5)	±0.05pF(W)	GJM0335C1E6R5WB01D	GJM1555C1H6R5WB01D
	±0.1pF(B)	GJM0335C1E6R5BB01D	GJM1555C1H6R5BB01D
	±0.25pF(C)	GJM0335C1E6R5CB01D	GJM1555C1H6R5CB01D
	±0.5pF(D)	GJM0335C1E6R5DB01D	GJM1555C1H6R5DB01D
6.6pF(6R6)	±0.05pF(W)	GJM0335C1E6R6WB01D	GJM1555C1H6R6WB01D
	±0.1pF(B)	GJM0335C1E6R6BB01D	GJM1555C1H6R6BB01D
	±0.25pF(C)	GJM0335C1E6R6CB01D	GJM1555C1H6R6CB01D
	±0.5pF(D)	GJM0335C1E6R6DB01D	GJM1555C1H6R6DB01D
6.7pF(6R7)	±0.05pF(W)	GJM0335C1E6R7WB01D	GJM1555C1H6R7WB01D
	±0.1pF(B)	GJM0335C1E6R7BB01D	GJM1555C1H6R7BB01D
	±0.25pF(C)	GJM0335C1E6R7CB01D	GJM1555C1H6R7CB01D
	±0.5pF(D)	GJM0335C1E6R7DB01D	GJM1555C1H6R7DB01D
6.8pF(6R8)	±0.05pF(W)	GJM0335C1E6R8WB01D	GJM1555C1H6R8WB01D
	±0.1pF(B)	GJM0335C1E6R8BB01D	GJM1555C1H6R8BB01D
	±0.25pF(C)	GJM0335C1E6R8CB01D	GJM1555C1H6R8CB01D
	±0.5pF(D)	GJM0335C1E6R8DB01D	GJM1555C1H6R8DB01D
6.9pF(6R9)	±0.05pF(W)	GJM0336C1E6R9WB01D	GJM1555C1H6R9WB01D
	±0.1pF(B)	GJM0336C1E6R9BB01D	GJM1555C1H6R9BB01D
	±0.25pF(C)	GJM0336C1E6R9CB01D	GJM1555C1H6R9CB01D
	±0.5pF(D)	GJM0336C1E6R9DB01D	GJM1555C1H6R9DB01D
7.0pF(7R0)	±0.05pF(W)	GJM0336C1E7R0WB01D	GJM1555C1H7R0WB01D
	±0.1pF(B)	GJM0336C1E7R0BB01D	GJM1555C1H7R0BB01D
	±0.25pF(C)	GJM0336C1E7R0CB01D	GJM1555C1H7R0CB01D
	±0.5pF(D)	GJM0336C1E7R0DB01D	GJM1555C1H7R0DB01D
7.1pF(7R1)	±0.05pF(W)	GJM0336C1E7R1WB01D	GJM1555C1H7R1WB01D
	±0.1pF(B)	GJM0336C1E7R1BB01D	GJM1555C1H7R1BB01D
	±0.25pF(C)	GJM0336C1E7R1CB01D	GJM1555C1H7R1CB01D
	±0.5pF(D)	GJM0336C1E7R1DB01D	GJM1555C1H7R1DB01D
7.2pF(7R2)	±0.05pF(W)	GJM0336C1E7R2WB01D	GJM1555C1H7R2WB01D
	±0.1pF(B)	GJM0336C1E7R2BB01D	GJM1555C1H7R2BB01D
	±0.25pF(C)	GJM0336C1E7R2CB01D	GJM1555C1H7R2CB01D
	±0.5pF(D)	GJM0336C1E7R2DB01D	GJM1555C1H7R2DB01D
7.3pF(7R3)	±0.05pF(W)	GJM0336C1E7R3WB01D	GJM1555C1H7R3WB01D
	±0.1pF(B)	GJM0336C1E7R3BB01D	GJM1555C1H7R3BB01D
	±0.25pF(C)	GJM0336C1E7R3CB01D	GJM1555C1H7R3CB01D
	±0.5pF(D)	GJM0336C1E7R3DB01D	GJM1555C1H7R3DB01D
7.4pF(7R4)	±0.05pF(W)	GJM0336C1E7R4WB01D	GJM1555C1H7R4WB01D
	±0.1pF(B)	GJM0336C1E7R4BB01D	GJM1555C1H7R4BB01D
	±0.25pF(C)	GJM0336C1E7R4CB01D	GJM1555C1H7R4CB01D
	±0.5pF(D)	GJM0336C1E7R4DB01D	GJM1555C1H7R4DB01D
7.5pF(7R5)	±0.05pF(W)	GJM0336C1E7R5WB01D	GJM1555C1H7R5WB01D
	±0.1pF(B)	GJM0336C1E7R5BB01D	GJM1555C1H7R5BB01D
	±0.25pF(C)	GJM0336C1E7R5CB01D	GJM1555C1H7R5CB01D
	±0.5pF(D)	GJM0336C1E7R5DB01D	GJM1555C1H7R5DB01D
7.6pF(7R6)	±0.05pF(W)	GJM0336C1E7R6WB01D	GJM1555C1H7R6WB01D
	±0.1pF(B)	GJM0336C1E7R6BB01D	GJM1555C1H7R6BB01D
	±0.25pF(C)	GJM0336C1E7R6CB01D	GJM1555C1H7R6CB01D
	±0.5pF(D)	GJM0336C1E7R6DB01D	GJM1555C1H7R6DB01D

品名代号在()中注明，单位在[]中注明。< >: EIA [英寸] 代号

- (品名) **GJ** **M** **03** **3** **5C** **1E** **6R5** **W** **B01** **D** ①型号 ②系列 ③尺寸(长×宽) ④尺寸(厚度) ⑤温度特性
 ① ② ③ ④ ⑤ ⑥ ⑦ ⑧ ⑨ ⑩ ⑥额定电压 ⑦静电容量 ⑧静电容量公差 ⑨个别规格代号 ⑩包装

品名中的包装代号表示标准180mm卷盘。

温度补偿型 C0G(5C)/C0H(6C) 特性

长x宽 [mm]		0.6x0.3(03)<0201>	1.0x0.5(15)<0402>
额定电压 [Vdc]		25(1E)	50(1H)
静电容量	公差	品名	
7.7pF(7R7)	±0.05pF(W)	GJM0336C1E7R7WB01D	GJM1555C1H7R7WB01D
	±0.1pF(B)	GJM0336C1E7R7BB01D	GJM1555C1H7R7BB01D
	±0.25pF(C)	GJM0336C1E7R7CB01D	GJM1555C1H7R7CB01D
	±0.5pF(D)	GJM0336C1E7R7DB01D	GJM1555C1H7R7DB01D
7.8pF(7R8)	±0.05pF(W)	GJM0336C1E7R8WB01D	GJM1555C1H7R8WB01D
	±0.1pF(B)	GJM0336C1E7R8BB01D	GJM1555C1H7R8BB01D
	±0.25pF(C)	GJM0336C1E7R8CB01D	GJM1555C1H7R8CB01D
	±0.5pF(D)	GJM0336C1E7R8DB01D	GJM1555C1H7R8DB01D
7.9pF(7R9)	±0.05pF(W)	GJM0336C1E7R9WB01D	GJM1555C1H7R9WB01D
	±0.1pF(B)	GJM0336C1E7R9BB01D	GJM1555C1H7R9BB01D
	±0.25pF(C)	GJM0336C1E7R9CB01D	GJM1555C1H7R9CB01D
	±0.5pF(D)	GJM0336C1E7R9DB01D	GJM1555C1H7R9DB01D
8.0pF(8R0)	±0.05pF(W)	GJM0336C1E8R0WB01D	GJM1555C1H8R0WB01D
	±0.1pF(B)	GJM0336C1E8R0BB01D	GJM1555C1H8R0BB01D
	±0.25pF(C)	GJM0336C1E8R0CB01D	GJM1555C1H8R0CB01D
	±0.5pF(D)	GJM0336C1E8R0DB01D	GJM1555C1H8R0DB01D
8.1pF(8R1)	±0.05pF(W)	GJM0336C1E8R1WB01D	GJM1555C1H8R1WB01D
	±0.1pF(B)	GJM0336C1E8R1BB01D	GJM1555C1H8R1BB01D
	±0.25pF(C)	GJM0336C1E8R1CB01D	GJM1555C1H8R1CB01D
	±0.5pF(D)	GJM0336C1E8R1DB01D	GJM1555C1H8R1DB01D
8.2pF(8R2)	±0.05pF(W)	GJM0336C1E8R2WB01D	GJM1555C1H8R2WB01D
	±0.1pF(B)	GJM0336C1E8R2BB01D	GJM1555C1H8R2BB01D
	±0.25pF(C)	GJM0336C1E8R2CB01D	GJM1555C1H8R2CB01D
	±0.5pF(D)	GJM0336C1E8R2DB01D	GJM1555C1H8R2DB01D
8.3pF(8R3)	±0.05pF(W)	GJM0336C1E8R3WB01D	GJM1555C1H8R3WB01D
	±0.1pF(B)	GJM0336C1E8R3BB01D	GJM1555C1H8R3BB01D
	±0.25pF(C)	GJM0336C1E8R3CB01D	GJM1555C1H8R3CB01D
	±0.5pF(D)	GJM0336C1E8R3DB01D	GJM1555C1H8R3DB01D
8.4pF(8R4)	±0.05pF(W)	GJM0336C1E8R4WB01D	GJM1555C1H8R4WB01D
	±0.1pF(B)	GJM0336C1E8R4BB01D	GJM1555C1H8R4BB01D
	±0.25pF(C)	GJM0336C1E8R4CB01D	GJM1555C1H8R4CB01D
	±0.5pF(D)	GJM0336C1E8R4DB01D	GJM1555C1H8R4DB01D
8.5pF(8R5)	±0.05pF(W)	GJM0336C1E8R5WB01D	GJM1555C1H8R5WB01D
	±0.1pF(B)	GJM0336C1E8R5BB01D	GJM1555C1H8R5BB01D
	±0.25pF(C)	GJM0336C1E8R5CB01D	GJM1555C1H8R5CB01D
	±0.5pF(D)	GJM0336C1E8R5DB01D	GJM1555C1H8R5DB01D
8.6pF(8R6)	±0.05pF(W)	GJM0336C1E8R6WB01D	GJM1555C1H8R6WB01D
	±0.1pF(B)	GJM0336C1E8R6BB01D	GJM1555C1H8R6BB01D
	±0.25pF(C)	GJM0336C1E8R6CB01D	GJM1555C1H8R6CB01D
	±0.5pF(D)	GJM0336C1E8R6DB01D	GJM1555C1H8R6DB01D
8.7pF(8R7)	±0.05pF(W)	GJM0336C1E8R7WB01D	GJM1555C1H8R7WB01D
	±0.1pF(B)	GJM0336C1E8R7BB01D	GJM1555C1H8R7BB01D
	±0.25pF(C)	GJM0336C1E8R7CB01D	GJM1555C1H8R7CB01D
	±0.5pF(D)	GJM0336C1E8R7DB01D	GJM1555C1H8R7DB01D
8.8pF(8R8)	±0.05pF(W)	GJM0336C1E8R8WB01D	GJM1555C1H8R8WB01D
	±0.1pF(B)	GJM0336C1E8R8BB01D	GJM1555C1H8R8BB01D
	±0.25pF(C)	GJM0336C1E8R8CB01D	GJM1555C1H8R8CB01D
	±0.5pF(D)	GJM0336C1E8R8DB01D	GJM1555C1H8R8DB01D
8.9pF(8R9)	±0.05pF(W)	GJM0336C1E8R9WB01D	GJM1555C1H8R9WB01D
	±0.1pF(B)	GJM0336C1E8R9BB01D	GJM1555C1H8R9BB01D
	±0.25pF(C)	GJM0336C1E8R9CB01D	GJM1555C1H8R9CB01D
	±0.5pF(D)	GJM0336C1E8R9DB01D	GJM1555C1H8R9DB01D

品名代号在()中注明，单位在 []中注明。<->: EIA [英寸] 代号

温度补偿型 C0G(5C)/C0H(6C) 特性

长x宽 [mm]		0.6x0.3(03)<0201>	1.0x0.5(15)<0402>
额定电压 [Vdc]		25(1E)	50(1H)
静电容量	公差	品名	
9.0pF(9R0)	±0.05pF(W)	GJM0336C1E9R0WB01D	GJM1555C1H9R0WB01D
	±0.1pF(B)	GJM0336C1E9R0BB01D	GJM1555C1H9R0BB01D
	±0.25pF(C)	GJM0336C1E9R0CB01D	GJM1555C1H9R0CB01D
	±0.5pF(D)	GJM0336C1E9R0DB01D	GJM1555C1H9R0DB01D
9.1pF(9R1)	±0.05pF(W)	GJM0336C1E9R1WB01D	GJM1555C1H9R1WB01D
	±0.1pF(B)	GJM0336C1E9R1BB01D	GJM1555C1H9R1BB01D
	±0.25pF(C)	GJM0336C1E9R1CB01D	GJM1555C1H9R1CB01D
	±0.5pF(D)	GJM0336C1E9R1DB01D	GJM1555C1H9R1DB01D
9.2pF(9R2)	±0.05pF(W)	GJM0336C1E9R2WB01D	GJM1555C1H9R2WB01D
	±0.1pF(B)	GJM0336C1E9R2BB01D	GJM1555C1H9R2BB01D
	±0.25pF(C)	GJM0336C1E9R2CB01D	GJM1555C1H9R2CB01D
	±0.5pF(D)	GJM0336C1E9R2DB01D	GJM1555C1H9R2DB01D
9.3pF(9R3)	±0.05pF(W)	GJM0336C1E9R3WB01D	GJM1555C1H9R3WB01D
	±0.1pF(B)	GJM0336C1E9R3BB01D	GJM1555C1H9R3BB01D
	±0.25pF(C)	GJM0336C1E9R3CB01D	GJM1555C1H9R3CB01D
	±0.5pF(D)	GJM0336C1E9R3DB01D	GJM1555C1H9R3DB01D
9.4pF(9R4)	±0.05pF(W)	GJM0336C1E9R4WB01D	GJM1555C1H9R4WB01D
	±0.1pF(B)	GJM0336C1E9R4BB01D	GJM1555C1H9R4BB01D
	±0.25pF(C)	GJM0336C1E9R4CB01D	GJM1555C1H9R4CB01D
	±0.5pF(D)	GJM0336C1E9R4DB01D	GJM1555C1H9R4DB01D
9.5pF(9R5)	±0.05pF(W)	GJM0336C1E9R5WB01D	GJM1555C1H9R5WB01D
	±0.1pF(B)	GJM0336C1E9R5BB01D	GJM1555C1H9R5BB01D
	±0.25pF(C)	GJM0336C1E9R5CB01D	GJM1555C1H9R5CB01D
	±0.5pF(D)	GJM0336C1E9R5DB01D	GJM1555C1H9R5DB01D
9.6pF(9R6)	±0.05pF(W)	GJM0336C1E9R6WB01D	GJM1555C1H9R6WB01D
	±0.1pF(B)	GJM0336C1E9R6BB01D	GJM1555C1H9R6BB01D
	±0.25pF(C)	GJM0336C1E9R6CB01D	GJM1555C1H9R6CB01D
	±0.5pF(D)	GJM0336C1E9R6DB01D	GJM1555C1H9R6DB01D
9.7pF(9R7)	±0.05pF(W)	GJM0336C1E9R7WB01D	GJM1555C1H9R7WB01D
	±0.1pF(B)	GJM0336C1E9R7BB01D	GJM1555C1H9R7BB01D
	±0.25pF(C)	GJM0336C1E9R7CB01D	GJM1555C1H9R7CB01D
	±0.5pF(D)	GJM0336C1E9R7DB01D	GJM1555C1H9R7DB01D
9.8pF(9R8)	±0.05pF(W)	GJM0336C1E9R8WB01D	GJM1555C1H9R8WB01D
	±0.1pF(B)	GJM0336C1E9R8BB01D	GJM1555C1H9R8BB01D
	±0.25pF(C)	GJM0336C1E9R8CB01D	GJM1555C1H9R8CB01D
	±0.5pF(D)	GJM0336C1E9R8DB01D	GJM1555C1H9R8DB01D
9.9pF(9R9)	±0.05pF(W)	GJM0336C1E9R9WB01D	GJM1555C1H9R9WB01D
	±0.1pF(B)	GJM0336C1E9R9BB01D	GJM1555C1H9R9BB01D
	±0.25pF(C)	GJM0336C1E9R9CB01D	GJM1555C1H9R9CB01D
	±0.5pF(D)	GJM0336C1E9R9DB01D	GJM1555C1H9R9DB01D

品名代号在()中注明，单位在 []中注明。 < >: EIA [英寸] 代号

(品名) **GJ** **M** **03** **3** **6C** **1E** **9R0** **W** **B01** **D**
 ① ② ③ ④ ⑤ ⑥ ⑦ ⑧ ⑨ ⑩

- ① 型号
- ② 系列
- ③ 尺寸 (长 × 宽)
- ④ 尺寸 (厚度)
- ⑤ 温度特性
- ⑥ 额定电压
- ⑦ 静电容量
- ⑧ 静电容量公差
- ⑨ 个别规格代号
- ⑩ 包装

品名中的包装代号表示标准180mm卷盘。

温度补偿型 C0G(5C)/C0H(6C) 特性

长x宽 [mm]		0.6x0.3(03)<0201>		1.0x0.5(15)<0402>
额定电压 [Vdc]		25(1E)	6.3(0J)	50(1H)
静电容量	公差	品名		
10pF(100)	±2%(G)	GJM0336C1E100GB01D		GJM1555C1H100GB01D
	±5%(J)	GJM0336C1E100JB01D		GJM1555C1H100JB01D
11pF(110)	±2%(G)	GJM0336C1E110GB01D		GJM1555C1H110GB01D
	±5%(J)	GJM0336C1E110JB01D		GJM1555C1H110JB01D
12pF(120)	±2%(G)	GJM0336C1E120GB01D		GJM1555C1H120GB01D
	±5%(J)	GJM0336C1E120JB01D		GJM1555C1H120JB01D
13pF(130)	±2%(G)	GJM0336C1E130GB01D		GJM1555C1H130GB01D
	±5%(J)	GJM0336C1E130JB01D		GJM1555C1H130JB01D
15pF(150)	±2%(G)	GJM0336C1E150GB01D		GJM1555C1H150GB01D
	±5%(J)	GJM0336C1E150JB01D		GJM1555C1H150JB01D
16pF(160)	±2%(G)	GJM0336C1E160GB01D		GJM1555C1H160GB01D
	±5%(J)	GJM0336C1E160JB01D		GJM1555C1H160JB01D
18pF(180)	±2%(G)	GJM0336C1E180GB01D		GJM1555C1H180GB01D
	±5%(J)	GJM0336C1E180JB01D		GJM1555C1H180JB01D
20pF(200)	±2%(G)	GJM0336C1E200GB01D		GJM1555C1H200GB01D
	±5%(J)	GJM0336C1E200JB01D		GJM1555C1H200JB01D
22pF(220)	±2%(G)		GJM0335C0J220GB01D	
	±5%(J)		GJM0335C0J220JB01D	
24pF(240)	±2%(G)		GJM0335C0J240GB01D	
	±5%(J)		GJM0335C0J240JB01D	
27pF(270)	±2%(G)		GJM0335C0J270GB01D	
	±5%(J)		GJM0335C0J270JB01D	
30pF(300)	±2%(G)		GJM0335C0J300GB01D	
	±5%(J)		GJM0335C0J300JB01D	
33pF(330)	±2%(G)		GJM0335C0J330GB01D	
	±5%(J)		GJM0335C0J330JB01D	

品名代号在()中注明，单位在 []中注明。< >: EIA [英寸] 代号

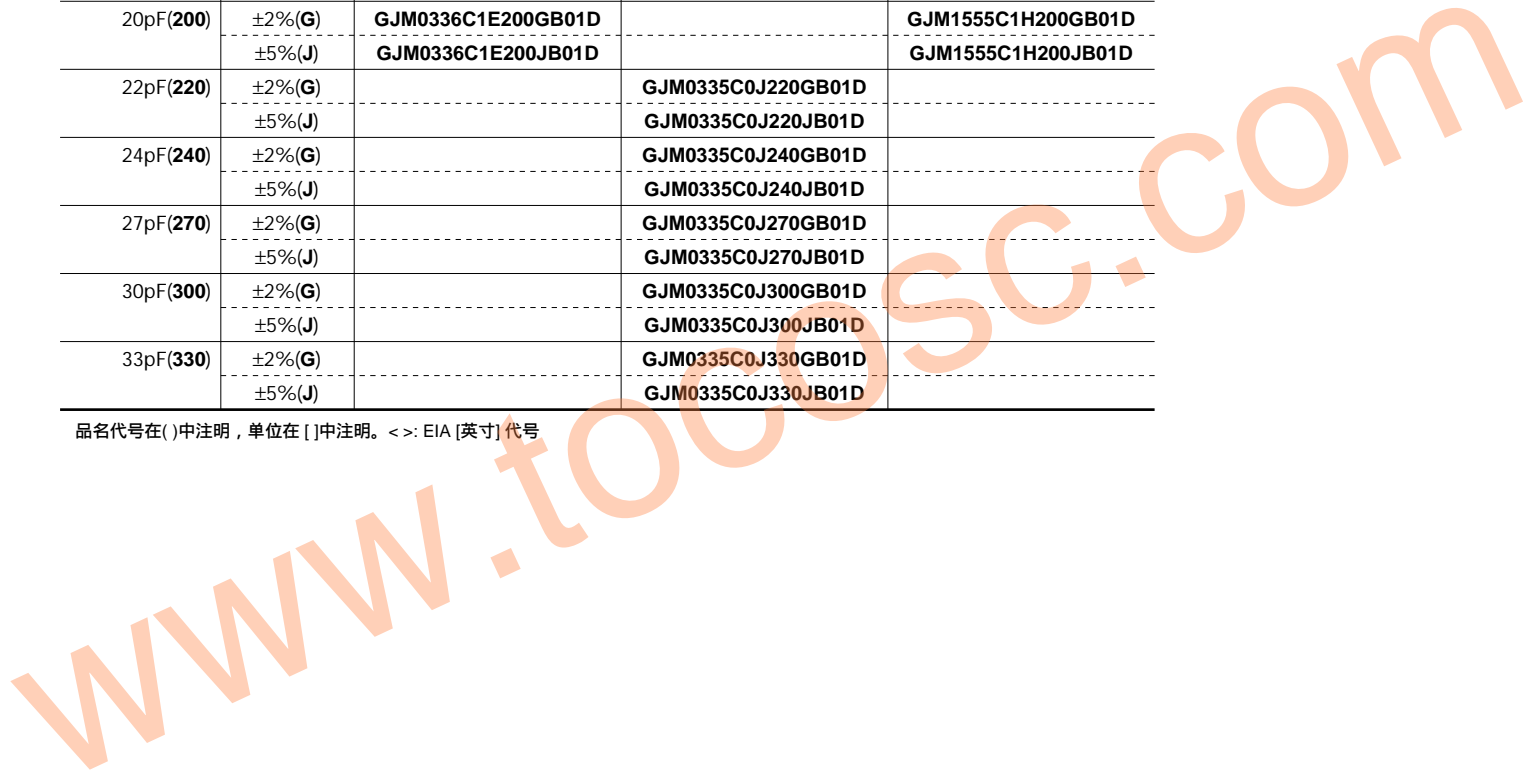

GJM系列规格和测试方法

4

编号	项目	特性		测试方法												
		温度补偿型														
1	动作温度范围	- 55至 + 125°C		参考温度: 25°C (2C, 3C, 4C: 20°C)												
2	额定电压	参见上页		额定电压定义为可向电容器连续施加的最大电压。 当交流电压附加于直流电压时, V^{P-P} 或 V^{O-P} (以较大者为准) 应维持在额定电压范围内。												
3	外观	无缺陷或异常		目视检查												
4	尺寸	在规定尺寸范围内		使用游标卡尺												
5	介电强度	无缺陷或异常		在端子间施加300%额定电压1至5秒时不应观察到任何故障, 并且充电/放电电流低于50mA。												
6	绝缘电阻 (I.R.)	最小10,000MΩ或最小500Ω · F (以较小者为准)		绝缘电阻应在25°C且相对湿度为75%条件下用不超过额定电压的直流电压测量, 时间应选在充电开始后2分钟内。												
7	静电容量	在规定偏差范围内		静电容量/Q值应在25°C条件下, 按表内的频率及电压测量。												
8	Q	30pF及以上: $Q \geq 1000$ 30pF及以下: $Q \geq 400 + 20C$ C: 标称静电容量 (pF)		<table border="1"> <tr> <td>频率</td> <td>1 ± 0.1MHz</td> </tr> <tr> <td>电压</td> <td>0.5至5Vrms</td> </tr> </table>	频率	1 ± 0.1MHz	电压	0.5至5Vrms								
		频率	1 ± 0.1MHz													
电压	0.5至5Vrms															
9	静电容量温度特性	温度系数 在规定的偏差范围内 (表A)	静电容量漂移 在 ± 0.2%或 ± 0.05pF (以较大者为准) 范围内	<p>静电容量变化应在进入规定的各温度阶段5分钟后测量。 温度补偿型 温度系数使用在第3阶段中测得的静电容量作为参考来确定。 在依次通过第1阶段至第5阶段的温度时 (5C: + 25至125°C; 其他温度系数: + 20至125°C), 静电容量应在表A规定的温度系数和静电容量变化偏差范围内。 静电容量漂移是将在第1、3及5阶段测得的最大和最小值之间的差除以第3阶段的静电容量值计算而得。</p> <table border="1"> <thead> <tr> <th>阶段</th> <th>温度 (°C)</th> </tr> </thead> <tbody> <tr> <td>1</td> <td>参考温度 ± 2</td> </tr> <tr> <td>2</td> <td>- 55 ± 3</td> </tr> <tr> <td>3</td> <td>参考温度 ± 2</td> </tr> <tr> <td>4</td> <td>125 ± 3</td> </tr> <tr> <td>5</td> <td>参考温度 ± 2</td> </tr> </tbody> </table>	阶段	温度 (°C)	1	参考温度 ± 2	2	- 55 ± 3	3	参考温度 ± 2	4	125 ± 3	5	参考温度 ± 2
阶段	温度 (°C)															
1	参考温度 ± 2															
2	- 55 ± 3															
3	参考温度 ± 2															
4	125 ± 3															
5	参考温度 ± 2															
10	端子结合强度	不应出现端子脱落或其它缺陷。		<p>使用共晶锡将电容器焊接在图1中所示的测试夹具 (玻璃环氧树脂板) 上。然后平行于测试夹具施加5N*的力10 ± 1秒。焊接应利用烙铁或使用回流焊接方式进行, 而且应谨慎作业, 以使焊接均匀且不会由于热冲击产生缺陷。 *2N (GJM03)</p>  <table border="1"> <thead> <tr> <th>型号</th> <th>a</th> <th>b</th> <th>c</th> </tr> </thead> <tbody> <tr> <td>GJM03</td> <td>0.3</td> <td>0.9</td> <td>0.3</td> </tr> <tr> <td>GJM15</td> <td>0.4</td> <td>1.5</td> <td>0.5</td> </tr> </tbody> </table> <p>(in mm)</p> <p>图1</p>	型号	a	b	c	GJM03	0.3	0.9	0.3	GJM15	0.4	1.5	0.5
型号	a	b	c													
GJM03	0.3	0.9	0.3													
GJM15	0.4	1.5	0.5													
11	振荡电阻	外观	无缺陷或异常	按照与 (10) 相同的方法和条件, 将电容器焊接在测试夹具 (玻璃环氧树脂板) 上。 电容器应进行简谐运动, 其总幅值为1.5mm, 频率在近似10至55Hz之间均匀变化。 频率范围 (从10至55Hz再返回10Hz) 应在约1分钟内完成。振动应在3个相互垂直方向各进行2小时 (总计6小时)。												
		静电容量	在规定偏差范围内													
		Q	30pF及以上: $Q \geq 1000$ 30pF及以下: $Q \geq 400 + 20C$ C: 标称静电容量 (pF)													

接下页。 

GJM系列规格和测试方法

☐ 接上页。

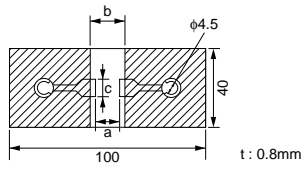
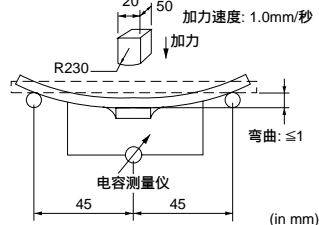
编号	项目	特性		测试方法												
		温度补偿型														
12	外观	无明显缺陷		使用共晶锡将电容器焊接在图2中所示的测试夹具(玻璃环氧树脂板)上。 然后在图3所示的方向加力。 焊接应使用回流焊接方法进行,而且应谨慎作业,以使焊接均匀且不会由于热冲击产生缺陷。												
	静电容量变化	在±5%或±0.5pF(以较大者为准)范围内														
12	弯曲强度	 <table border="1" data-bbox="367 582 877 683"> <thead> <tr> <th>型号</th> <th>a</th> <th>b</th> <th>c</th> </tr> </thead> <tbody> <tr> <td>GJM03</td> <td>0.3</td> <td>0.9</td> <td>0.3</td> </tr> <tr> <td>GJM15</td> <td>0.4</td> <td>1.5</td> <td>0.5</td> </tr> </tbody> </table> <p>(in mm)</p>		型号	a	b	c	GJM03	0.3	0.9	0.3	GJM15	0.4	1.5	0.5	 <p>(in mm)</p>
	型号	a	b	c												
GJM03	0.3	0.9	0.3													
GJM15	0.4	1.5	0.5													
13	端子可焊性	75%端子需均匀且连续焊接。		将电容器浸泡在乙醇(JIS-K-8101)和松香(JIS-K-5902)(松香占25%的重量)溶液中。 在80至120°C范围内预热10至30秒。预热后,再浸泡在230±5°C的共晶锡溶液2±0.5秒或在245±5°C的Sn-3.0Ag-0.5Cu无铅焊锡溶液2±0.5秒。												
14	测量及观测到的特性应满足下表规定。		在120°C至150°C范围内预热电容器1分钟。 将电容器浸泡在270±5°C的共晶锡溶液或Sn-3.0Ag-0.5Cu无铅焊锡溶液10±0.5秒。在常温下放置24±2小时,然后进行测量。													
	外观	无明显缺陷														
	静电容量变化	在±2.5%或±0.25pF(以较大者为准)范围内														
	Q	30pF及以上: Q≥1000 30pF及以下: Q≥400+20C C: 标称静电容量(pF)														
	绝缘电阻	大于10,000MΩ或500Ω·F(以较小者为准)														
15	测量及观测到的特性应满足下表规定。		按照与(10)相同的方法和条件,将电容器固定在支撑夹具上。 按照下表中列出的4种热处理方法执行5个周期。 在常温下放置24±2小时,然后进行测量。													
	外观	无明显缺陷														
	静电容量变化	在±2.5%或±0.25pF(以较大者为准)范围内														
	Q	30pF及以上: Q≥1000 30pF及以下: Q≥400+20C C: 标称静电容量(pF)														
	绝缘电阻	大于10,000MΩ或500Ω·F(以较小者为准)														
16	测量及观测到的特性应满足下表规定。		将电容器在40±2°C及90至95%湿度条件下放置500±12小时。 在常温下放置24±2小时(温度补偿型),然后进行测量。													
	外观	无明显缺陷														
	静电容量变化	在±5%或±0.5pF(以较大者为准)范围内														
	Q	30pF及以下: Q≥350 10pF及以上, 30pF及以下: Q≥275+5/2C 10pF及以下: Q≥200+10C C: 标称静电容量(pF)														
	绝缘电阻	大于10,000MΩ或500Ω·F(以较小者为准)														
17	测量及观测到的特性应满足下表规定。		在40±2°C及90至95%湿度条件下施加额定电压500±12小时。 撤到常温下放置24±2小时,然后进行测量。充电/放电电流低于50mA。													
	外观	无明显缺陷														
	静电容量变化	在±7.5%或±0.75pF(以较大者为准)范围内														
	Q	30pF及以上: Q≥200 30pF及以下: Q≥100+10/3C C: 标称静电容量(pF)														
	绝缘电阻	大于500MΩ或25Ω·F(以较小者为准)														

☐ 接下页。

GJM系列规格和测试方法

☐ 接上页。

编号	项目	特性		测试方法	
		温度补偿型			
18	高温负荷	测量及观测到的特性应满足下表规定。		在最高动作温度 $\pm 3^{\circ}\text{C}$ 条件下施加200%额定电压 1000 ± 12 小时。在常温下放置 24 ± 2 小时(温度补偿型)，然后进行测量。充电/放电电流低于50mA。	
		外观	无明显缺陷		
		静电容量变化	在 $\pm 3\%$ 或 $\pm 0.3\text{pF}$ (以较大者为准)范围内		
		Q	30pF及以上: $Q \geq 350$ 10pF及以上, 30pF及以下: $Q \geq 275 + 5/2C$ 10pF及以下: $Q \geq 200 + 10C$ C: 标称静电容量(pF)		
	绝缘电阻	大于 $1,000\text{M}\Omega$ 或 $50\Omega \cdot \text{F}$ (以较小者为准)			
19	ESR	$0.1\text{pF} \leq C \leq 1\text{pF}$: $350\text{m}\Omega \cdot \text{pF}$ 以下 $1\text{pF} < C \leq 5\text{pF}$: $300\text{m}\Omega$ 以下 $5\text{pF} < C \leq 10\text{pF}$: $250\text{m}\Omega$ 以下		ESR应在常温及 $1 \pm 0.2\text{GHz}$ 频率条件(与BOONTON型号34A相当)下测量。	
		$10\text{pF} < C \leq 33\text{pF}$: $400\text{m}\Omega$ 以下		ESR应在常温及 $500 \pm 50\text{MHz}$ 频率条件(与HP8753B相当)下测量。	

表A

(1)

特性代号	温度系数 (ppm/ $^{\circ}\text{C}$) *1	与25 $^{\circ}\text{C}$ 时静电容量值相比的变化(%)					
		- 55 $^{\circ}\text{C}$		- 30 $^{\circ}\text{C}$		- 10 $^{\circ}\text{C}$	
		最大	最小	最大	最小	最大	最小
5C	0 ± 30	0.58	- 0.24	0.40	- 0.17	0.25	- 0.11
6C	0 ± 60	0.87	- 0.48	0.60	- 0.33	0.38	- 0.21

*1: 标称值表示在25至125 $^{\circ}\text{C}$ 范围内的温度系数。

(2)

特性代号	标称值 (ppm/ $^{\circ}\text{C}$) *2	与20 $^{\circ}\text{C}$ 时静电容量值相比的变化(%)					
		- 55 $^{\circ}\text{C}$		- 25 $^{\circ}\text{C}$		- 10 $^{\circ}\text{C}$	
		最大	最小	最大	最小	最大	最小
2C	0 ± 60	0.82	- 0.45	0.49	- 0.27	0.33	- 0.18
3C	0 ± 120	1.37	- 0.90	0.82	- 0.54	0.55	- 0.36
4C	0 ± 250	2.56	- 1.88	1.54	- 1.13	1.02	- 0.75

*2: 标称值表示在20至125 $^{\circ}\text{C}$ 范围内的温度系数。

片状独石陶瓷电容器



高频型GQM系列

特点

1. VHF、UHF、微波时HiQ和低ESR
2. 提高移动通信设备的功能，降低其功耗（基站、终端等）。

用途

高频电路（移动通信设备）用

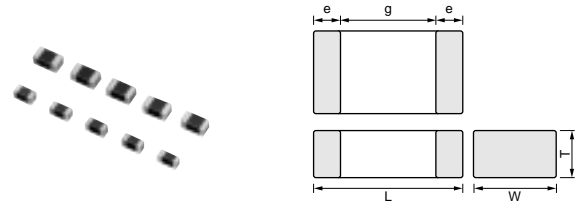

Part Number	Dimensions (mm)				
	L	W	T	e	g min.
GQM187	1.6 ±0.15	0.8 ±0.15	0.7 ±0.1	0.2 to 0.5	0.5
GQM188	1.6 ±0.1	0.8 ±0.1	0.8 ±0.1	0.2 to 0.5	0.5
GQM219 (50,100V)	2.0 ±0.1	1.25 ±0.1	0.85 ±0.1	0.2 to 0.7	0.7
GQM219 (250V)	2.0 ±0.15	1.25 ±0.15	0.85 ±0.15	0.2 to 0.7	0.7

5

电容表

温度补偿型 C0G(5C) 特性

静电容量	TC代号	C0G(5C)						
		长x宽 [mm]	1.6x0.8 (18) <0603>			2.0x1.25 (21) <0805>		
			250 (2E)	100 (2A)	50 (1H)	250 (2E)	100 (2A)	50 (1H)
0.10pF(R10)	7							
0.20pF(R20)	7							
0.30pF(R30)	7							
0.40pF(R40)	7							
0.50pF(R50)	7	8			9	9		
0.75pF(R75)	7	8			9	9		
1.0pF(1R0)	7	8			9	9		
1.1pF(1R1)	7	8			9	9		
1.2pF(1R2)	7	8			9	9		
1.3pF(1R3)	7	8			9	9		
1.5pF(1R5)	7	8			9	9		
1.6pF(1R6)	7	8			9	9		
1.8pF(1R8)	7	8			9	9		
2.0pF(2R0)	7	8			9	9		
2.2pF(2R2)	7	8			9	9		
2.4pF(2R4)	7	8			9	9		
2.7pF(2R7)	7	8			9	9		
3.0pF(3R0)	7	8			9	9		
3.3pF(3R3)	7	8			9	9		
3.6pF(3R6)	7	8			9	9		
3.9pF(3R9)	7	8			9	9		
4.0pF(4R0)	7	8			9	9		
4.3pF(4R3)	7	8			9	9		
4.7pF(4R7)	7	8			9	9		
5.0pF(5R0)	7	8			9	9		
5.1pF(5R1)	7	8			9	9		
5.6pF(5R6)	7	8			9	9		
6.0pF(6R0)	7	8			9	9		
6.2pF(6R2)	7	8			9	9		
6.8pF(6R8)	7	8			9	9		
7.0pF(7R0)	7		8		9	9		

静电容量	TC代号	C0G(5C)						
		长x宽 [mm]	1.6x0.8 (18) <0603>			2.0x1.25 (21) <0805>		
			250 (2E)	100 (2A)	50 (1H)	250 (2E)	100 (2A)	50 (1H)
7.5pF(7R5)	7				8	9	9	
8.0pF(8R0)	7				8	9	9	
8.2pF(8R2)	7				8	9	9	
9.0pF(9R0)	7				8	9	9	
9.1pF(9R1)	7				8	9	9	
10pF(100)	7				8	9	9	
11pF(110)	7				8	9	9	
12pF(120)	7				8	9	9	
13pF(130)	7				8	9	9	
15pF(150)	7				8	9	9	
16pF(160)	7				8	9	9	
18pF(180)	7				8	9	9	
20pF(200)	7				8	9	9	
22pF(220)	7				8	9	9	
24pF(240)	7				8	9	9	
27pF(270)	7				8	9	9	
30pF(300)	7				8	9	9	
33pF(330)	7				8	9	9	
36pF(360)	7				8	9	9	
39pF(390)	7				8	9	9	
43pF(430)	7				8	9	9	
47pF(470)	7				8	9	9	
51pF(510)					8	9	9	
56pF(560)					8	9	9	
62pF(620)					8	9	9	
68pF(680)					8	9	9	
75pF(750)					8	9	9	
82pF(820)					8	9	9	
91pF(910)					8	9	9	
100pF(101)					8	9	9	

品名代号在()中注明，单位在 []中注明。 < >: EIA [英寸] 代号

温度补偿型 C0G(5C) 特性

长x宽 [mm]		1.6x0.8(18)<0603>	
额定电压 [Vdc]		250(2E)	100(2A)
静电容量	公差	品名	
0.10pF(R10)	±0.1pF(B)	GQM1875C2ER10BB12D	
0.20pF(R20)	±0.1pF(B)	GQM1875C2ER20BB12D	
0.30pF(R30)	±0.1pF(B)	GQM1875C2ER30BB12D	
	±0.25pF(C)	GQM1875C2ER30CB12D	
0.40pF(R40)	±0.1pF(B)	GQM1875C2ER40BB12D	
	±0.25pF(C)	GQM1875C2ER40CB12D	
0.50pF(R50)	±0.1pF(B)	GQM1875C2ER50BB12D	GQM1885C2AR50BB01D
	±0.25pF(C)	GQM1875C2ER50CB12D	GQM1885C2AR50CB01D
0.75pF(R75)	±0.1pF(B)	GQM1875C2ER75BB12D	GQM1885C2AR75BB01D
	±0.25pF(C)	GQM1875C2ER75CB12D	GQM1885C2AR75CB01D
1.0pF(1R0)	±0.1pF(B)	GQM1875C2E1R0BB12D	GQM1885C2A1R0BB01D
	±0.25pF(C)	GQM1875C2E1R0CB12D	GQM1885C2A1R0CB01D
1.1pF(1R1)	±0.1pF(B)	GQM1875C2E1R1BB12D	GQM1885C2A1R1BB01D
	±0.25pF(C)	GQM1875C2E1R1CB12D	GQM1885C2A1R1CB01D
1.2pF(1R2)	±0.1pF(B)	GQM1875C2E1R2BB12D	GQM1885C2A1R2BB01D
	±0.25pF(C)	GQM1875C2E1R2CB12D	GQM1885C2A1R2CB01D
1.3pF(1R3)	±0.1pF(B)	GQM1875C2E1R3BB12D	GQM1885C2A1R3BB01D
	±0.25pF(C)	GQM1875C2E1R3CB12D	GQM1885C2A1R3CB01D
1.5pF(1R5)	±0.1pF(B)	GQM1875C2E1R5BB12D	GQM1885C2A1R5BB01D
	±0.25pF(C)	GQM1875C2E1R5CB12D	GQM1885C2A1R5CB01D
1.6pF(1R6)	±0.1pF(B)	GQM1875C2E1R6BB12D	GQM1885C2A1R6BB01D
	±0.25pF(C)	GQM1875C2E1R6CB12D	GQM1885C2A1R6CB01D
1.8pF(1R8)	±0.1pF(B)	GQM1875C2E1R8BB12D	GQM1885C2A1R8BB01D
	±0.25pF(C)	GQM1875C2E1R8CB12D	GQM1885C2A1R8CB01D
2.0pF(2R0)	±0.1pF(B)	GQM1875C2E2R0BB12D	GQM1885C2A2R0BB01D
	±0.25pF(C)	GQM1875C2E2R0CB12D	GQM1885C2A2R0CB01D
2.2pF(2R2)	±0.1pF(B)	GQM1875C2E2R2BB12D	GQM1885C2A2R2BB01D
	±0.25pF(C)	GQM1875C2E2R2CB12D	GQM1885C2A2R2CB01D
2.4pF(2R4)	±0.1pF(B)	GQM1875C2E2R4BB12D	GQM1885C2A2R4BB01D
	±0.25pF(C)	GQM1875C2E2R4CB12D	GQM1885C2A2R4CB01D
2.7pF(2R7)	±0.1pF(B)	GQM1875C2E2R7BB12D	GQM1885C2A2R7BB01D
	±0.25pF(C)	GQM1875C2E2R7CB12D	GQM1885C2A2R7CB01D
3.0pF(3R0)	±0.1pF(B)	GQM1875C2E3R0BB12D	GQM1885C2A3R0BB01D
	±0.25pF(C)	GQM1875C2E3R0CB12D	GQM1885C2A3R0CB01D
3.3pF(3R3)	±0.1pF(B)	GQM1875C2E3R3BB12D	GQM1885C2A3R3BB01D
	±0.25pF(C)	GQM1875C2E3R3CB12D	GQM1885C2A3R3CB01D
3.6pF(3R6)	±0.1pF(B)	GQM1875C2E3R6BB12D	GQM1885C2A3R6BB01D
	±0.25pF(C)	GQM1875C2E3R6CB12D	GQM1885C2A3R6CB01D
3.9pF(3R9)	±0.1pF(B)	GQM1875C2E3R9BB12D	GQM1885C2A3R9BB01D
	±0.25pF(C)	GQM1875C2E3R9CB12D	GQM1885C2A3R9CB01D
4.0pF(4R0)	±0.1pF(B)	GQM1875C2E4R0BB12D	GQM1885C2A4R0BB01D
	±0.25pF(C)	GQM1875C2E4R0CB12D	GQM1885C2A4R0CB01D
4.3pF(4R3)	±0.1pF(B)	GQM1875C2E4R3BB12D	GQM1885C2A4R3BB01D
	±0.25pF(C)	GQM1875C2E4R3CB12D	GQM1885C2A4R3CB01D
4.7pF(4R7)	±0.1pF(B)	GQM1875C2E4R7BB12D	GQM1885C2A4R7BB01D
	±0.25pF(C)	GQM1875C2E4R7CB12D	GQM1885C2A4R7CB01D
5.0pF(5R0)	±0.1pF(B)	GQM1875C2E5R0BB12D	GQM1885C2A5R0BB01D
	±0.25pF(C)	GQM1875C2E5R0CB12D	GQM1885C2A5R0CB01D

品名代号在()中注明，单位在 []中注明。< >: EIA [英寸] 代号

- (品名) **GQ** **M** **18** **7** **5C** **2E** **R10** **B** **B12** **D** ①型号 ②系列 ③尺寸(长×宽) ④尺寸(厚度) ⑤温度特性
 ⑥额定电压 ⑦静电容量 ⑧静电容量公差 ⑨个别规格代号 ⑩包装

品名中的包装代号表示标准180mm卷盘。

温度补偿型 C0G(5C) 特性

长x宽 [mm]		1.6x0.8(18)<0603>		
额定电压 [Vdc]		250(2E)	100(2A)	50(1H)
静电容量	公差	品名		
5.1pF(5R1)	±0.25pF(C)	GQM1875C2E5R1CB12D	GQM1885C2A5R1CB01D	
	±0.5pF(D)	GQM1875C2E5R1DB12D	GQM1885C2A5R1DB01D	
5.6pF(5R6)	±0.25pF(C)	GQM1875C2E5R6CB12D	GQM1885C2A5R6CB01D	
	±0.5pF(D)	GQM1875C2E5R6DB12D	GQM1885C2A5R6DB01D	
6.0pF(6R0)	±0.25pF(C)	GQM1875C2E6R0CB12D	GQM1885C2A6R0CB01D	
	±0.5pF(D)	GQM1875C2E6R0DB12D	GQM1885C2A6R0DB01D	
6.2pF(6R2)	±0.25pF(C)	GQM1875C2E6R2CB12D	GQM1885C2A6R2CB01D	
	±0.5pF(D)	GQM1875C2E6R2DB12D	GQM1885C2A6R2DB01D	
6.8pF(6R8)	±0.25pF(C)	GQM1875C2E6R8CB12D	GQM1885C2A6R8CB01D	
	±0.5pF(D)	GQM1875C2E6R8DB12D	GQM1885C2A6R8DB01D	
7.0pF(7R0)	±0.25pF(C)	GQM1875C2E7R0CB12D		GQM1885C1H7R0CB01D
	±0.5pF(D)	GQM1875C2E7R0DB12D		GQM1885C1H7R0DB01D
7.5pF(7R5)	±0.25pF(C)	GQM1875C2E7R5CB12D		GQM1885C1H7R5CB01D
	±0.5pF(D)	GQM1875C2E7R5DB12D		GQM1885C1H7R5DB01D
8.0pF(8R0)	±0.25pF(C)	GQM1875C2E8R0CB12D		GQM1885C1H8R0CB01D
	±0.5pF(D)	GQM1875C2E8R0DB12D		GQM1885C1H8R0DB01D
8.2pF(8R2)	±0.25pF(C)	GQM1875C2E8R2CB12D		GQM1885C1H8R2CB01D
	±0.5pF(D)	GQM1875C2E8R2DB12D		GQM1885C1H8R2DB01D
9.0pF(9R0)	±0.25pF(C)	GQM1875C2E9R0CB12D		GQM1885C1H9R0CB01D
	±0.5pF(D)	GQM1875C2E9R0DB12D		GQM1885C1H9R0DB01D
9.1pF(9R1)	±0.25pF(C)	GQM1875C2E9R1CB12D		GQM1885C1H9R1CB01D
	±0.5pF(D)	GQM1875C2E9R1DB12D		GQM1885C1H9R1DB01D
10pF(100)	±2%(G)	GQM1875C2E100GB12D		GQM1885C1H100GB01D
	±5%(J)	GQM1875C2E100JB12D		GQM1885C1H100JB01D
11pF(110)	±2%(G)	GQM1875C2E110GB12D		GQM1885C1H110GB01D
	±5%(J)	GQM1875C2E110JB12D		GQM1885C1H110JB01D
12pF(120)	±2%(G)	GQM1875C2E120GB12D		GQM1885C1H120GB01D
	±5%(J)	GQM1875C2E120JB12D		GQM1885C1H120JB01D
13pF(130)	±2%(G)	GQM1875C2E130GB12D		GQM1885C1H130GB01D
	±5%(J)	GQM1875C2E130JB12D		GQM1885C1H130JB01D
15pF(150)	±2%(G)	GQM1875C2E150GB12D		GQM1885C1H150GB01D
	±5%(J)	GQM1875C2E150JB12D		GQM1885C1H150JB01D
16pF(160)	±2%(G)	GQM1875C2E160GB12D		GQM1885C1H160GB01D
	±5%(J)	GQM1875C2E160JB12D		GQM1885C1H160JB01D
18pF(180)	±2%(G)	GQM1875C2E180GB12D		GQM1885C1H180GB01D
	±5%(J)	GQM1875C2E180JB12D		GQM1885C1H180JB01D
20pF(200)	±2%(G)	GQM1875C2E200GB12D		GQM1885C1H200GB01D
	±5%(J)	GQM1875C2E200JB12D		GQM1885C1H200JB01D
22pF(220)	±2%(G)	GQM1875C2E220GB12D		GQM1885C1H220GB01D
	±5%(J)	GQM1875C2E220JB12D		GQM1885C1H220JB01D
24pF(240)	±2%(G)	GQM1875C2E240GB12D		GQM1885C1H240GB01D
	±5%(J)	GQM1875C2E240JB12D		GQM1885C1H240JB01D
27pF(270)	±2%(G)	GQM1875C2E270GB12D		GQM1885C1H270GB01D
	±5%(J)	GQM1875C2E270JB12D		GQM1885C1H270JB01D
30pF(300)	±2%(G)	GQM1875C2E300GB12D		GQM1885C1H300GB01D
	±5%(J)	GQM1875C2E300JB12D		GQM1885C1H300JB01D

品名代号在()中注明，单位在 []中注明。< >: EIA [英寸] 代号

温度补偿型 C0G(5C) 特性

长x宽 [mm]		1.6x0.8(18)<0603>	
额定电压 [Vdc]		250(2E)	50(1H)
静电容量	公差	品名	
33pF(330)	±2%(G)	GQM1875C2E330GB12D	GQM1885C1H330GB01D
	±5%(J)	GQM1875C2E330JB12D	GQM1885C1H330JB01D
36pF(360)	±2%(G)	GQM1875C2E360GB12D	GQM1885C1H360GB01D
	±5%(J)	GQM1875C2E360JB12D	GQM1885C1H360JB01D
39pF(390)	±2%(G)	GQM1875C2E390GB12D	GQM1885C1H390GB01D
	±5%(J)	GQM1875C2E390JB12D	GQM1885C1H390JB01D
43pF(430)	±2%(G)	GQM1875C2E430GB12D	GQM1885C1H430GB01D
	±5%(J)	GQM1875C2E430JB12D	GQM1885C1H430JB01D
47pF(470)	±2%(G)	GQM1875C2E470GB12D	GQM1885C1H470GB01D
	±5%(J)	GQM1875C2E470JB12D	GQM1885C1H470JB01D
51pF(510)	±2%(G)		GQM1885C1H510GB01D
	±5%(J)		GQM1885C1H510JB01D
56pF(560)	±2%(G)		GQM1885C1H560GB01D
	±5%(J)		GQM1885C1H560JB01D
62pF(620)	±2%(G)		GQM1885C1H620GB01D
	±5%(J)		GQM1885C1H620JB01D
68pF(680)	±2%(G)		GQM1885C1H680GB01D
	±5%(J)		GQM1885C1H680JB01D
75pF(750)	±2%(G)		GQM1885C1H750GB01D
	±5%(J)		GQM1885C1H750JB01D
82pF(820)	±2%(G)		GQM1885C1H820GB01D
	±5%(J)		GQM1885C1H820JB01D
91pF(910)	±2%(G)		GQM1885C1H910GB01D
	±5%(J)		GQM1885C1H910JB01D
100pF(101)	±2%(G)		GQM1885C1H101GB01D
	±5%(J)		GQM1885C1H101JB01D

品名代号在()中注明，单位在 []中注明。< >: EIA [英寸] 代号

(品名) **GQ** **M** **18** **7** **5C** **2E** **330** **G** **B12** **D**
 ① ② ③ ④ ⑤ ⑥ ⑦ ⑧ ⑨ ⑩

① 型号

② 系列

③ 尺寸 (长 × 宽)

④ 尺寸 (厚度)

⑤ 温度特性

⑥ 额定电压

⑦ 静电容量

⑧ 静电容量公差

⑨ 个别规格代号

⑩ 包装

品名中的包装代号表示标准180mm卷盘。

温度补偿型 C0G(5C) 特性

长x宽 [mm]		2.0x1.25(21)<0805>	
额定电压 [Vdc]		250(2E)	100(2A)
静电容量	公差	品名	
0.50pF(R50)	±0.1pF(B)	GQM2195C2ER50BB12D	GQM2195C2AR50BB01D
	±0.25pF(C)	GQM2195C2ER50CB12D	GQM2195C2AR50CB01D
0.75pF(R75)	±0.1pF(B)	GQM2195C2ER75BB12D	GQM2195C2AR75BB01D
	±0.25pF(C)	GQM2195C2ER75CB12D	GQM2195C2AR75CB01D
1.0pF(1R0)	±0.1pF(B)	GQM2195C2E1R0BB12D	GQM2195C2A1R0BB01D
	±0.25pF(C)	GQM2195C2E1R0CB12D	GQM2195C2A1R0CB01D
1.1pF(1R1)	±0.1pF(B)	GQM2195C2E1R1BB12D	GQM2195C2A1R1BB01D
	±0.25pF(C)	GQM2195C2E1R1CB12D	GQM2195C2A1R1CB01D
1.2pF(1R2)	±0.1pF(B)	GQM2195C2E1R2BB12D	GQM2195C2A1R2BB01D
	±0.25pF(C)	GQM2195C2E1R2CB12D	GQM2195C2A1R2CB01D
1.3pF(1R3)	±0.1pF(B)	GQM2195C2E1R3BB12D	GQM2195C2A1R3BB01D
	±0.25pF(C)	GQM2195C2E1R3CB12D	GQM2195C2A1R3CB01D
1.5pF(1R5)	±0.1pF(B)	GQM2195C2E1R5BB12D	GQM2195C2A1R5BB01D
	±0.25pF(C)	GQM2195C2E1R5CB12D	GQM2195C2A1R5CB01D
1.6pF(1R6)	±0.1pF(B)	GQM2195C2E1R6BB12D	GQM2195C2A1R6BB01D
	±0.25pF(C)	GQM2195C2E1R6CB12D	GQM2195C2A1R6CB01D
1.8pF(1R8)	±0.1pF(B)	GQM2195C2E1R8BB12D	GQM2195C2A1R8BB01D
	±0.25pF(C)	GQM2195C2E1R8CB12D	GQM2195C2A1R8CB01D
2.0pF(2R0)	±0.1pF(B)	GQM2195C2E2R0BB12D	GQM2195C2A2R0BB01D
	±0.25pF(C)	GQM2195C2E2R0CB12D	GQM2195C2A2R0CB01D
2.2pF(2R2)	±0.1pF(B)	GQM2195C2E2R2BB12D	GQM2195C2A2R2BB01D
	±0.25pF(C)	GQM2195C2E2R2CB12D	GQM2195C2A2R2CB01D
2.4pF(2R4)	±0.1pF(B)	GQM2195C2E2R4BB12D	GQM2195C2A2R4BB01D
	±0.25pF(C)	GQM2195C2E2R4CB12D	GQM2195C2A2R4CB01D
2.7pF(2R7)	±0.1pF(B)	GQM2195C2E2R7BB12D	GQM2195C2A2R7BB01D
	±0.25pF(C)	GQM2195C2E2R7CB12D	GQM2195C2A2R7CB01D
3.0pF(3R0)	±0.1pF(B)	GQM2195C2E3R0BB12D	GQM2195C2A3R0BB01D
	±0.25pF(C)	GQM2195C2E3R0CB12D	GQM2195C2A3R0CB01D
3.3pF(3R3)	±0.1pF(B)	GQM2195C2E3R3BB12D	GQM2195C2A3R3BB01D
	±0.25pF(C)	GQM2195C2E3R3CB12D	GQM2195C2A3R3CB01D
3.6pF(3R6)	±0.1pF(B)	GQM2195C2E3R6BB12D	GQM2195C2A3R6BB01D
	±0.25pF(C)	GQM2195C2E3R6CB12D	GQM2195C2A3R6CB01D
3.9pF(3R9)	±0.1pF(B)	GQM2195C2E3R9BB12D	GQM2195C2A3R9BB01D
	±0.25pF(C)	GQM2195C2E3R9CB12D	GQM2195C2A3R9CB01D
4.0pF(4R0)	±0.1pF(B)	GQM2195C2E4R0BB12D	GQM2195C2A4R0BB01D
	±0.25pF(C)	GQM2195C2E4R0CB12D	GQM2195C2A4R0CB01D
4.3pF(4R3)	±0.1pF(B)	GQM2195C2E4R3BB12D	GQM2195C2A4R3BB01D
	±0.25pF(C)	GQM2195C2E4R3CB12D	GQM2195C2A4R3CB01D
4.7pF(4R7)	±0.1pF(B)	GQM2195C2E4R7BB12D	GQM2195C2A4R7BB01D
	±0.25pF(C)	GQM2195C2E4R7CB12D	GQM2195C2A4R7CB01D
5.0pF(5R0)	±0.1pF(B)	GQM2195C2E5R0BB12D	GQM2195C2A5R0BB01D
	±0.25pF(C)	GQM2195C2E5R0CB12D	GQM2195C2A5R0CB01D
5.1pF(5R1)	±0.25pF(C)	GQM2195C2E5R1CB12D	GQM2195C2A5R1CB01D
	±0.5pF(D)	GQM2195C2E5R1DB12D	GQM2195C2A5R1DB01D
5.6pF(5R6)	±0.25pF(C)	GQM2195C2E5R6CB12D	GQM2195C2A5R6CB01D
	±0.5pF(D)	GQM2195C2E5R6DB12D	GQM2195C2A5R6DB01D
6.0pF(6R0)	±0.25pF(C)	GQM2195C2E6R0CB12D	GQM2195C2A6R0CB01D
	±0.5pF(D)	GQM2195C2E6R0DB12D	GQM2195C2A6R0DB01D

品名代号在()中注明，单位在[]中注明。< >: EIA [英寸] 代号

温度补偿型 C0G(5C) 特性

长x宽 [mm]		2.0x1.25(21)<0805>		
额定电压 [Vdc]		250(2E)	100(2A)	50(1H)
静电容量	公差	品名		
6.2pF(6R2)	±0.25pF(C)	GQM2195C2E6R2CB12D	GQM2195C2A6R2CB01D	
	±0.5pF(D)	GQM2195C2E6R2DB12D	GQM2195C2A6R2DB01D	
6.8pF(6R8)	±0.25pF(C)	GQM2195C2E6R8CB12D	GQM2195C2A6R8CB01D	
	±0.5pF(D)	GQM2195C2E6R8DB12D	GQM2195C2A6R8DB01D	
7.0pF(7R0)	±0.25pF(C)	GQM2195C2E7R0CB12D	GQM2195C2A7R0CB01D	
	±0.5pF(D)	GQM2195C2E7R0DB12D	GQM2195C2A7R0DB01D	
7.5pF(7R5)	±0.25pF(C)	GQM2195C2E7R5CB12D	GQM2195C2A7R5CB01D	
	±0.5pF(D)	GQM2195C2E7R5DB12D	GQM2195C2A7R5DB01D	
8.0pF(8R0)	±0.25pF(C)	GQM2195C2E8R0CB12D	GQM2195C2A8R0CB01D	
	±0.5pF(D)	GQM2195C2E8R0DB12D	GQM2195C2A8R0DB01D	
8.2pF(8R2)	±0.25pF(C)	GQM2195C2E8R2CB12D	GQM2195C2A8R2CB01D	
	±0.5pF(D)	GQM2195C2E8R2DB12D	GQM2195C2A8R2DB01D	
9.0pF(9R0)	±0.25pF(C)	GQM2195C2E9R0CB12D	GQM2195C2A9R0CB01D	
	±0.5pF(D)	GQM2195C2E9R0DB12D	GQM2195C2A9R0DB01D	
9.1pF(9R1)	±0.25pF(C)	GQM2195C2E9R1CB12D	GQM2195C2A9R1CB01D	
	±0.5pF(D)	GQM2195C2E9R1DB12D	GQM2195C2A9R1DB01D	
10pF(100)	±2%(G)	GQM2195C2E100GB12D	GQM2195C2A100GB01D	
	±5%(J)	GQM2195C2E100JB12D	GQM2195C2A100JB01D	
11pF(110)	±2%(G)	GQM2195C2E110GB12D	GQM2195C2A110GB01D	
	±5%(J)	GQM2195C2E110JB12D	GQM2195C2A110JB01D	
12pF(120)	±2%(G)	GQM2195C2E120GB12D	GQM2195C2A120GB01D	
	±5%(J)	GQM2195C2E120JB12D	GQM2195C2A120JB01D	
13pF(130)	±2%(G)	GQM2195C2E130GB12D	GQM2195C2A130GB01D	
	±5%(J)	GQM2195C2E130JB12D	GQM2195C2A130JB01D	
15pF(150)	±2%(G)	GQM2195C2E150GB12D	GQM2195C2A150GB01D	
	±5%(J)	GQM2195C2E150JB12D	GQM2195C2A150JB01D	
16pF(160)	±2%(G)	GQM2195C2E160GB12D	GQM2195C2A160GB01D	
	±5%(J)	GQM2195C2E160JB12D	GQM2195C2A160JB01D	
18pF(180)	±2%(G)	GQM2195C2E180GB12D	GQM2195C2A180GB01D	
	±5%(J)	GQM2195C2E180JB12D	GQM2195C2A180JB01D	
20pF(200)	±2%(G)	GQM2195C2E200GB12D		GQM2195C1H200GB01D
	±5%(J)	GQM2195C2E200JB12D		GQM2195C1H200JB01D
22pF(220)	±2%(G)	GQM2195C2E220GB12D		GQM2195C1H220GB01D
	±5%(J)	GQM2195C2E220JB12D		GQM2195C1H220JB01D
24pF(240)	±2%(G)	GQM2195C2E240GB12D		GQM2195C1H240GB01D
	±5%(J)	GQM2195C2E240JB12D		GQM2195C1H240JB01D
27pF(270)	±2%(G)	GQM2195C2E270GB12D		GQM2195C1H270GB01D
	±5%(J)	GQM2195C2E270JB12D		GQM2195C1H270JB01D
30pF(300)	±2%(G)	GQM2195C2E300GB12D		GQM2195C1H300GB01D
	±5%(J)	GQM2195C2E300JB12D		GQM2195C1H300JB01D
33pF(330)	±2%(G)	GQM2195C2E330GB12D		GQM2195C1H330GB01D
	±5%(J)	GQM2195C2E330JB12D		GQM2195C1H330JB01D
36pF(360)	±2%(G)	GQM2195C2E360GB12D		GQM2195C1H360GB01D
	±5%(J)	GQM2195C2E360JB12D		GQM2195C1H360JB01D
39pF(390)	±2%(G)	GQM2195C2E390GB12D		GQM2195C1H390GB01D
	±5%(J)	GQM2195C2E390JB12D		GQM2195C1H390JB01D

品名代号在()中注明，单位在 []中注明。< >: EIA [英寸] 代号

- (品名) **GQ** **M** **21** **9** **5C** **2E** **6R2** **C** **B12** **D** ①型号 ②系列 ③尺寸(长×宽) ④尺寸(厚度) ⑤温度特性
 ⑥额定电压 ⑦静电容量 ⑧静电容量公差 ⑨个别规格代号 ⑩包装

品名中的包装代号表示标准180mm卷盘。

温度补偿型 C0G(5C) 特性

长x宽 [mm]		2.0x1.25(21)<0805>	
额定电压 [Vdc]		250(2E)	50(1H)
静电容量	公差	品名	
43pF(430)	±2%(G)	GQM2195C2E430GB12D	GQM2195C1H430GB01D
	±5%(J)	GQM2195C2E430JB12D	GQM2195C1H430JB01D
47pF(470)	±2%(G)	GQM2195C2E470GB12D	GQM2195C1H470GB01D
	±5%(J)	GQM2195C2E470JB12D	GQM2195C1H470JB01D
51pF(510)	±2%(G)	GQM2195C2E510GB12D	GQM2195C1H510GB01D
	±5%(J)	GQM2195C2E510JB12D	GQM2195C1H510JB01D
56pF(560)	±2%(G)	GQM2195C2E560GB12D	GQM2195C1H560GB01D
	±5%(J)	GQM2195C2E560JB12D	GQM2195C1H560JB01D
62pF(620)	±2%(G)	GQM2195C2E620GB12D	GQM2195C1H620GB01D
	±5%(J)	GQM2195C2E620JB12D	GQM2195C1H620JB01D
68pF(680)	±2%(G)	GQM2195C2E680GB12D	GQM2195C1H680GB01D
	±5%(J)	GQM2195C2E680JB12D	GQM2195C1H680JB01D
75pF(750)	±2%(G)	GQM2195C2E750GB12D	GQM2195C1H750GB01D
	±5%(J)	GQM2195C2E750JB12D	GQM2195C1H750JB01D
82pF(820)	±2%(G)	GQM2195C2E820GB12D	GQM2195C1H820GB01D
	±5%(J)	GQM2195C2E820JB12D	GQM2195C1H820JB01D
91pF(910)	±2%(G)	GQM2195C2E910GB12D	GQM2195C1H910GB01D
	±5%(J)	GQM2195C2E910JB12D	GQM2195C1H910JB01D
100pF(101)	±2%(G)	GQM2195C2E101GB12D	GQM2195C1H101GB01D
	±5%(J)	GQM2195C2E101JB12D	GQM2195C1H101JB01D

品名代号在()中注明，单位在 []中注明。< >: EIA [英寸] 代号

www.tocosc.com

GQM系列规格和测试方法

5

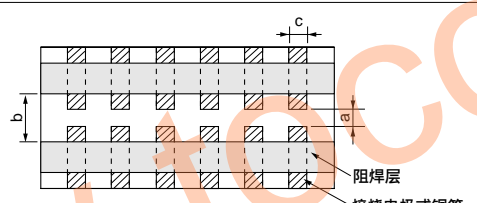
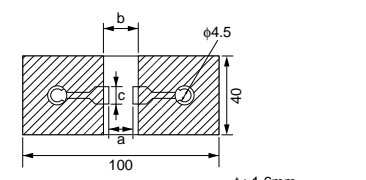
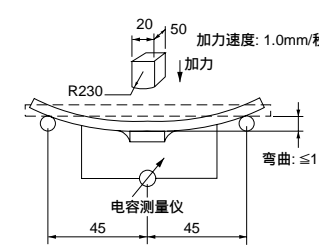
编号	项目	特性	测试方法												
1	动作温度范围	- 55至125°C	参考温度: 25°C												
2	额定电压	参见上页	额定电压定义为可向电容器连续施加的最大电压。 当交流电压附加于直流电压时, V^{P-P} 或 V^{O-P} (以较大者为准) 应维持在额定电压范围内。												
3	外观	无缺陷或异常	目视检查												
4	尺寸	在规定尺寸范围内	使用游标卡尺												
5	介电强度	无缺陷或异常	在端子间施加300% *额定电压1至5秒时不应观察到任何故障, 并且充电/放电电流低于50mA。 *250V仅限250%												
6	绝缘电阻	大于10,000MΩ	绝缘电阻应在25°C且最大相对湿度为75%条件下用不超过额定电压的直流电压测量, 时间应选在充电开始后2分钟内。												
7	静电容量	在规定偏差范围内	静电容量/Q值应在25°C条件下, 按表内的频率及电压测量。												
8	Q	最小30pF: $Q \geq 1400$ 最大30pF: $Q \geq 800 + 20C$ C: 标称静电容量 (pF)	<table border="1" style="width: 100%; border-collapse: collapse;"> <tr> <td style="text-align: center;">频率</td> <td style="text-align: center;">1 ± 0.1MHz</td> </tr> <tr> <td style="text-align: center;">电压</td> <td style="text-align: center;">0.5至5Vrms</td> </tr> </table>	频率	1 ± 0.1MHz	电压	0.5至5Vrms								
频率	1 ± 0.1MHz														
电压	0.5至5Vrms														
9	静电容量温度特性	静电容量变化	温度系数使用在第3阶段中测得的静电容量作为参考来确定。 在依次通过第1至第5阶段的温度时, 静电容量应在表A规定的温度系数和静电容量变化偏差范围内。 静电容量漂移是将在第1、3及5阶段测得的最大和最小值之间的差除以第3阶段的静电容量值计算而得。												
		温度系数													
		静电容量漂移		在 ± 0.2% 或 ± 0.05pF (以较大者为准) 范围内											
10	端子结合强度	不应出现端子脱落或其它缺陷	使用共晶锡将电容器焊接在图1中所示的测试夹具 (玻璃环氧树脂板) 上。然后平行于测试夹具施加10N*的力10 ± 1秒。 焊接应利用烙铁或使用回流焊接方法进行, 而且应谨慎作业, 以使焊接均匀且不会由于热冲击产生缺陷。 *5N (GQM188)												
															
		<table border="1" style="width: 100%; border-collapse: collapse;"> <thead> <tr> <th>型号</th> <th>a</th> <th>b</th> <th>c</th> </tr> </thead> <tbody> <tr> <td>GQM18</td> <td>1.0</td> <td>3.0</td> <td>1.2</td> </tr> <tr> <td>GQM21</td> <td>1.2</td> <td>4.0</td> <td>1.65</td> </tr> </tbody> </table> (in mm)		型号	a	b	c	GQM18	1.0	3.0	1.2	GQM21	1.2	4.0	1.65
型号	a	b	c												
GQM18	1.0	3.0	1.2												
GQM21	1.2	4.0	1.65												
		图1													
11	振荡电阻	外观	按照与 (10) 相同的方法和条件, 将电容器焊接在测试夹具 (玻璃环氧树脂板) 上。 电容器应进行简谐运动, 其总幅值为1.5mm, 频率在近似10至55Hz之间均匀变化。频率范围 (从10至55Hz再返回10Hz) 应在约1分钟内完成。 振动应在3个相互垂直方向各进行2小时 (总计6小时)。												
		静电容量													
12	弯曲强度	外观	使用共晶锡将电容器焊接在图2中所示的测试夹具 (玻璃环氧树脂板) 上。 然后在图3所示的方向加力。 焊接应使用回流焊接方法进行, 而且应谨慎作业, 以使焊接均匀且不会由于热冲击产生缺陷。												
		静电容量变化													
															
		<table border="1" style="width: 100%; border-collapse: collapse;"> <thead> <tr> <th>型号</th> <th>a</th> <th>b</th> <th>c</th> </tr> </thead> <tbody> <tr> <td>GQM18</td> <td>1.0</td> <td>3.0</td> <td>1.2</td> </tr> <tr> <td>GQM21</td> <td>1.2</td> <td>4.0</td> <td>1.65</td> </tr> </tbody> </table> (in mm)		型号	a	b	c	GQM18	1.0	3.0	1.2	GQM21	1.2	4.0	1.65
型号	a	b	c												
GQM18	1.0	3.0	1.2												
GQM21	1.2	4.0	1.65												
		图2													
															
		图3													
13	端子可焊性	75%端子需均匀且连续焊接。	将电容器浸泡在乙醇 (JIS-K-8101) 和松香 (JIS-K-5902) (松香占25%的重量) 溶液中。 在80至120°C范围内预热10至30秒。预热后, 再浸泡在230 ± 5°C的共晶锡溶液2 ± 0.5秒或在245 ± 5°C的Sn-3.0Ag-0.5Cu无铅焊锡溶液2 ± 0.5秒。												

接下页。

GQM系列规格和测试方法

接上页。

编号	项目	特性	测试方法	
14	耐焊热性	测量及观测到的特性应满足下表规定。	在120°C至150°C范围内预热电容器1分钟。 将电容器浸泡在270 ± 5°C的共晶锡溶液或Sn-3.0Ag-0.5Cu无铅焊锡溶液10 ± 0.5秒。在常温下放置24 ± 2小时。	
		外观		无明显缺陷
		静电容量变化		在 ± 2.5%或 ± 0.25 pF (以较大者为准) 范围内
		Q		最小30pF: Q ≥ 1400 最大30pF: Q ≥ 800 + 20C C: 标称静电容量 (pF)
		绝缘电阻		大于10,000MΩ
15	温度周期	测量及观测到的特性应满足下表规定。	按照与 (10) 相同的方法和条件，将电容器固定在支撑夹具上。 按照下表中列出的4种热处理方法执行5个周期。 在常温下放置24 ± 2小时，然后进行测量。	
		外观		无明显缺陷
		静电容量变化		在 ± 2.5%或 ± 0.25pF (以较大者为准) 范围内
		Q		最小30pF: Q ≥ 1400 最大30pF: Q ≥ 800 + 20C C: 标称静电容量 (pF)
		绝缘电阻		大于10,000MΩ
16	湿度，稳态	测量及观测到的特性应满足下表规定	将电容器在40 ± 2°C及湿度为90至95%条件下放置500 ± 12小时。 撤到常温下放置24 ± 2小时(温度补偿型)，然后进行测量。	
		外观		无明显缺陷
		静电容量变化		在 ± 5%或 ± 0.5pF (以较大者为准) 范围内
		Q		最小30pF: Q ≥ 350 10pF及以上, 30pF及以下: Q ≥ 275 + 5C/2 最大10pF: Q ≥ 200 + 10C C: 标称静电容量 (pF)
		绝缘电阻		大于1,000MΩ
17	湿度负荷	测量及观测到的特性应满足下表规定。	在40 ± 2°C及90至95%湿度条件下施加额定电压500 ± 12小时。 撤到常温下放置24 ± 2小时，然后进行测量。 充电/放电电流低于50mA。	
		外观		无明显缺陷
		静电容量变化		在 ± 7.5%或 ± 0.75pF (以较大者为准) 范围内
		Q		最小30pF: Q ≥ 200 最大30pF: Q ≥ 100 + 10C/3 C: 标称静电容量 (pF)
		绝缘电阻		大于500MΩ
18	高温负荷	测量及观测到的特性应满足下表规定。	在最高动作温度 ± 3°C条件下施加200%额定电压1,000 ± 12小时。 撤到常温下放置24 ± 2小时(温度补偿型)，然后进行测量。 充电/放电电流低于50mA。	
		外观		无明显缺陷
		静电容量变化		在 ± 3%或 ± 0.3pF (以较大者为准) 范围内
		Q		最小30pF: Q ≥ 350 10pF及以上, 30pF及以下: Q ≥ 275 + 5C/2 最大10pF: Q ≥ 200 + 10C C: 标称静电容量 (pF)
		绝缘电阻		大于1,000MΩ

阶段	1	2	3	4
温度 (°C)	最低动作温度 + 0 / - 3	常温	最高动作温度 + 3 / - 0	常温
时间 (分钟)	30 ± 3	2至3	30 ± 3	2至3

表A

特性代号	标称值 (ppm/°C) *1	与25°C静电容量值相比的变化 (%)					
		- 55°C		- 30°C		- 10°C	
		最大	最小	最大	最小	最大	最小
5C	0 ± 30	0.58	- 0.24	0.40	- 0.17	0.25	- 0.11

*1: 标称值表示在25至125°C范围内的温度系数。

GQM系列数据

■ Q - 频率特性

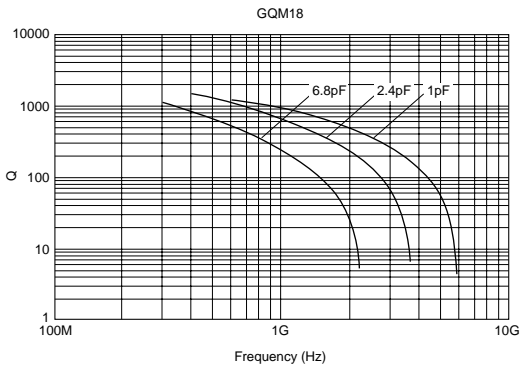

■ 谐振频率 - 静电容量

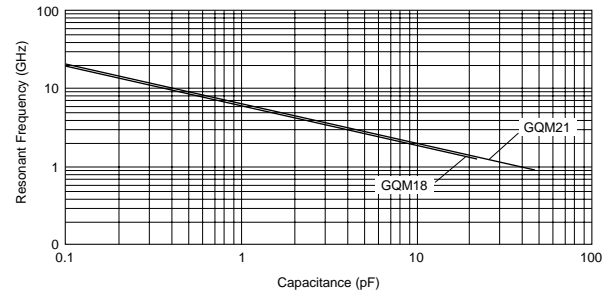

5

www.tocosc.com

片状独石陶瓷电容器



高频型 ERB系列

特点 (ERB系列)

1. 由于其独石构造，其电感极为微小，因此本系列可用于1GHz以上的频率。
2. ERB系列的镀镍端子提高可焊性，同时降低焊料沥滤。
3. ERB18/21系列设计同时适用波峰及回流焊接，而ERB32系列设计适用回流焊接。

用途

高频及大功率电路用

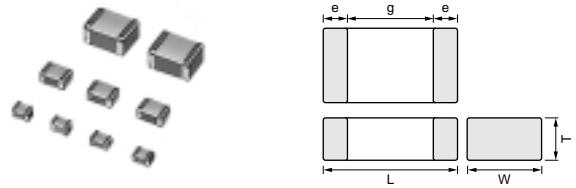

Part Number	Dimensions (mm)				
	L	W	T max.	e min.	g min.
ERB188	1.6±0.1	0.8±0.1	0.9	0.2	0.5
ERB21B	2.0±0.3	1.25±0.3	1.35	0.25	0.7
ERB32Q	3.2±0.3	2.5±0.3	1.7	0.3	1.0

www.tocosc.com

电容表

温度补偿型 C0G(5C) 特性

8 例 8: 厚度 [mm]

TC代号	C0G(5C)										
	1.6x0.8 (18) <0603>		2.0x1.25 (21) <0805>			3.2x2.5 (32) <1210>					
	长x宽 [mm]	额定电压 [Vdc]	250 (2E)	250 (2E)	100 (2A)	50 (1H)	500 (2H)	300 (YD)	250 (2E)	100 (2A)	50 (1H)
静电容量											
0.50pF(1R50)	8	B									
0.75pF(1R75)	8	B									
1.0pF(1R0)	8	B									
1.1pF(1R1)	8	B									
1.2pF(1R2)	8	B									
1.3pF(1R3)	8	B									
1.5pF(1R5)	8	B									
1.6pF(1R6)	8	B									
1.8pF(1R8)	8	B									
2.0pF(2R0)	8	B									
2.2pF(2R2)	8	B									
2.4pF(2R4)	8	B									
2.7pF(2R7)	8	B									
3.0pF(3R0)	8	B									
3.3pF(3R3)	8	B					Q				
3.6pF(3R6)	8	B					Q				
3.9pF(3R9)	8	B					Q				
4.0pF(4R0)	8	B					Q				
4.3pF(4R3)	8	B					Q				
4.7pF(4R7)	8	B					Q				
5.0pF(5R0)	8	B					Q				
5.1pF(5R1)	8	B					Q				
5.6pF(5R6)	8	B					Q				
6.0pF(6R0)	8	B					Q				
6.2pF(6R2)	8	B					Q				
6.8pF(6R8)	8	B					Q				
7.0pF(7R0)	8	B					Q				
7.5pF(7R5)	8	B					Q				
8.0pF(8R0)	8	B					Q				
8.2pF(8R2)	8	B					Q				
9.0pF(9R0)	8	B					Q				
9.1pF(9R1)	8	B					Q				
10pF(100)	8	B					Q				
11pF(110)	8	B					Q				
12pF(120)	8	B					Q				
13pF(130)	8	B					Q				
15pF(150)	8	B					Q				
16pF(160)	8	B					Q				
18pF(180)	8	B					Q				
20pF(200)	8	B					Q				
22pF(220)	8	B					Q				
24pF(240)	8	B					Q				
27pF(270)	8	B					Q				
30pF(300)	8	B					Q				
33pF(330)	8	B					Q				
36pF(360)	8	B					Q				
39pF(390)	8	B					Q				
43pF(430)	8	B					Q				

TC代号	C0G(5C)										
	1.6x0.8 (18) <0603>		2.0x1.25 (21) <0805>			3.2x2.5 (32) <1210>					
	长x宽 [mm]	额定电压 [Vdc]	250 (2E)	250 (2E)	100 (2A)	50 (1H)	500 (2H)	300 (YD)	250 (2E)	100 (2A)	50 (1H)
静电容量											
47pF(470)	8	B					Q				
51pF(510)	8	B					Q				
56pF(560)	8	B					Q				
62pF(620)	8	B					Q				
68pF(680)	8	B					Q				
75pF(750)	8	B					Q				
82pF(820)	8	B					Q				
91pF(910)	8	B					Q				
100pF(101)	8	B					Q				
110pF(111)					B		Q				
120pF(121)					B		Q				
130pF(131)					B			Q			
150pF(151)						B		Q			
160pF(161)						B			Q		
180pF(181)									Q		
200pF(201)									Q		
220pF(221)									Q		
240pF(241)										Q	
270pF(271)										Q	
300pF(301)										Q	
330pF(331)										Q	
360pF(361)										Q	
390pF(391)										Q	
430pF(431)										Q	
470pF(471)										Q	
510pF(511)											Q
560pF(561)											Q
620pF(621)											Q
680pF(681)											Q
750pF(751)											Q
820pF(821)											Q
910pF(911)											Q
1000pF(102)											Q

品名代号在()中注明，单位在 []中注明。 < >: EIA [英寸] 代号

温度补偿型 C0G(5C) 特性

长x宽 [mm]		1.6x0.8(18)<0603>	2.0x1.25(21)<0805>
额定电压 [Vdc]		250(2E)	250(2E)
静电容量	公差	品名	
0.50pF(R50)	±0.1pF(B)	ERB1885C2ER50BDX1D	ERB21B5C2ER50BDX1L
	±0.25pF(C)	ERB1885C2ER50CDX1D	ERB21B5C2ER50CDX1L
0.75pF(R75)	±0.1pF(B)	ERB1885C2ER75BDX1D	ERB21B5C2ER75BDX1L
	±0.25pF(C)	ERB1885C2ER75CDX1D	ERB21B5C2ER75CDX1L
1.0pF(1R0)	±0.1pF(B)	ERB1885C2E1R0BDX1D	ERB21B5C2E1R0BDX1L
	±0.25pF(C)	ERB1885C2E1R0CDX1D	ERB21B5C2E1R0CDX1L
1.1pF(1R1)	±0.1pF(B)	ERB1885C2E1R1BDX1D	ERB21B5C2E1R1BDX1L
	±0.25pF(C)	ERB1885C2E1R1CDX1D	ERB21B5C2E1R1CDX1L
1.2pF(1R2)	±0.1pF(B)	ERB1885C2E1R2BDX1D	ERB21B5C2E1R2BDX1L
	±0.25pF(C)	ERB1885C2E1R2CDX1D	ERB21B5C2E1R2CDX1L
1.3pF(1R3)	±0.1pF(B)	ERB1885C2E1R3BDX1D	ERB21B5C2E1R3BDX1L
	±0.25pF(C)	ERB1885C2E1R3CDX1D	ERB21B5C2E1R3CDX1L
1.5pF(1R5)	±0.1pF(B)	ERB1885C2E1R5BDX1D	ERB21B5C2E1R5BDX1L
	±0.25pF(C)	ERB1885C2E1R5CDX1D	ERB21B5C2E1R5CDX1L
1.6pF(1R6)	±0.1pF(B)	ERB1885C2E1R6BDX1D	ERB21B5C2E1R6BDX1L
	±0.25pF(C)	ERB1885C2E1R6CDX1D	ERB21B5C2E1R6CDX1L
1.8pF(1R8)	±0.1pF(B)	ERB1885C2E1R8BDX1D	ERB21B5C2E1R8BDX1L
	±0.25pF(C)	ERB1885C2E1R8CDX1D	ERB21B5C2E1R8CDX1L
2.0pF(2R0)	±0.1pF(B)	ERB1885C2E2R0BDX1D	ERB21B5C2E2R0BDX1L
	±0.25pF(C)	ERB1885C2E2R0CDX1D	ERB21B5C2E2R0CDX1L
2.2pF(2R2)	±0.1pF(B)	ERB1885C2E2R2BDX1D	ERB21B5C2E2R2BDX1L
	±0.25pF(C)	ERB1885C2E2R2CDX1D	ERB21B5C2E2R2CDX1L
2.4pF(2R4)	±0.1pF(B)	ERB1885C2E2R4BDX1D	ERB21B5C2E2R4BDX1L
	±0.25pF(C)	ERB1885C2E2R4CDX1D	ERB21B5C2E2R4CDX1L
2.7pF(2R7)	±0.1pF(B)	ERB1885C2E2R7BDX1D	ERB21B5C2E2R7BDX1L
	±0.25pF(C)	ERB1885C2E2R7CDX1D	ERB21B5C2E2R7CDX1L
3.0pF(3R0)	±0.1pF(B)	ERB1885C2E3R0BDX1D	ERB21B5C2E3R0BDX1L
	±0.25pF(C)	ERB1885C2E3R0CDX1D	ERB21B5C2E3R0CDX1L
3.3pF(3R3)	±0.1pF(B)	ERB1885C2E3R3BDX1D	ERB21B5C2E3R3BDX1L
	±0.25pF(C)	ERB1885C2E3R3CDX1D	ERB21B5C2E3R3CDX1L
3.6pF(3R6)	±0.1pF(B)	ERB1885C2E3R6BDX1D	ERB21B5C2E3R6BDX1L
	±0.25pF(C)	ERB1885C2E3R6CDX1D	ERB21B5C2E3R6CDX1L
3.9pF(3R9)	±0.1pF(B)	ERB1885C2E3R9BDX1D	ERB21B5C2E3R9BDX1L
	±0.25pF(C)	ERB1885C2E3R9CDX1D	ERB21B5C2E3R9CDX1L
4.0pF(4R0)	±0.1pF(B)	ERB1885C2E4R0BDX1D	ERB21B5C2E4R0BDX1L
	±0.25pF(C)	ERB1885C2E4R0CDX1D	ERB21B5C2E4R0CDX1L
4.3pF(4R3)	±0.1pF(B)	ERB1885C2E4R3BDX1D	ERB21B5C2E4R3BDX1L
	±0.25pF(C)	ERB1885C2E4R3CDX1D	ERB21B5C2E4R3CDX1L
4.7pF(4R7)	±0.1pF(B)	ERB1885C2E4R7BDX1D	ERB21B5C2E4R7BDX1L
	±0.25pF(C)	ERB1885C2E4R7CDX1D	ERB21B5C2E4R7CDX1L
5.0pF(5R0)	±0.1pF(B)	ERB1885C2E5R0BDX1D	ERB21B5C2E5R0BDX1L
	±0.25pF(C)	ERB1885C2E5R0CDX1D	ERB21B5C2E5R0CDX1L
5.1pF(5R1)	±0.1pF(B)	ERB1885C2E5R1BDX1D	ERB21B5C2E5R1BDX1L
	±0.25pF(C)	ERB1885C2E5R1CDX1D	ERB21B5C2E5R1CDX1L
	±0.5pF(D)	ERB1885C2E5R1DDX1D	ERB21B5C2E5R1DDX1L
5.6pF(5R6)	±0.1pF(B)	ERB1885C2E5R6BDX1D	ERB21B5C2E5R6BDX1L
	±0.25pF(C)	ERB1885C2E5R6CDX1D	ERB21B5C2E5R6CDX1L
	±0.5pF(D)	ERB1885C2E5R6DDX1D	ERB21B5C2E5R6DDX1L
6.0pF(6R0)	±0.1pF(B)	ERB1885C2E6R0BDX1D	ERB21B5C2E6R0BDX1L
	±0.25pF(C)	ERB1885C2E6R0CDX1D	ERB21B5C2E6R0CDX1L
	±0.5pF(D)	ERB1885C2E6R0DDX1D	ERB21B5C2E6R0DDX1L

品名代号在()中注明，单位在 []中注明。< >: EIA [英寸] 代号

(品名) ER B 18 8 5C 2E R50 B DX1 D
 ① ② ③ ④ ⑤ ⑥ ⑦ ⑧ ⑨ ⑩

- ① 型号
- ② 系列
- ③ 尺寸 (长 × 宽)
- ④ 尺寸 (厚度)
- ⑤ 温度特性
- ⑥ 额定电压
- ⑦ 静电容量
- ⑧ 静电容量公差
- ⑨ 个别规格代号
- ⑩ 包装

品名中的包装代号表示标准180mm卷盘。

温度补偿型 C0G(5C) 特性

长x宽 [mm]		1.6x0.8(18)<0603>	2.0x1.25(21)<0805>
额定电压 [Vdc]		250(2E)	250(2E)
静电容量	公差	品名	
6.2pF(6R2)	±0.1pF(B)	ERB1885C2E6R2BDX1D	ERB21B5C2E6R2BDX1L
	±0.25pF(C)	ERB1885C2E6R2CDX1D	ERB21B5C2E6R2CDX1L
	±0.5pF(D)	ERB1885C2E6R2DDX1D	ERB21B5C2E6R2DDX1L
6.8pF(6R8)	±0.1pF(B)	ERB1885C2E6R8BDX1D	ERB21B5C2E6R8BDX1L
	±0.25pF(C)	ERB1885C2E6R8CDX1D	ERB21B5C2E6R8CDX1L
	±0.5pF(D)	ERB1885C2E6R8DDX1D	ERB21B5C2E6R8DDX1L
7.0pF(7R0)	±0.1pF(B)	ERB1885C2E7R0BDX5D	ERB21B5C2E7R0BDX1L
	±0.25pF(C)	ERB1885C2E7R0CDX5D	ERB21B5C2E7R0CDX1L
	±0.5pF(D)	ERB1885C2E7R0DDX5D	ERB21B5C2E7R0DDX1L
7.5pF(7R5)	±0.1pF(B)	ERB1885C2E7R5BDX5D	ERB21B5C2E7R5BDX1L
	±0.25pF(C)	ERB1885C2E7R5CDX5D	ERB21B5C2E7R5CDX1L
	±0.5pF(D)	ERB1885C2E7R5DDX5D	ERB21B5C2E7R5DDX1L
8.0pF(8R0)	±0.1pF(B)	ERB1885C2E8R0BDX5D	ERB21B5C2E8R0BDX1L
	±0.25pF(C)	ERB1885C2E8R0CDX5D	ERB21B5C2E8R0CDX1L
	±0.5pF(D)	ERB1885C2E8R0DDX5D	ERB21B5C2E8R0DDX1L
8.2pF(8R2)	±0.1pF(B)	ERB1885C2E8R2BDX5D	ERB21B5C2E8R2BDX1L
	±0.25pF(C)	ERB1885C2E8R2CDX5D	ERB21B5C2E8R2CDX1L
	±0.5pF(D)	ERB1885C2E8R2DDX5D	ERB21B5C2E8R2DDX1L
9.0pF(9R0)	±0.1pF(B)	ERB1885C2E9R0BDX5D	ERB21B5C2E9R0BDX1L
	±0.25pF(C)	ERB1885C2E9R0CDX5D	ERB21B5C2E9R0CDX1L
	±0.5pF(D)	ERB1885C2E9R0DDX5D	ERB21B5C2E9R0DDX1L
9.1pF(9R1)	±0.1pF(B)	ERB1885C2E9R1BDX5D	ERB21B5C2E9R1BDX1L
	±0.25pF(C)	ERB1885C2E9R1CDX5D	ERB21B5C2E9R1CDX1L
	±0.5pF(D)	ERB1885C2E9R1DDX5D	ERB21B5C2E9R1DDX1L
10pF(100)	±2%(G)	ERB1885C2E100GDX5D	ERB21B5C2E100GDX1L
	±5%(J)	ERB1885C2E100JDX5D	ERB21B5C2E100JDX1L
11pF(110)	±2%(G)	ERB1885C2E110GDX5D	ERB21B5C2E110GDX1L
	±5%(J)	ERB1885C2E110JDX5D	ERB21B5C2E110JDX1L
12pF(120)	±2%(G)	ERB1885C2E120GDX5D	ERB21B5C2E120GDX1L
	±5%(J)	ERB1885C2E120JDX5D	ERB21B5C2E120JDX1L
13pF(130)	±2%(G)	ERB1885C2E130GDX5D	ERB21B5C2E130GDX1L
	±5%(J)	ERB1885C2E130JDX5D	ERB21B5C2E130JDX1L
15pF(150)	±2%(G)	ERB1885C2E150GDX5D	ERB21B5C2E150GDX1L
	±5%(J)	ERB1885C2E150JDX5D	ERB21B5C2E150JDX1L
16pF(160)	±2%(G)	ERB1885C2E160GDX5D	ERB21B5C2E160GDX1L
	±5%(J)	ERB1885C2E160JDX5D	ERB21B5C2E160JDX1L
18pF(180)	±2%(G)	ERB1885C2E180GDX5D	ERB21B5C2E180GDX1L
	±5%(J)	ERB1885C2E180JDX5D	ERB21B5C2E180JDX1L
20pF(200)	±2%(G)	ERB1885C2E200GDX5D	ERB21B5C2E200GDX1L
	±5%(J)	ERB1885C2E200JDX5D	ERB21B5C2E200JDX1L
22pF(220)	±2%(G)	ERB1885C2E220GDX5D	ERB21B5C2E220GDX1L
	±5%(J)	ERB1885C2E220JDX5D	ERB21B5C2E220JDX1L
24pF(240)	±2%(G)	ERB1885C2E240GDX5D	ERB21B5C2E240GDX1L
	±5%(J)	ERB1885C2E240JDX5D	ERB21B5C2E240JDX1L
27pF(270)	±2%(G)	ERB1885C2E270GDX5D	ERB21B5C2E270GDX1L
	±5%(J)	ERB1885C2E270JDX5D	ERB21B5C2E270JDX1L
30pF(300)	±2%(G)	ERB1885C2E300GDX5D	ERB21B5C2E300GDX1L
	±5%(J)	ERB1885C2E300JDX5D	ERB21B5C2E300JDX1L
33pF(330)	±2%(G)	ERB1885C2E330GDX5D	ERB21B5C2E330GDX1L
	±5%(J)	ERB1885C2E330JDX5D	ERB21B5C2E330JDX1L

品名代号在()中注明，单位在 []中注明。< >: EIA [英寸] 代号

(品名) ER B 18 8 5C 2E 6R2 B DX1 D
 ① ② ③ ④ ⑤ ⑥ ⑦ ⑧ ⑨ ⑩

- ① 型号
- ② 系列
- ③ 尺寸 (长 × 宽)
- ④ 尺寸 (厚度)
- ⑤ 温度特性
- ⑥ 额定电压
- ⑦ 静电容量
- ⑧ 静电容量公差
- ⑨ 个别规格代号
- ⑩ 包装

品名中的包装代号表示标准180mm卷盘。

温度补偿型 C0G(5C) 特性

长x宽 [mm]		1.6x0.8(18)<0603>		2.0x1.25(21)<0805>	
额定电压 [Vdc]		250(2E)		250(2E)	100(2A)
静电容量		公差		品名	
36pF(360)	±2%(G)	ERB1885C2E360GDX5D	ERB21B5C2E360GDX1L		
	±5%(J)	ERB1885C2E360JDX5D	ERB21B5C2E360JDX1L		
39pF(390)	±2%(G)	ERB1885C2E390GDX5D	ERB21B5C2E390GDX1L		
	±5%(J)	ERB1885C2E390JDX5D	ERB21B5C2E390JDX1L		
43pF(430)	±2%(G)	ERB1885C2E430GDX5D	ERB21B5C2E430GDX1L		
	±5%(J)	ERB1885C2E430JDX5D	ERB21B5C2E430JDX1L		
47pF(470)	±2%(G)	ERB1885C2E470GDX5D	ERB21B5C2E470GDX1L		
	±5%(J)	ERB1885C2E470JDX5D	ERB21B5C2E470JDX1L		
51pF(510)	±2%(G)	ERB1885C2E510GDX5D	ERB21B5C2E510GDX1L		
	±5%(J)	ERB1885C2E510JDX5D	ERB21B5C2E510JDX1L		
56pF(560)	±2%(G)	ERB1885C2E560GDX5D	ERB21B5C2E560GDX1L		
	±5%(J)	ERB1885C2E560JDX5D	ERB21B5C2E560JDX1L		
62pF(620)	±2%(G)	ERB1885C2E620GDX5D	ERB21B5C2E620GDX1L		
	±5%(J)	ERB1885C2E620JDX5D	ERB21B5C2E620JDX1L		
68pF(680)	±2%(G)	ERB1885C2E680GDX5D	ERB21B5C2E680GDX1L		
	±5%(J)	ERB1885C2E680JDX5D	ERB21B5C2E680JDX1L		
75pF(750)	±2%(G)	ERB1885C2E750GDX5D	ERB21B5C2E750GDX1L		
	±5%(J)	ERB1885C2E750JDX5D	ERB21B5C2E750JDX1L		
82pF(820)	±2%(G)	ERB1885C2E820GDX5D	ERB21B5C2E820GDX1L		
	±5%(J)	ERB1885C2E820JDX5D	ERB21B5C2E820JDX1L		
91pF(910)	±2%(G)	ERB1885C2E910GDX5D	ERB21B5C2E910GDX1L		
	±5%(J)	ERB1885C2E910JDX5D	ERB21B5C2E910JDX1L		
100pF(101)	±2%(G)	ERB1885C2E101GDX5D	ERB21B5C2E101GDX1L		
	±5%(J)	ERB1885C2E101JDX5D	ERB21B5C2E101JDX1L		
110pF(111)	±2%(G)		ERB21B5C2A111GDX1L		
	±5%(J)		ERB21B5C2A111JDX1L		
120pF(121)	±2%(G)		ERB21B5C2A121GDX1L		
	±5%(J)		ERB21B5C2A121JDX1L		
130pF(131)	±2%(G)		ERB21B5C2A131GDX1L		
	±5%(J)		ERB21B5C2A131JDX1L		
150pF(151)	±2%(G)			ERB21B5C1H151GDX1L	
	±5%(J)			ERB21B5C1H151JDX1L	
160pF(161)	±2%(G)			ERB21B5C1H161GDX1L	
	±5%(J)			ERB21B5C1H161JDX1L	

品名代号在()中注明，单位在 []中注明。< >: EIA [英寸] 代号

温度补偿型 C0G(5C) 特性

长x宽 [mm]		3.2x2.5(32)<1210>	
额定电压 [Vdc]		500(2H)	
静电容量	公差	品名	
3.3pF(3R3)	±0.1pF(B)	ERB32Q5C2H3R3BDX1L	
	±0.25pF(C)	ERB32Q5C2H3R3CDX1L	
3.6pF(3R6)	±0.1pF(B)	ERB32Q5C2H3R6BDX1L	
	±0.25pF(C)	ERB32Q5C2H3R6CDX1L	
3.9pF(3R9)	±0.1pF(B)	ERB32Q5C2H3R9BDX1L	
	±0.25pF(C)	ERB32Q5C2H3R9CDX1L	
4.0pF(4R0)	±0.1pF(B)	ERB32Q5C2H4R0BDX1L	
	±0.25pF(C)	ERB32Q5C2H4R0CDX1L	
4.3pF(4R3)	±0.1pF(B)	ERB32Q5C2H4R3BDX1L	
	±0.25pF(C)	ERB32Q5C2H4R3CDX1L	
4.7pF(4R7)	±0.1pF(B)	ERB32Q5C2H4R7BDX1L	
	±0.25pF(C)	ERB32Q5C2H4R7CDX1L	
5.0pF(5R0)	±0.1pF(B)	ERB32Q5C2H5R0BDX1L	
	±0.25pF(C)	ERB32Q5C2H5R0CDX1L	
5.1pF(5R1)	±0.1pF(B)	ERB32Q5C2H5R1BDX1L	
	±0.25pF(C)	ERB32Q5C2H5R1CDX1L	
	±0.5pF(D)	ERB32Q5C2H5R1DDX1L	
5.6pF(5R6)	±0.1pF(B)	ERB32Q5C2H5R6BDX1L	
	±0.25pF(C)	ERB32Q5C2H5R6CDX1L	
	±0.5pF(D)	ERB32Q5C2H5R6DDX1L	
6.0pF(6R0)	±0.1pF(B)	ERB32Q5C2H6R0BDX1L	
	±0.25pF(C)	ERB32Q5C2H6R0CDX1L	
	±0.5pF(D)	ERB32Q5C2H6R0DDX1L	
6.2pF(6R2)	±0.1pF(B)	ERB32Q5C2H6R2BDX1L	
	±0.25pF(C)	ERB32Q5C2H6R2CDX1L	
	±0.5pF(D)	ERB32Q5C2H6R2DDX1L	
6.8pF(6R8)	±0.1pF(B)	ERB32Q5C2H6R8BDX1L	
	±0.25pF(C)	ERB32Q5C2H6R8CDX1L	
	±0.5pF(D)	ERB32Q5C2H6R8DDX1L	
7.0pF(7R0)	±0.1pF(B)	ERB32Q5C2H7R0BDX1L	
	±0.25pF(C)	ERB32Q5C2H7R0CDX1L	
	±0.5pF(D)	ERB32Q5C2H7R0DDX1L	
7.5pF(7R5)	±0.1pF(B)	ERB32Q5C2H7R5BDX1L	
	±0.25pF(C)	ERB32Q5C2H7R5CDX1L	
	±0.5pF(D)	ERB32Q5C2H7R5DDX1L	
8.0pF(8R0)	±0.1pF(B)	ERB32Q5C2H8R0BDX1L	
	±0.25pF(C)	ERB32Q5C2H8R0CDX1L	
	±0.5pF(D)	ERB32Q5C2H8R0DDX1L	
8.2pF(8R2)	±0.1pF(B)	ERB32Q5C2H8R2BDX1L	
	±0.25pF(C)	ERB32Q5C2H8R2CDX1L	
	±0.5pF(D)	ERB32Q5C2H8R2DDX1L	
9.0pF(9R0)	±0.1pF(B)	ERB32Q5C2H9R0BDX1L	
	±0.25pF(C)	ERB32Q5C2H9R0CDX1L	
	±0.5pF(D)	ERB32Q5C2H9R0DDX1L	
9.1pF(9R1)	±0.1pF(B)	ERB32Q5C2H9R1BDX1L	
	±0.25pF(C)	ERB32Q5C2H9R1CDX1L	
	±0.5pF(D)	ERB32Q5C2H9R1DDX1L	
10pF(100)	±2%(G)	ERB32Q5C2H100GDX1L	
	±5%(J)	ERB32Q5C2H100JDX1L	

长x宽 [mm]		3.2x2.5(32)<1210>	
额定电压 [Vdc]		500(2H)	
静电容量	公差	品名	
11pF(110)	±2%(G)	ERB32Q5C2H110GDX1L	
	±5%(J)	ERB32Q5C2H110JDX1L	
12pF(120)	±2%(G)	ERB32Q5C2H120GDX1L	
	±5%(J)	ERB32Q5C2H120JDX1L	
13pF(130)	±2%(G)	ERB32Q5C2H130GDX1L	
	±5%(J)	ERB32Q5C2H130JDX1L	
15pF(150)	±2%(G)	ERB32Q5C2H150GDX1L	
	±5%(J)	ERB32Q5C2H150JDX1L	
16pF(160)	±2%(G)	ERB32Q5C2H160GDX1L	
	±5%(J)	ERB32Q5C2H160JDX1L	
18pF(180)	±2%(G)	ERB32Q5C2H180GDX1L	
	±5%(J)	ERB32Q5C2H180JDX1L	
20pF(200)	±2%(G)	ERB32Q5C2H200GDX1L	
	±5%(J)	ERB32Q5C2H200JDX1L	
22pF(220)	±2%(G)	ERB32Q5C2H220GDX1L	
	±5%(J)	ERB32Q5C2H220JDX1L	
24pF(240)	±2%(G)	ERB32Q5C2H240GDX1L	
	±5%(J)	ERB32Q5C2H240JDX1L	
27pF(270)	±2%(G)	ERB32Q5C2H270GDX1L	
	±5%(J)	ERB32Q5C2H270JDX1L	
30pF(300)	±2%(G)	ERB32Q5C2H300GDX1L	
	±5%(J)	ERB32Q5C2H300JDX1L	
33pF(330)	±2%(G)	ERB32Q5C2H330GDX1L	
	±5%(J)	ERB32Q5C2H330JDX1L	
36pF(360)	±2%(G)	ERB32Q5C2H360GDX1L	
	±5%(J)	ERB32Q5C2H360JDX1L	
39pF(390)	±2%(G)	ERB32Q5C2H390GDX1L	
	±5%(J)	ERB32Q5C2H390JDX1L	
43pF(430)	±2%(G)	ERB32Q5C2H430GDX1L	
	±5%(J)	ERB32Q5C2H430JDX1L	
47pF(470)	±2%(G)	ERB32Q5C2H470GDX1L	
	±5%(J)	ERB32Q5C2H470JDX1L	
51pF(510)	±2%(G)	ERB32Q5C2H510GDX1L	
	±5%(J)	ERB32Q5C2H510JDX1L	
56pF(560)	±2%(G)	ERB32Q5C2H560GDX1L	
	±5%(J)	ERB32Q5C2H560JDX1L	
62pF(620)	±2%(G)	ERB32Q5C2H620GDX1L	
	±5%(J)	ERB32Q5C2H620JDX1L	
68pF(680)	±2%(G)	ERB32Q5C2H680GDX1L	
	±5%(J)	ERB32Q5C2H680JDX1L	
75pF(750)	±2%(G)	ERB32Q5C2H750GDX1L	
	±5%(J)	ERB32Q5C2H750JDX1L	
82pF(820)	±2%(G)	ERB32Q5C2H820GDX1L	
	±5%(J)	ERB32Q5C2H820JDX1L	
91pF(910)	±2%(G)	ERB32Q5C2H910GDX1L	
	±5%(J)	ERB32Q5C2H910JDX1L	
100pF(101)	±2%(G)	ERB32Q5C2H101GDX1L	
	±5%(J)	ERB32Q5C2H101JDX1L	

品名代号在()中注明，单位在 []中注明。< >: EIA [英寸] 代号

(品名) ER B 32 Q 5C 2H 3R3 B DX1 L
 ① ② ③ ④ ⑤ ⑥ ⑦ ⑧ ⑨ ⑩

① 型号

② 系列

③ 尺寸 (长 × 宽)

④ 尺寸 (厚度)

⑤ 温度特性

⑥ 额定电压

⑦ 静电容量

⑧ 静电容量公差

⑨ 个别规格代号

⑩ 包装

品名中的包装代号表示标准180mm卷盘。

温度补偿型 C0G(5C) 特性

长x宽 [mm]		3.2x2.5(32)<1210>			
额定电压 [Vdc]		500(2H)	300(YD)	250(2E)	100(2A)
静电容量	公差	品名			
110pF(111)	±2%(G)	ERB32Q5C2H111GDX1L			
	±5%(J)	ERB32Q5C2H111JDX1L			
120pF(121)	±2%(G)	ERB32Q5C2H121GDX1L			
	±5%(J)	ERB32Q5C2H121JDX1L			
130pF(131)	±2%(G)		ERB32Q5CYD131GDX1L		
	±5%(J)		ERB32Q5CYD131JDX1L		
150pF(151)	±2%(G)		ERB32Q5CYD151GDX1L		
	±5%(J)		ERB32Q5CYD151JDX1L		
160pF(161)	±2%(G)			ERB32Q5C2E161GDX1L	
	±5%(J)			ERB32Q5C2E161JDX1L	
180pF(181)	±2%(G)			ERB32Q5C2E181GDX1L	
	±5%(J)			ERB32Q5C2E181JDX1L	
200pF(201)	±2%(G)			ERB32Q5C2E201GDX1L	
	±5%(J)			ERB32Q5C2E201JDX1L	
220pF(221)	±2%(G)			ERB32Q5C2E221GDX1L	
	±5%(J)			ERB32Q5C2E221JDX1L	
240pF(241)	±2%(G)				ERB32Q5C2A241GDX1L
	±5%(J)				ERB32Q5C2A241JDX1L
270pF(271)	±2%(G)				ERB32Q5C2A271GDX1L
	±5%(J)				ERB32Q5C2A271JDX1L
300pF(301)	±2%(G)				ERB32Q5C2A301GDX1L
	±5%(J)				ERB32Q5C2A301JDX1L
330pF(331)	±2%(G)				ERB32Q5C2A331GDX1L
	±5%(J)				ERB32Q5C2A331JDX1L
360pF(361)	±2%(G)				ERB32Q5C2A361GDX1L
	±5%(J)				ERB32Q5C2A361JDX1L
390pF(391)	±2%(G)				ERB32Q5C2A391GDX1L
	±5%(J)				ERB32Q5C2A391JDX1L
430pF(431)	±2%(G)				ERB32Q5C2A431GDX1L
	±5%(J)				ERB32Q5C2A431JDX1L
470pF(471)	±2%(G)				ERB32Q5C2A471GDX1L
	±5%(J)				ERB32Q5C2A471JDX1L

长x宽 [mm]		3.2x2.5(32)<1210>
额定电压 [Vdc]		50(1H)
静电容量	公差	品名
510pF(511)	±2%(G)	ERB32Q5C1H511GDX1L
	±5%(J)	ERB32Q5C1H511JDX1L
560pF(561)	±2%(G)	ERB32Q5C1H561GDX1L
	±5%(J)	ERB32Q5C1H561JDX1L
620pF(621)	±2%(G)	ERB32Q5C1H621GDX1L
	±5%(J)	ERB32Q5C1H621JDX1L
680pF(681)	±2%(G)	ERB32Q5C1H681GDX1L
	±5%(J)	ERB32Q5C1H681JDX1L
750pF(751)	±2%(G)	ERB32Q5C1H751GDX1L
	±5%(J)	ERB32Q5C1H751JDX1L
820pF(821)	±2%(G)	ERB32Q5C1H821GDX1L
	±5%(J)	ERB32Q5C1H821JDX1L
910pF(911)	±2%(G)	ERB32Q5C1H911GDX1L
	±5%(J)	ERB32Q5C1H911JDX1L
1000pF(102)	±2%(G)	ERB32Q5C1H102GDX1L
	±5%(J)	ERB32Q5C1H102JDX1L

品名代号在()中注明，单位在 []中注明。< >: EIA [英寸] 代号

6

ERB系列规格和测试方法

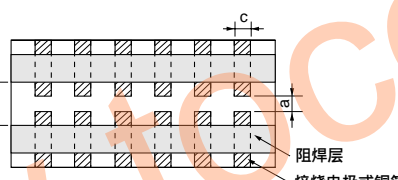
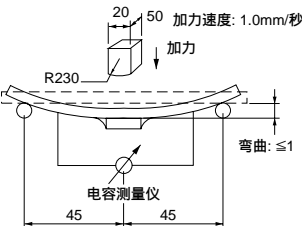
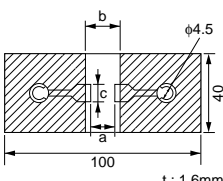
编号	项目	特性	测试方法														
1	动作温度范围	- 55至 + 125°C	参考温度: 25°C														
2	额定电压	参见上页	额定电压定义为可向电容器连续施加的最大电压。当交流电压附加于直流电压时，V ^{P-P} 或V ^{O-P} (以较大者为准) 应维持在额定电压范围内。														
3	外观	无缺陷或异常	目视检查														
4	尺寸	在规定尺寸范围内	使用游标卡尺														
5	介电强度	无缺陷或异常	在端子间施加300% (*) 额定电压1至5秒时不应观察到任何故障，并且充电/放电电流低于50mA。 (*) 300V: 250%, 500V: 200%														
6	绝缘电阻 (I.R.)	最小1,000,000M (C≤470pF) 最小100,000M (C>470pF)	绝缘电阻应在25°C及标准湿度条件下用不超过额定电压的直流电压测量，时间应选在充电开始后2分钟内。														
7	静电容量	在规定偏差范围内	静电容量/Q值应在25°C条件下，按表内的频率及电压测量。														
8	Q	C ≤ 220pF: Q ≥ 10,000 220pF < C ≤ 470pF: Q ≥ 5,000 470pF < C ≤ 1,000pF: Q ≥ 3,000 C: 标称静电容量 (pF)	<table border="1"> <tr> <td>频率</td> <td>1 ± 0.1MHz</td> </tr> <tr> <td>电压</td> <td>1 ± 0.2Vrms</td> </tr> </table>	频率	1 ± 0.1MHz	电压	1 ± 0.2Vrms										
频率	1 ± 0.1MHz																
电压	1 ± 0.2Vrms																
9	静电容量温度特性	静电容量变化	温度系数使用在第3阶段中测得的静电容量作为参考来确定。在依次通过第1至第5阶段的温度时，静电容量应在表A规定的温度系数和静电容量变化偏差范围内。 静电容量漂移是将在第1、3及5阶段测得的最大和最小值之间的差除以第3阶段的静电容量值计算而得。														
		温度系数															
		静电容量漂移		在 ± 0.2% 或 ± 0.05pF (以较大者为准) 范围内													
10	端子结合强度	不应出现端子脱落或其它缺陷。	使用共晶锡将电容器焊接在图1中所示的测试夹具 (玻璃环氧树脂板) 上。 然后平行于测试夹具施加10N*的力10 ± 1秒。 焊接应利用烙铁或使用回流焊接方法进行，而且应谨慎作业，以使焊接均匀且不会由于热冲击产生缺陷。														
		 <p>图1</p> <table border="1"> <thead> <tr> <th>型号</th> <th>a</th> <th>b</th> <th>c</th> </tr> </thead> <tbody> <tr> <td>ERB18</td> <td>1.0</td> <td>3.0</td> <td>1.2</td> </tr> <tr> <td>ERB21</td> <td>1.2</td> <td>4.0</td> <td>1.65</td> </tr> <tr> <td>ERB32</td> <td>2.2</td> <td>5.0</td> <td>2.9</td> </tr> </tbody> </table> <p>(in mm) *5N (ERB188)</p>		型号	a	b	c	ERB18	1.0	3.0	1.2	ERB21	1.2	4.0	1.65	ERB32	2.2
型号	a	b	c														
ERB18	1.0	3.0	1.2														
ERB21	1.2	4.0	1.65														
ERB32	2.2	5.0	2.9														
11	振荡电阻	外观	按照与 (10) 相同的方法和条件，将电容器焊接在测试夹具 (玻璃环氧树脂板) 上。电容器应进行简谐运动，其总幅值为1.5mm，频率在近似10至55Hz之间均匀变化。频率范围 (从10至55Hz再返回10Hz) 应在约1分钟内完成。 振动应在3个相互垂直方向各进行2小时 (总计6小时)。														
		静电容量															
		Q															
12	弯曲强度	外观	使用共晶锡将电容器焊接在图2a中所示的测试夹具 (玻璃环氧树脂板) 上。 然后在图3a所示的方向加力。 焊接应使用回流焊接方法进行，而且应谨慎作业，以使焊接均匀且不会由于热冲击产生缺陷。														
		静电容量变化		在 ± 5% 或 ± 0.5pF (以较大者为准) 范围内  <p>图3a</p>  <p>图2a</p> <table border="1"> <thead> <tr> <th>型号</th> <th>a</th> <th>b</th> <th>c</th> </tr> </thead> <tbody> <tr> <td>ERB18</td> <td>1.0</td> <td>3.0</td> <td>1.2</td> </tr> <tr> <td>ERB21</td> <td>1.2</td> <td>4.0</td> <td>1.65</td> </tr> <tr> <td>ERB32</td> <td>2.2</td> <td>5.0</td> <td>2.9</td> </tr> </tbody> </table> <p>(in mm)</p>	型号	a	b	c	ERB18	1.0	3.0	1.2	ERB21	1.2	4.0	1.65	ERB32
型号	a	b	c														
ERB18	1.0	3.0	1.2														
ERB21	1.2	4.0	1.65														
ERB32	2.2	5.0	2.9														
13	端子可焊性	95%端子需均匀且连续焊接。	将电容器浸在异丙醇和松香 (松香占25%的重量) 溶液中。在80至120°C范围内预热10至30秒。预热后，再浸泡在245 ± 5°C的共晶锡溶液或Sn-3.0Ag-0.5Cu无铅焊锡溶液5 ± 0.5秒。														

接下一页。 

ERB系列规格和测试方法

接上页。

编号	项目	特性	测试方法																											
14	耐焊热性	测量及观测到的特性应满足下表规定。 <table border="1"> <thead> <tr> <th>项目</th> <th>特性</th> </tr> </thead> <tbody> <tr> <td>外观</td> <td>无明显缺陷</td> </tr> <tr> <td>静电容量变化</td> <td>在±2.5%或±0.25pF(以较大者为准)范围内 C ≤ 220pF: Q ≥ 10,000</td> </tr> <tr> <td>Q</td> <td>220pF < C ≤ 470pF: Q ≥ 5,000 470pF < C ≤ 1,000pF: Q ≥ 3,000</td> </tr> <tr> <td>外观</td> <td>无失效</td> </tr> </tbody> </table> C: 标称静电容量 (pF)	项目	特性	外观	无明显缺陷	静电容量变化	在±2.5%或±0.25pF(以较大者为准)范围内 C ≤ 220pF: Q ≥ 10,000	Q	220pF < C ≤ 470pF: Q ≥ 5,000 470pF < C ≤ 1,000pF: Q ≥ 3,000	外观	无失效	根据下表中所列的条件进行预热。将电容器浸泡在270 ± 5°C的共晶锡溶液或Sn-3.0Ag-0.5Cu无铅焊锡溶液10 ± 0.5秒。在常温下放置24 ± 2小时。 <table border="1"> <thead> <tr> <th>尺寸</th> <th>预热条件</th> </tr> </thead> <tbody> <tr> <td>最大2.0 × 1.25mm</td> <td>120至150°C时1分钟</td> </tr> <tr> <td>3.2 × 2.5mm</td> <td>100至120°C时 然后是170至200°C时各1分钟</td> </tr> </tbody> </table>	尺寸	预热条件	最大2.0 × 1.25mm	120至150°C时1分钟	3.2 × 2.5mm	100至120°C时 然后是170至200°C时各1分钟											
项目	特性																													
外观	无明显缺陷																													
静电容量变化	在±2.5%或±0.25pF(以较大者为准)范围内 C ≤ 220pF: Q ≥ 10,000																													
Q	220pF < C ≤ 470pF: Q ≥ 5,000 470pF < C ≤ 1,000pF: Q ≥ 3,000																													
外观	无失效																													
尺寸	预热条件																													
最大2.0 × 1.25mm	120至150°C时1分钟																													
3.2 × 2.5mm	100至120°C时 然后是170至200°C时各1分钟																													
15	温度周期	测量及观测到的特性应满足下表规定。 <table border="1"> <thead> <tr> <th>项目</th> <th>特性</th> </tr> </thead> <tbody> <tr> <td>外观</td> <td>无明显缺陷</td> </tr> <tr> <td>静电容量变化</td> <td>在±5%或±0.5pF(以较大者为准)范围内 C ≥ 30pF: Q ≥ 350</td> </tr> <tr> <td>Q</td> <td>10pF ≤ C < 30pF: Q ≥ 275 + 5/2C C < 10pF: Q ≥ 200 + 10C</td> </tr> <tr> <td>绝缘电阻</td> <td>最小1,000MΩ</td> </tr> <tr> <td>外观</td> <td>无失效</td> </tr> </tbody> </table> C: 标称静电容量 (pF)	项目	特性	外观	无明显缺陷	静电容量变化	在±5%或±0.5pF(以较大者为准)范围内 C ≥ 30pF: Q ≥ 350	Q	10pF ≤ C < 30pF: Q ≥ 275 + 5/2C C < 10pF: Q ≥ 200 + 10C	绝缘电阻	最小1,000MΩ	外观	无失效	按照与(10)相同的方法和条件，将电容器固定在支撑夹具上。按照下表中列出的4种热处理方法执行5个周期。在常温下放置24 ± 2小时，然后进行测量。 <table border="1"> <thead> <tr> <th>阶段</th> <th>1</th> <th>2</th> <th>3</th> <th>4</th> </tr> </thead> <tbody> <tr> <td>最低动作温度</td> <td>+0/ -3</td> <td>常温</td> <td>最高动作温度 +3/ -0</td> <td>常温</td> </tr> <tr> <td>时间(分钟)</td> <td>30 ± 3</td> <td>最大5</td> <td>30 ± 3</td> <td>最大5</td> </tr> </tbody> </table>	阶段	1	2	3	4	最低动作温度	+0/ -3	常温	最高动作温度 +3/ -0	常温	时间(分钟)	30 ± 3	最大5	30 ± 3	最大5
项目	特性																													
外观	无明显缺陷																													
静电容量变化	在±5%或±0.5pF(以较大者为准)范围内 C ≥ 30pF: Q ≥ 350																													
Q	10pF ≤ C < 30pF: Q ≥ 275 + 5/2C C < 10pF: Q ≥ 200 + 10C																													
绝缘电阻	最小1,000MΩ																													
外观	无失效																													
阶段	1	2	3	4																										
最低动作温度	+0/ -3	常温	最高动作温度 +3/ -0	常温																										
时间(分钟)	30 ± 3	最大5	30 ± 3	最大5																										
16	湿度	测量及观测到的特性应满足下表规定。 <table border="1"> <thead> <tr> <th>项目</th> <th>特性</th> </tr> </thead> <tbody> <tr> <td>外观</td> <td>无明显缺陷</td> </tr> <tr> <td>静电容量变化</td> <td>在±5%或±0.5pF(以较大者为准)范围内 C ≥ 30pF: Q ≥ 350</td> </tr> <tr> <td>Q</td> <td>10pF ≤ C < 30pF: Q ≥ 275 + 5/2C C < 10pF: Q ≥ 200 + 10C</td> </tr> <tr> <td>绝缘电阻</td> <td>最小1,000MΩ</td> </tr> </tbody> </table> C: 标称静电容量 (pF)	项目	特性	外观	无明显缺陷	静电容量变化	在±5%或±0.5pF(以较大者为准)范围内 C ≥ 30pF: Q ≥ 350	Q	10pF ≤ C < 30pF: Q ≥ 275 + 5/2C C < 10pF: Q ≥ 200 + 10C	绝缘电阻	最小1,000MΩ	连续进行10次如下所示的24小时热(-10至+65°C)处理及湿度(80至100%)处理。再撤到常温下放置24 ± 2小时，然后进行测量。 																	
项目	特性																													
外观	无明显缺陷																													
静电容量变化	在±5%或±0.5pF(以较大者为准)范围内 C ≥ 30pF: Q ≥ 350																													
Q	10pF ≤ C < 30pF: Q ≥ 275 + 5/2C C < 10pF: Q ≥ 200 + 10C																													
绝缘电阻	最小1,000MΩ																													
17	高温负荷	测量及观测到的特性应满足下表规定。 <table border="1"> <thead> <tr> <th>项目</th> <th>特性</th> </tr> </thead> <tbody> <tr> <td>外观</td> <td>无明显缺陷</td> </tr> <tr> <td>静电容量变化</td> <td>在±3%或±0.3pF(以较大者为准)范围内 C ≥ 30pF: Q ≥ 350</td> </tr> <tr> <td>Q</td> <td>10pF ≤ C < 30pF: Q ≥ 275 + 5/2C C < 10pF: Q ≥ 200 + 10C</td> </tr> <tr> <td>绝缘电阻</td> <td>最小1,000MΩ</td> </tr> </tbody> </table> C: 标称静电容量 (pF)	项目	特性	外观	无明显缺陷	静电容量变化	在±3%或±0.3pF(以较大者为准)范围内 C ≥ 30pF: Q ≥ 350	Q	10pF ≤ C < 30pF: Q ≥ 275 + 5/2C C < 10pF: Q ≥ 200 + 10C	绝缘电阻	最小1,000MΩ	在125 ± 3°C条件下施加200% (500V时150%) 额定电压1,000 ± 12小时。撤到常温下放置24 ± 2小时，然后进行测量。充电/放电电流低于50mA。																	
项目	特性																													
外观	无明显缺陷																													
静电容量变化	在±3%或±0.3pF(以较大者为准)范围内 C ≥ 30pF: Q ≥ 350																													
Q	10pF ≤ C < 30pF: Q ≥ 275 + 5/2C C < 10pF: Q ≥ 200 + 10C																													
绝缘电阻	最小1,000MΩ																													

表A-6

特性代号	标称值 (ppm/°C) 注1	与25°C时静电容量值相比的变化 (%)					
		- 55		- 30		- 10	
		最大	最小	最大	最小	最大	最小
5C	0 ± 30	0.58	- 0.24	0.40	- 0.17	0.25	- 0.11

注1: 标称值表示在25至125°C范围内的温度系数。(特性5C时)

ERB系列数据

■ Q - 频率特性

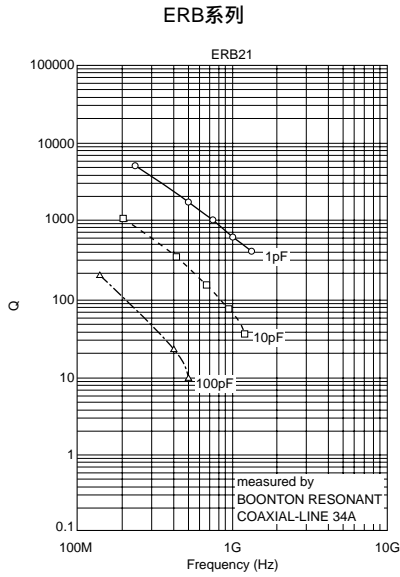

■ 阻抗 - 频率特性

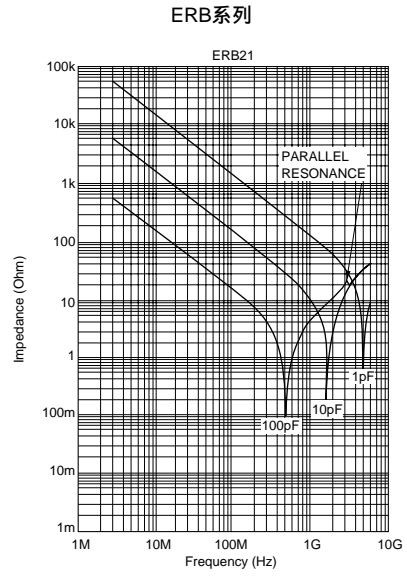

■ ESR - 频率特性

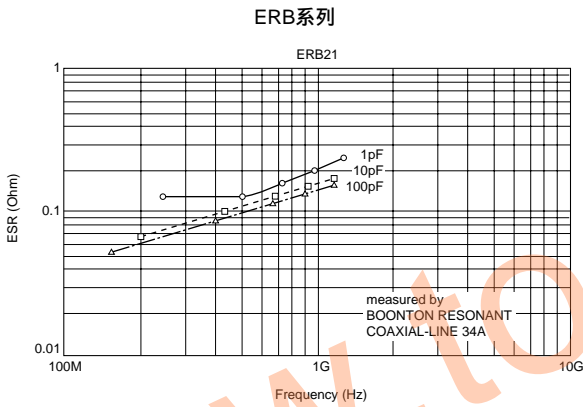

■ 自谐振频率 - 静电容量

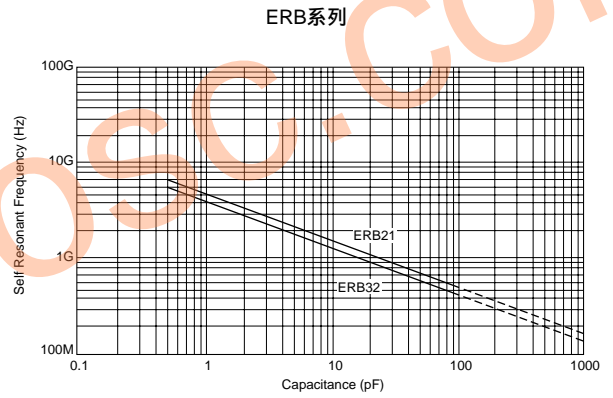

■ 允许电压 - 频率

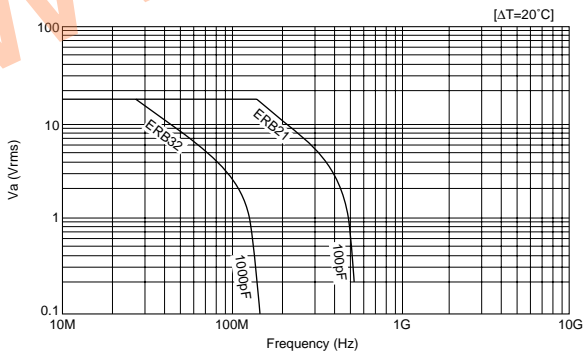

■ 允许电流 - 频率

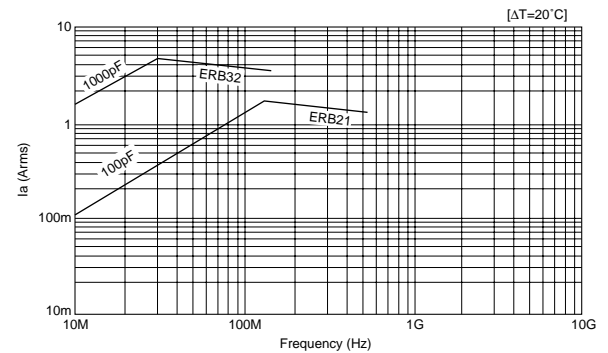

接下页。

ERB系列数据

接上页

允许视在功率 - 频率

允许有效功率 - 频率

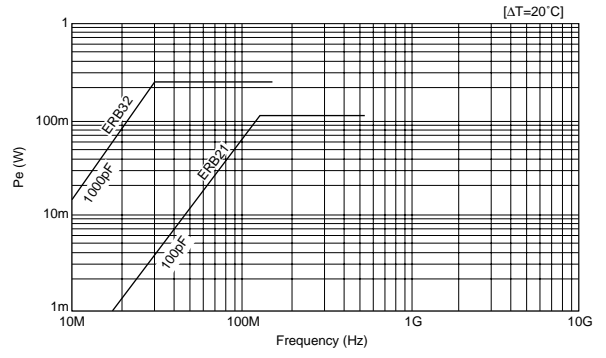
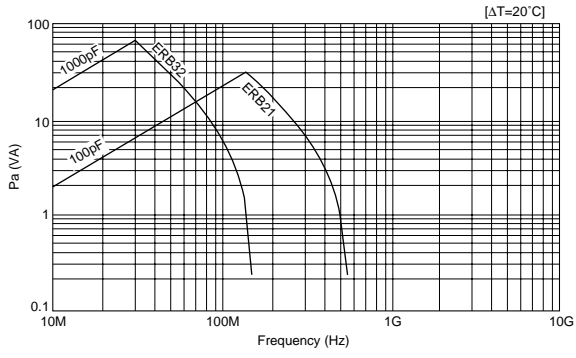

6

www.tocosc.com

片状独石陶瓷电容器



多层微片型GMA系列

特点

1. 更佳微波特性
2. 适合旁路
3. 高密度安装

用途

1. 光学通信机器用
2. IC、IC封装内藏用
3. 测量设备用

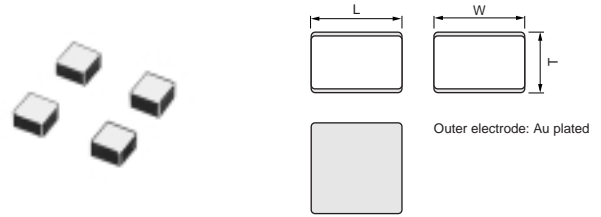

Part Number	Dimensions (mm)		
	L	W	T
GMA0D3	0.38 ±0.05	0.38 ±0.05	0.3 ±0.05
GMA05X	0.5 ±0.05	0.5 ±0.05	0.35 ±0.05
GMA085	0.8 ±0.05	0.8 ±0.05	0.5 ±0.1

7

电容表

高介电常数型 X7R(R7)/X5R(R6) 特性

X	例) X: 厚度 [mm]									
	长x宽 [mm]	0.38x0.38 (0D) <015015>				0.5x0.5 (05) <0202>			0.8x0.8 (08) <0303>	
额定电压 [Vdc]	10 (1A)	100 (2A)	25 (1E)	10 (1A)	6.3 (0J)	100 (2A)	25 (1E)	10 (1A)	6.3 (0J)	
TC代号	X7R (R7)	X7R (R7)			X5R (R6)	X7R (R7)			X5R (R6)	
静电容量		X								
100pF(101)		X								
150pF(151)		X								
220pF(221)		X								
330pF(331)		X								
470pF(471)		X								
680pF(681)		X								
1000pF(102)		X								
1500pF(152)			X			5				
2200pF(222)			X			5				
3300pF(332)			X			5				
4700pF(472)			X			5				
6800pF(682)				X		5				
10000pF(103)	3			X			5			
15000pF(153)				X			5			
22000pF(223)				X			5			
33000pF(333)								5		
47000pF(473)								5		
68000pF(683)								5		
0.10μF(104)					X			5		
0.47μF(474)										5

品名代号在()中注明，单位在 []中注明。< >: EIA [英寸] 代号

高介电常数型 X7R(R7)/X5R(R6) 特性

长x宽 [mm]	0.38x0.38(0D)<015015>	
额定电压 [Vdc]	10(1A)	
静电容量	公差	品名
10000pF(103)	±20%(M)	GMA0D3R71A103MA01T

长x宽 [mm]	0.5x0.5(05)<0202>			
额定电压 [Vdc]	100(2A)	25(1E)	10(1A)	6.3(0J)
静电容量	公差	品名		
100pF(101)	±20%(M)	GMA05XR72A101MA01T		
150pF(151)	±20%(M)	GMA05XR72A151MA01T		
220pF(221)	±20%(M)	GMA05XR72A221MA01T		
330pF(331)	±20%(M)	GMA05XR72A331MA01T		
470pF(471)	±20%(M)	GMA05XR72A471MA01T		
680pF(681)	±20%(M)	GMA05XR72A681MA01T		
1000pF(102)	±20%(M)	GMA05XR72A102MA01T		
1500pF(152)	±20%(M)		GMA05XR71E152MA11T	
2200pF(222)	±20%(M)		GMA05XR71E222MA11T	
3300pF(332)	±20%(M)		GMA05XR71E332MA11T	
4700pF(472)	±20%(M)		GMA05XR71E472MA11T	
6800pF(682)	±20%(M)			GMA05XR71A682MA01T
10000pF(103)	±20%(M)			GMA05XR71A103MA01T
15000pF(153)	±20%(M)			GMA05XR71A153MA01T
22000pF(223)	±20%(M)			GMA05XR71A223MA01T
33000pF(333)	±20%(M)			
47000pF(473)	±20%(M)			
68000pF(683)	±20%(M)			
0.10μF(104)	±20%(M)			GMA05XR60J104ME12T*

长x宽 [mm]	0.8x0.8(08)<0303>			
额定电压 [Vdc]	100(2A)	25(1E)	10(1A)	6.3(0J)
静电容量	公差	品名		
1500pF(152)	±20%(M)	GMA085R72A152MA01T		
2200pF(222)	±20%(M)	GMA085R72A222MA01T		
3300pF(332)	±20%(M)	GMA085R72A332MA01T		
4700pF(472)	±20%(M)	GMA085R72A472MA01T		
6800pF(682)	±20%(M)	GMA085R72A682MA01T		
10000pF(103)	±20%(M)		GMA085R71E103MA11T	
15000pF(153)	±20%(M)		GMA085R71E153MA11T	
22000pF(223)	±20%(M)		GMA085R71E223MA11T	
33000pF(333)	±20%(M)			GMA085R71A333MA01T
47000pF(473)	±20%(M)			GMA085R71A473MA01T
68000pF(683)	±20%(M)			GMA085R71A683MA01T
0.10μF(104)	±20%(M)			GMA085R71A104MA01T
0.47μF(474)	±20%(M)			GMA085R60J474ME12T*

品名代号在()中注明，单位在 []中注明。< >: EIA [英寸] 代号

*: 请参见GMA系列规格和测试方法 (2)。

(品名)

GM	A	0D	3	R7	1A	103	M	A01	T
①	②	③	④	⑤	⑥	⑦	⑧	⑨	⑩

① 型号
② 系列
③ 尺寸 (长×宽)
④ 尺寸 (厚度)
⑤ 温度特性
⑥ 额定电压
⑦ 静电容量
⑧ 静电容量公差
⑨ 个别规格代号
⑩ 包装

品名中的包装代号表示标准浅盘。

GMA系列规格和测试方法 (1)

当品名表中未附有“*”时，请参见GMA系列规格和测试方法(1)。
当品名表中附有“*”时，请参见GMA系列规格和测试方法(2)。

编号	项目	特性	测试方法															
1	动作温度范围	R7: - 55至 + 125°C	参考温度: 25°C															
2	额定电压	参见上页	额定电压定义为可向电容器连续施加的最大电压。 当交流电压附加于直流电压时， V^{P-P} 或 V^{O-P} (以较大者为准) 应维持在额定电压范围内。															
3	外观	无缺陷或异常	目视检查															
4	尺寸	在规定尺寸范围内	使用游标卡尺															
5	介电强度	无缺陷或异常	在两个端子之间施加250%额定电压1至5秒时不应观察到任何故障，并且充电/放电电流低于50mA。															
6	绝缘电阻	大于10,000MΩ或500Ω·F (以较小者为准)	绝缘电阻应在正常温度及湿度条件下用不超过额定电压的直流电压测量，时间应选在充电开始后2分钟内。															
7	静电容量	在规定偏差范围内	静电容量/D.F值应在参考温度条件下，按表内的频率及电压测量。															
8	散逸因数 (D.F)	R7: W.V.: 最小25V; 最大0.025 W.V.: 16/10V; 最大0.035	<table border="1"> <tr> <td>频率</td> <td>1 ± 0.1MHz</td> </tr> <tr> <td>电压</td> <td>1 ± 0.2Vrms</td> </tr> </table>	频率	1 ± 0.1MHz	电压	1 ± 0.2Vrms											
频率	1 ± 0.1MHz																	
电压	1 ± 0.2Vrms																	
9	静电容量温度特性	无偏置 R7: 在 ± 15% 范围内 (- 55至 + 125°C)	<p>静电容量变化应在进入规定的各温度阶段5分钟后测量。 表中所示的温度范围内静电容量的变化较于参考温度时容量的变化都应在规定范围内*</p> <table border="1"> <thead> <tr> <th>阶段</th> <th>温度 (°C)</th> </tr> </thead> <tbody> <tr> <td>1</td> <td>25 ± 2</td> </tr> <tr> <td>2</td> <td>- 55 ± 3</td> </tr> <tr> <td>3</td> <td>25 ± 2</td> </tr> <tr> <td>4</td> <td>125 ± 3</td> </tr> </tbody> </table> <p>*高介电常数型的初次测量 在150 + 0/ - 10°C条件下进行1小时热处理，然后在常温下放置24 ± 2小时。 之后进行初次测量。</p>	阶段	温度 (°C)	1	25 ± 2	2	- 55 ± 3	3	25 ± 2	4	125 ± 3					
阶段	温度 (°C)																	
1	25 ± 2																	
2	- 55 ± 3																	
3	25 ± 2																	
4	125 ± 3																	
10	机械强度	<p>粘结强度 拉力: 最小0.03N</p> <p>介电剪切强度 介电剪切力: 最小2N</p>	<p>MIL-STD-883方法2011条件D 将电容器装于镀金氧化铝基片 (Au-Sn80/20)，并采用超声键合法将25μm (0.001英寸) 金线粘结在电容器端子上。然后拉动金线。</p> <p>MIL-STD-883方法2019 将电容器装于镀金氧化铝基片 (Au-Sn80/20)。然后平行于基片加力。</p>															
11	振荡电阻	<p>外观 无缺陷或异常</p> <p>静电容量 在规定偏差范围内</p> <p>D.F. R7: W.V.: 最小25V; 最大0.025 W.V.: 16/10V; 最大0.035</p>	使频率从10Hz变到55Hz，然后再返回10Hz，全部在1分钟内完成。幅值: 整个振幅最大1.5mm (0.06英寸)。在3个相互垂直方向各进行2小时上述运动 (总计6小时)。															
12	温度周期	<p>外观 无明显缺陷</p> <p>静电容量变化 R7: 在 ± 7.5% 范围内</p> <p>D.F. R7: W.V.: 最小25V; 最大0.025 W.V.: 16/10V; 最大0.035</p> <p>绝缘电阻 大于10,000MΩ或500Ω·F (以较小者为准)</p> <p>介电强度 无缺陷</p>	<p>在150 + 0/ - 10°C条件下经过1小时热处理，电容器应在常温条件下放置24 ± 2小时，然后进行初次测量。按照与(11)相同的方法和条件，将电容器固定在支撑夹具上，根据下表所示的温度及时间执行5个周期。在常温下放置24 ± 2小时，然后进行测量。</p> <table border="1"> <thead> <tr> <th>阶段</th> <th>1</th> <th>2</th> <th>3</th> <th>4</th> </tr> </thead> <tbody> <tr> <td>温度 (°C)</td> <td>最低动作温度 + 0/ - 3</td> <td>常温</td> <td>最高动作温度 + 3/ - 0</td> <td>常温</td> </tr> <tr> <td>时间 (分钟)</td> <td>30 ± 3</td> <td>2至3</td> <td>30 ± 3</td> <td>2至3</td> </tr> </tbody> </table>	阶段	1	2	3	4	温度 (°C)	最低动作温度 + 0/ - 3	常温	最高动作温度 + 3/ - 0	常温	时间 (分钟)	30 ± 3	2至3	30 ± 3	2至3
阶段	1	2	3	4														
温度 (°C)	最低动作温度 + 0/ - 3	常温	最高动作温度 + 3/ - 0	常温														
时间 (分钟)	30 ± 3	2至3	30 ± 3	2至3														
13	湿度 (稳态)	<p>外观 无缺陷或异常</p> <p>静电容量变化 R7: 在 ± 12.5% 范围内</p> <p>D.F. R7: W.V.: 最小10V; 最大0.05</p> <p>绝缘电阻 大于1,000MΩ或50Ω·F (以较小者为准)</p>	将电容器在40 ± 20°C，90至95%湿度条件下放置500 ± 12小时。将其撤到常温下放置24 ± 2小时，然后进行测量。															
14	湿度负荷	<p>外观 无缺陷或异常</p> <p>静电容量变化 R7: 在 ± 12.5% 范围内</p> <p>D.F. R7: W.V.: 最小10V; 最大0.05</p> <p>绝缘电阻 大于500MΩ或25Ω·F (以较小者为准)</p>	在40 ± 2°C，90至95%湿度条件下施加额定电压500 ± 12小时，再在常温下放置24 ± 2小时，然后进行测量。充电/放电电流低于50mA。															

测试时的安装: 在进行11至15项测试时，电容器应如下所示使用芯片结合和引线结合方法装于基片。

接下页。 

GMA系列规格和测试方法 (1)

☐ 接上页。

当品名表中未附有“*”时，请参见GMA系列规格和测试方法(1)。
 当品名表中附有“*”时，请参见GMA系列规格和测试方法(2)。

编号	项目	特性	测试方法
15	高温负荷		电容器应经过电压处理; 处理时, 应先在最高动作温度 $\pm 3^{\circ}\text{C}$ 条件下施加200%直流额定电压1小时, 然后在常温下放置 24 ± 2 小时, 最后再进行初次测量。 之后, 在相同温度条件下连续施加上述电压 1000 ± 12 小时, 再将其从槽中取出在常温下放置 24 ± 2 小时, 然后进行测量。充电/放电电流低于50mA。
	外观	无缺陷或异常	
	静电容量变化	R7: 在 $\pm 12.5\%$ 范围内	
	D.F.	R7: W.V.: 最小10V; 最大0.05	
	绝缘电阻	大于1,000M Ω 或50 $\Omega \cdot \text{F}$ (以较小者为准)	

测试时的安装: 在进行11至15项测试时, 电容器应如下所示使用芯片结合和引线结合方法装于基片。

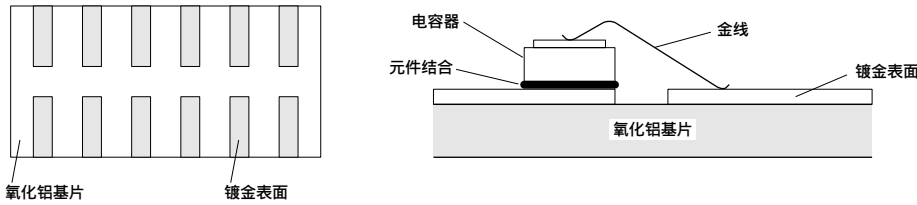

www.tocosc.com

GMA系列规格和测试方法 (2)

当品名表中未附有“*”时，请参见GMA系列规格和测试方法(1)。
 当品名表中附有“*”时，请参见GMA系列规格和测试方法(2)。

编号	项目	特性	测试方法															
1	动作温度范围	R6: -55至85°C	参考温度: 25°C															
2	额定电压	参见上页	额定电压定义为可向电容器连续施加的最大电压。 当交流电压附加于直流电压时，V ^{P-P} 或V ^{O-P} (以较大者为准) 应维持在额定电压范围内。															
3	外观	无缺陷或异常	目视检查															
4	尺寸	在规定尺寸范围内	使用游标卡尺															
5	介电强度	无缺陷或异常	在两个端子之间施加250%额定电压1至5秒时不应观察到任何故障，并且充电/放电电流低于50mA。															
6	绝缘电阻	大于50Ω·F	绝缘电阻应在正常温度及湿度条件下用不超过额定电压的直流电压测量，时间应选在充电开始后1分钟内。															
7	静电容量	在规定偏差范围内	静电容量/D.F值应在参考温度条件下，按表内的频率及电压测量。															
8	散逸因数 (D.F)	R6: 最大0.1	<table border="1"> <thead> <tr> <th>静电容量</th> <th>频率</th> <th>电压</th> </tr> </thead> <tbody> <tr> <td>C≤10μF (6.3Vmax.)</td> <td>1±0.1kHz</td> <td>0.5±0.1Vrms</td> </tr> </tbody> </table>	静电容量	频率	电压	C≤10μF (6.3Vmax.)	1±0.1kHz	0.5±0.1Vrms									
静电容量	频率	电压																
C≤10μF (6.3Vmax.)	1±0.1kHz	0.5±0.1Vrms																
9	静电容量温度特性	无偏置 R6: 在±15%范围内 (-55至+85°C)	静电容量变化应在进入规定的各温度阶段5分钟后测量。 表中所示的温度范围内静电容量的变化较于参考温度时容量的变化都应在规定范围内。* <table border="1"> <thead> <tr> <th>阶段</th> <th>温度 (°C)</th> </tr> </thead> <tbody> <tr> <td>1</td> <td>25±2</td> </tr> <tr> <td>2</td> <td>-55±3</td> </tr> <tr> <td>3</td> <td>25±2</td> </tr> <tr> <td>4</td> <td>85±3</td> </tr> </tbody> </table> *高介电常数型的初次测量 在150+0/-10°C条件下进行1小时热处理，然后在常温下放置24±2小时。之后进行初次测量。	阶段	温度 (°C)	1	25±2	2	-55±3	3	25±2	4	85±3					
阶段	温度 (°C)																	
1	25±2																	
2	-55±3																	
3	25±2																	
4	85±3																	
10	机械强度	粘结强度 拉力: 最小0.03N 介电剪切强度 介电剪切力: 最小2N	MIL-STD-883方法2011条件D 将电容器装于镀金氧化铝基片 (Au-Sn80/20)，并采用超声球焊法将25μm (0.001英寸) 金线粘结在电容器端子上。然后拉动金线。 MIL-STD-883方法2019 将电容器装于镀金氧化铝基片 (Au-Sn80/20)。然后平行于基片加力。															
11	振荡电阻	外观 无缺陷或异常 静电容量 在规定偏差范围内 D.F. R6: 最大0.1	使频率从10Hz变到55Hz，然后再返回10Hz，全部在1分钟内完成。幅值: 整个振幅最大1.5mm (0.06英寸)。在3个相互垂直方向各进行2小时上述运动 (总计6小时)。															
12	温度突变	外观 无缺陷或异常 静电容量变化 R6: 在±7.5%范围内 D.F. R6: 最大0.1 绝缘电阻 大于50Ω·F 介电强度 无缺陷	在150+0/-10°C条件下经过1小时热处理，电容器应在常温条件下放置24±2小时，然后进行初次测量。按照与(11)相同的方法和条件，将电容器固定在支撑夹具上，根据下表所示的温度及时间执行5个周期。在常温下放置48±4小时，然后进行测量。 <table border="1"> <thead> <tr> <th>阶段</th> <th>1</th> <th>2</th> <th>3</th> <th>4</th> </tr> </thead> <tbody> <tr> <td>温度 (°C)</td> <td>最低动作温度 +0/-3</td> <td>常温</td> <td>最高动作温度 +3/-0</td> <td>常温</td> </tr> <tr> <td>时间 (分钟)</td> <td>30±3</td> <td>2至3</td> <td>30±3</td> <td>2至3</td> </tr> </tbody> </table>	阶段	1	2	3	4	温度 (°C)	最低动作温度 +0/-3	常温	最高动作温度 +3/-0	常温	时间 (分钟)	30±3	2至3	30±3	2至3
阶段	1	2	3	4														
温度 (°C)	最低动作温度 +0/-3	常温	最高动作温度 +3/-0	常温														
时间 (分钟)	30±3	2至3	30±3	2至3														
13	高温高湿 (稳态)	外观 无缺陷或异常 静电容量变化 R6: 在±12.5%范围内 D.F. R6: 最大0.2 绝缘电阻 大于12.5Ω·F	在40±2°C及90至95%相对湿度条件下施加额定电压500±12小时后，在常温下放置24±2小时，然后再进行测量。充电/放电电流低于50mA。 •初次测量 在150+0/-10°C条件下进行1小时热处理，然后在常温下放置24±2小时。之后进行初次测量。 •测试后测量 在150+0/-10°C条件下进行1小时热处理后，在常温下放置24±2小时，然后再进行测量。															

测试时的安装: 在进行11至14项测试时，电容器应如下所示使用芯片结合和引线结合方法装于基片。

接下页。 

GMA系列规格和测试方法 (2)

接上页。

当品名表中未附有“*”时，请参见GMA系列规格和测试方法(1)。
 当品名表中附有“*”时，请参见GMA系列规格和测试方法(2)。

编号	项目	特性	测试方法
14	外观	无缺陷或异常	在最高工作温度 $\pm 3^{\circ}\text{C}$ 条件下施加150%额定电压1000 \pm 12小时，再在常温下放置24 \pm 2小时，然后进行测量。 充电 / 放电电流低于50mA。 • 初次测量 在150 \pm 0 / - 10 $^{\circ}\text{C}$ 条件下进行1小时热处理，然后在常温下放置24 \pm 2小时。之后进行初次测量。 • 测试后测量 在150 \pm 0 / - 10 $^{\circ}\text{C}$ 条件下进行1小时热处理后，在常温下放置24 \pm 2小时，然后再进行测量。
	静电容量变化	R6: 在 $\pm 12.5\%$ 范围内	
	D.F.	R6: 最大0.2	
	绝缘电阻	大于12.5 $\Omega \cdot \text{F}$	

测试时的安装: 在进行11至14项测试时，电容器应如下所示使用芯片结合和引线结合方法装于基片。

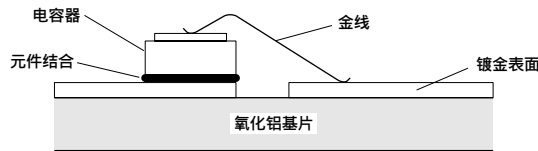
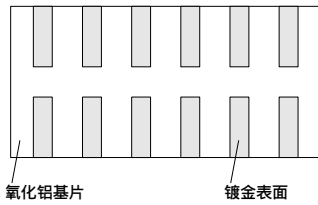

www.tocosc.com

片状独石陶瓷电容器



结合 (Bonding) 用GMD系列

特点

1. 小型元件尺寸
(长 × 宽 × 厚度: 0.6 × 0.3 × 0.3mm, 1.0 × 0.5 × 0.5mm)。
2. 由于使用金电极，可进行引线 / 元件结合。
3. 适用于光学通信机器和IC封装内藏用。

用途

1. 光学通信机器用
2. IC、IC封装内藏用

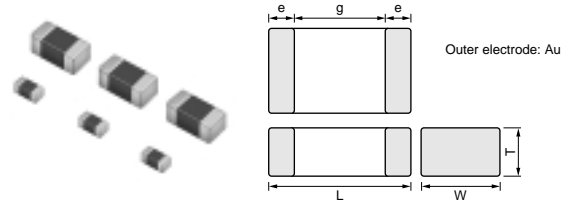

Part Number	Dimensions (mm)				
	L	W	T	e	g min.
GMD033	0.6±0.03	0.3±0.03	0.3±0.03	0.12 to 0.22	0.16
GMD155	1.0±0.05	0.5±0.05	0.5±0.05	0.15 to 0.35	0.3

www.tocosc.com

电容表

高介电常数型 X7R(R7)/X5R(R6) 特性

3		例 3: 厚度 [mm]							
长x宽 [mm]	0.6x0.3 (03) <0201>			1.0x0.5 (15) <0402>			0.6x0.3 (03) <0201>	1.0x0.5 (15) <0402>	
额定电压 [Vdc]	25 (1E)	16 (1C)	10 (1A)	50 (1H)	25 (1E)	16 (1C)	6.3 (0J)	10 (1A)	6.3 (0J)
静电容量	TC代号 X7R (R7)						X5R (R6)		
100pF(101)	3								
120pF(121)	3								
150pF(151)	3								
180pF(181)	3								
220pF(221)	3			5					
270pF(271)	3			5					
330pF(331)	3			5					
390pF(391)	3			5					
470pF(471)	3			5					
560pF(561)	3			5					
680pF(681)	3			5					
820pF(821)	3			5					
1000pF(102)	3			5					
1200pF(122)	3			5					
1500pF(152)	3			5					
1800pF(182)		3		5					
2200pF(222)		3		5					
2700pF(272)		3		5					
3300pF(332)		3		5					
3900pF(392)			3	5					
4700pF(472)			3	5					
5600pF(562)			3		5				
6800pF(682)			3		5				
8200pF(822)			3		5				
10000pF(103)			3		5				
12000pF(123)					5				
15000pF(153)					5				
18000pF(183)					5				
22000pF(223)					5				
27000pF(273)					5				
33000pF(333)					5				
39000pF(393)					5				
47000pF(473)					5				
56000pF(563)						5	3		
68000pF(683)						5	3		
82000pF(823)						5	3		
0.10μF(104)						5	3		
0.12μF(124)								5	
0.15μF(154)								5	
0.18μF(184)								5	
0.22μF(224)								5	
0.27μF(274)								5	
0.33μF(334)								5	
0.39μF(394)								5	
0.47μF(474)								5	
1.0μF(105)									5

品名代号在()中注明，单位在 []中注明。< >: EIA [英寸] 代号

高介电常数型 X7R(R7) 特性

长x宽 [mm]		0.6x0.3(03)<0201>		
额定电压 [Vdc]		25(1E)	16(1C)	10(1A)
静电容量	公差	品名		
100pF(101)	±10%(K)	GMD033R71E101KA01D		
120pF(121)	±10%(K)	GMD033R71E121KA01D		
150pF(151)	±10%(K)	GMD033R71E151KA01D		
180pF(181)	±10%(K)	GMD033R71E181KA01D		
220pF(221)	±10%(K)	GMD033R71E221KA01D		
270pF(271)	±10%(K)	GMD033R71E271KA01D		
330pF(331)	±10%(K)	GMD033R71E331KA01D		
390pF(391)	±10%(K)	GMD033R71E391KA01D		
470pF(471)	±10%(K)	GMD033R71E471KA01D		
560pF(561)	±10%(K)	GMD033R71E561KA01D		
680pF(681)	±10%(K)	GMD033R71E681KA01D		
820pF(821)	±10%(K)	GMD033R71E821KA01D		
1000pF(102)	±10%(K)	GMD033R71E102KA01D		
1200pF(122)	±10%(K)	GMD033R71E122KA01D		
1500pF(152)	±10%(K)	GMD033R71E152KA01D		
1800pF(182)	±10%(K)		GMD033R71C182KA11D	
2200pF(222)	±10%(K)		GMD033R71C222KA11D	
2700pF(272)	±10%(K)		GMD033R71C272KA11D	
3300pF(332)	±10%(K)		GMD033R71C332KA11D	
3900pF(392)	±10%(K)			GMD033R71A392KA01D
4700pF(472)	±10%(K)			GMD033R71A472KA01D
5600pF(562)	±10%(K)			GMD033R71A562KA01D
6800pF(682)	±10%(K)			GMD033R71A682KA01D
8200pF(822)	±10%(K)			GMD033R71A822KA01D
10000pF(103)	±10%(K)			GMD033R71A103KA01D

品名代号在()中注明，单位在 []中注明。 < >: EIA [英寸] 代号

- | | | | | | | | | | | | | | | | |
|------|-----------|----------|-----------|----------|-----------|-----------|------------|----------|------------|----------|-------|-------|----------|---------|-------|
| (品名) | GM | D | 03 | 3 | R7 | 1E | 101 | K | A01 | D | ①型号 | ②系列 | ③尺寸(长×宽) | ④尺寸(厚度) | ⑤温度特性 |
| | ① | ② | ③ | ④ | ⑤ | ⑥ | ⑦ | ⑧ | ⑨ | ⑩ | ⑥额定电压 | ⑦静电容量 | ⑧静电容量公差 | ⑨个别规格代号 | ⑩包装 |

品名中的包装代号表示标准180mm卷盘。

高介电常数型 X7R(R7) 特性

长x宽 [mm]		1.0x0.5(15)<0402>		
额定电压 [Vdc]		50(1H)	25(1E)	16(1C)
静电容量	公差	品名		
220pF(221)	±10%(K)	GMD155R71H221KA01D		
270pF(271)	±10%(K)	GMD155R71H271KA01D		
330pF(331)	±10%(K)	GMD155R71H331KA01D		
390pF(391)	±10%(K)	GMD155R71H391KA01D		
470pF(471)	±10%(K)	GMD155R71H471KA01D		
560pF(561)	±10%(K)	GMD155R71H561KA01D		
680pF(681)	±10%(K)	GMD155R71H681KA01D		
820pF(821)	±10%(K)	GMD155R71H821KA01D		
1000pF(102)	±10%(K)	GMD155R71H102KA01D		
1200pF(122)	±10%(K)	GMD155R71H122KA01D		
1500pF(152)	±10%(K)	GMD155R71H152KA01D		
1800pF(182)	±10%(K)	GMD155R71H182KA01D		
2200pF(222)	±10%(K)	GMD155R71H222KA01D		
2700pF(272)	±10%(K)	GMD155R71H272KA01D		
3300pF(332)	±10%(K)	GMD155R71H332KA01D		
3900pF(392)	±10%(K)	GMD155R71H392KA01D		
4700pF(472)	±10%(K)	GMD155R71H472KA01D		
5600pF(562)	±10%(K)		GMD155R71E562KA01D	
6800pF(682)	±10%(K)		GMD155R71E682KA01D	
8200pF(822)	±10%(K)		GMD155R71E822KA01D	
10000pF(103)	±10%(K)		GMD155R71E103KA01D	
12000pF(123)	±10%(K)		GMD155R71E123KA01D	
15000pF(153)	±10%(K)		GMD155R71E153KA01D	
18000pF(183)	±10%(K)		GMD155R71E183KA01D	
22000pF(223)	±10%(K)		GMD155R71E223KA01D	
27000pF(273)	±10%(K)		GMD155R71E273KA11D	
33000pF(333)	±10%(K)		GMD155R71E333KA11D	
39000pF(393)	±10%(K)		GMD155R71E393KA11D	
47000pF(473)	±10%(K)		GMD155R71E473KA11D	
56000pF(563)	±10%(K)			GMD155R71C563KA11D
68000pF(683)	±10%(K)			GMD155R71C683KA11D
82000pF(823)	±10%(K)			GMD155R71C823KA11D
0.10μF(104)	±10%(K)			GMD155R71C104KA11D

品名代号在()中注明，单位在 []中注明。< >: EIA [英寸] 代号

高介电常数型 X5R(R6) 特性

长x宽 [mm]		0.6x0.3(03)<0201>	1.0x0.5(15)<0402>	
额定电压 [Vdc]		6.3(0J)	10(1A)	6.3(0J)
静电容量	公差	品名		
56000pF(563)	±10%(K)	GMD033R60J563KE11D*		
68000pF(683)	±10%(K)	GMD033R60J683KE11D*		
82000pF(823)	±10%(K)	GMD033R60J823KE11D*		
0.10μF(104)	±10%(K)	GMD033R60J104KE11D*		
0.12μF(124)	±10%(K)		GMD155R61A124KE12D*	
0.15μF(154)	±10%(K)		GMD155R61A154KE12D*	
0.18μF(184)	±10%(K)		GMD155R61A184KE12D*	
0.22μF(224)	±10%(K)		GMD155R61A224KE12D*	
0.27μF(274)	±10%(K)		GMD155R61A274KE11D*	
0.33μF(334)	±10%(K)		GMD155R61A334KE11D*	
0.39μF(394)	±10%(K)		GMD155R61A394KE11D*	
0.47μF(474)	±10%(K)		GMD155R61A474KE11D*	
1.0μF(105)	±10%(K)			GMD155R60J105KE11D*

品名代号在()中注明，单位在 []中注明。<>: EIA [英寸] 代号

*: 请参见GMD系列规格和测试方法 (2)。

(品名) **GM** **D** **03** **3** **R6** **0J** **563** **K** **E11** **D** ①型号 ②系列 ③尺寸(长×宽) ④尺寸(厚度) ⑤温度特性
 ⑥额定电压 ⑦静电容量 ⑧静电容量公差 ⑨个别规格代号 ⑩包装

品名中的包装代号表示标准180mm卷盘。

GMD系列规格和测试方法 (1)

当品名表中未附有“*”时，请参见GMD系列规格和测试方法(1)。
 当品名表中附有“*”时，请参见GMD系列规格和测试方法(2)。

编号	项目	特性	测试方法																				
1	动作温度范围	R7: - 55至 + 125°C	参考温度: 25°C																				
2	额定电压	参见上页	额定电压定义为可向电容器连续施加的最大电压。 当交流电压附加于直流电压时，V ^{P-P} 或V ^{O-P} (以较大者为准) 应维持在额定电压范围内。																				
3	外观	无缺陷或异常	目视检查																				
4	尺寸	在规定尺寸范围内	使用游标卡尺																				
5	介电强度	无缺陷或异常	在两个端子之间施加250%额定电压1至5秒时不应观察到任何故障，并且充电/放电电流低于50mA。																				
6	绝缘电阻	大于10,000MΩ或500Ω·F (以较小者为准)	绝缘电阻应在正常温度及湿度条件下用不超过额定电压的直流电压测量，时间应选在充电开始后2分钟内。																				
7	静电容量	在规定偏差范围内	静电容量/D.F值应在参考温度条件下，按表内的频率及电压测量。																				
8	散逸因数 (D.F)	R7: W.V. 最小25V: 最大0.025 W.V. 16/10V: 最大0.035	<table border="1" style="width: 100%;"> <tr> <td>频率</td> <td>1 ± 0.1kHz</td> </tr> <tr> <td>电压</td> <td>1 ± 0.2Vrms</td> </tr> </table>	频率	1 ± 0.1kHz	电压	1 ± 0.2Vrms																
频率	1 ± 0.1kHz																						
电压	1 ± 0.2Vrms																						
9	静电容量温度特性	无偏置 R7: 在 ± 15% (- 55至 + 125°C) 范围内	静电容量变化应在进入规定的各温度阶段5分钟后测量。 表中所示的温度范围内静电容量的变化较于参考温度时容量的变化都应在规定范围内。* <table border="1" style="width: 100%; margin-top: 10px;"> <thead> <tr> <th>阶段</th> <th>温度 (°C)</th> </tr> </thead> <tbody> <tr> <td>1</td> <td>25 ± 2</td> </tr> <tr> <td>2</td> <td>- 55 ± 3</td> </tr> <tr> <td>3</td> <td>25 ± 2</td> </tr> <tr> <td>4</td> <td>125 ± 3</td> </tr> </tbody> </table> *高介电常数型的初次测量 在150 + 0/- 10°C条件下进行1小时热处理，然后在常温下放置24 ± 2小时。 之后进行初次测量。	阶段	温度 (°C)	1	25 ± 2	2	- 55 ± 3	3	25 ± 2	4	125 ± 3										
阶段	温度 (°C)																						
1	25 ± 2																						
2	- 55 ± 3																						
3	25 ± 2																						
4	125 ± 3																						
10	机械强度	粘结强度 拉力: 最小0.03N 介电剪切强度 介电剪切力: 最小2N	MIL-STD-883方法2011条件D 将电容器装于镀金氧化铝基片 (Au-Sn80/20)，并采用超声球焊法将25μm (0.001英寸) 金线粘结在电容器端子上。然后拉动金线。 MIL-STD-883方法2019 将电容器装于镀金氧化铝基片 (Au-Sn80/20)。然后平行于基片加力。																				
11	振荡电阻	外观 无缺陷或异常 静电容量 在规定偏差范围内 D.F. R7: W.V. 最小25V: 最大0.025 W.V. 16/10V: 最大0.035	使频率从10Hz变到55Hz，然后再返回10Hz，全部在1分钟内完成。幅值: 整个振幅最大1.5mm (0.06英寸)。在3个相互垂直方向各进行2小时上述运动 (总计6小时)。																				
12	温度周期	外观 无缺陷或异常 静电容量变化 R7: 在 ± 7.5% 范围内 D.F. R7: W.V. 最小25V: 最大0.025 W.V. 16/10V: 最大0.035 绝缘电阻 大于10,000MΩ或500Ω·F (以较小者为准) 介电强度 无缺陷	在150 + 0/- 10°C条件下经过1小时热处理，电容器应在常温条件下放置24 ± 2小时，然后进行初次测量。按照与(11)相同的方法和条件，将电容器固定在支撑夹具上，根据下表所示的温度及时间执行5个周期。在常温下放置24 ± 2小时，然后进行测量。 <table border="1" style="width: 100%; margin-top: 10px;"> <thead> <tr> <th>阶段</th> <th>1</th> <th>2</th> <th>3</th> <th>4</th> </tr> </thead> <tbody> <tr> <td>最低动作温度 + 0/- 3</td> <td>常温</td> <td>最高动作温度 + 3/- 0</td> <td>常温</td> <td></td> </tr> <tr> <td>温度 (°C)</td> <td></td> <td></td> <td></td> <td></td> </tr> <tr> <td>时间 (分钟)</td> <td>30 ± 3</td> <td>2至3</td> <td>30 ± 3</td> <td>2至3</td> </tr> </tbody> </table>	阶段	1	2	3	4	最低动作温度 + 0/- 3	常温	最高动作温度 + 3/- 0	常温		温度 (°C)					时间 (分钟)	30 ± 3	2至3	30 ± 3	2至3
阶段	1	2	3	4																			
最低动作温度 + 0/- 3	常温	最高动作温度 + 3/- 0	常温																				
温度 (°C)																							
时间 (分钟)	30 ± 3	2至3	30 ± 3	2至3																			
13	湿度 (稳态)	外观 无缺陷或异常 静电容量变化 R7: 在 ± 12.5% 范围内 D.F. R7: W.V. 最小25V: 最大0.05 W.V. 16/10V: 最大0.05 绝缘电阻 大于1,000MΩ或50Ω·F (以较小者为准)	将电容器在40 ± 20°C，90至95%湿度条件下放置500 ± 12小时。将其撤到常温下放置24 ± 2小时，然后进行测量。																				

测试时的安装: 在进行11至15项测试时，电容器应如下所示使用芯片结合和引线结合方法装于基片。

接下页。

GMD系列规格和测试方法 (1)

☐ 接上页。

当品名表中未附有“*”时，请参见GMD系列规格和测试方法(1)。
 当品名表中附有“*”时，请参见GMD系列规格和测试方法(2)。

编号	项目	特性	测试方法	
14	湿度负荷	外观	在40±2°C，90至95%湿度条件下施加额定电压500±12小时，再在常温下放置24±2小时，然后进行测量。充电/放电电流低于50mA。	
		静电容量变化		R7: 在±12.5%范围内
		D.F.		R7: W.V. 最小25V: 最大0.05 W.V. 16/10V: 最大0.05
		绝缘电阻		大于500MΩ或25Ω·F (以较小者为准)
15	高温负荷	外观	电容器应经过电压处理: 处理时，应在最高动作温度±3°C条件下施加200%直流额定电压1小时，然后在常温下放置24±2小时，最后再进行初次测量。 之后，在相同温度条件下连续施加上述电压1000±12小时，再将其从槽中取出在常温下放置24±2小时，然后进行测量。充电/放电电流低于50mA。	
		静电容量变化		R7: 在±12.5%范围内
		D.F.		R7: W.V. 最小25V: 最大0.05 W.V. 16/10V: 最大0.05
		绝缘电阻		大于1,000MΩ或50Ω·F (以较小者为准)

测试时的安装: 在进行11至15项测试时，电容器应如下所示使用芯片结合和引线结合方法装于基片。

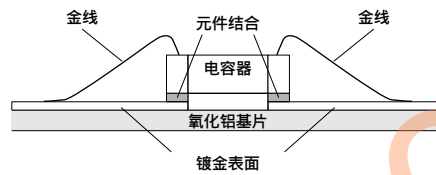
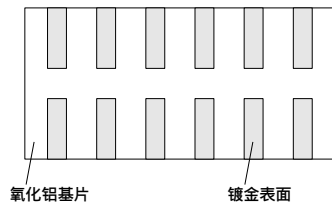

GMD系列规格和测试方法 (2)

当品名表中未附有“*”时, 请参见GMD系列规格和测试方法(1)。
 当品名表中附有“*”时, 请参见GMD系列规格和测试方法(2)。

编号	项目	特性	测试方法															
1	动作温度范围	R6: - 55 至85°C	参考温度: 25°C															
2	额定电压	参见上页	额定电压定义为可向电容器连续施加的最大电压。 当交流电压附加于直流电压时, V^{P-P} 或 V^{O-P} (以较大者为准) 应维持在额定电压范围内。															
3	外观	无缺陷或异常	目视检查															
4	尺寸	在规定尺寸范围内	使用游标卡尺															
5	介电强度	无缺陷或异常	在两个端子之间施加250%额定电压1至5秒时不应观察到任何故障, 并且充电/放电电流低于50mA。															
6	绝缘电阻	大于 $50\Omega \cdot F$	绝缘电阻应在正常温度及湿度条件下用不超过额定电压的直流电压测量, 时间应选在充电开始后1分钟内。															
7	静电容量	在规定偏差范围内	静电容量/D.F值应在参考温度条件下, 按表内的频率及电压测量。															
8	散逸因数 (D.F)	R6: 最大0.1	<table border="1" style="width: 100%; border-collapse: collapse; margin-bottom: 5px;"> <thead> <tr> <th>静电容量</th> <th>频率</th> <th>电压</th> </tr> </thead> <tbody> <tr> <td>$C \leq 10\mu F$ (10Vmin.)*1</td> <td>$1 \pm 0.1kHz$</td> <td>$1.0 \pm 0.2V_{rms}$</td> </tr> <tr> <td>$C \leq 10\mu F$ (6.3Vmax.)</td> <td>$1 \pm 0.1kHz$</td> <td>$0.5 \pm 0.1V_{rms}$</td> </tr> </tbody> </table> *1 对于GMD155 R6 1A 124至224应施加 $0.5 \pm 0.1V_{rms}$ 。	静电容量	频率	电压	$C \leq 10\mu F$ (10Vmin.)*1	$1 \pm 0.1kHz$	$1.0 \pm 0.2V_{rms}$	$C \leq 10\mu F$ (6.3Vmax.)	$1 \pm 0.1kHz$	$0.5 \pm 0.1V_{rms}$						
静电容量	频率	电压																
$C \leq 10\mu F$ (10Vmin.)*1	$1 \pm 0.1kHz$	$1.0 \pm 0.2V_{rms}$																
$C \leq 10\mu F$ (6.3Vmax.)	$1 \pm 0.1kHz$	$0.5 \pm 0.1V_{rms}$																
9	静电容量温度特性	无偏置 R6: 在 $\pm 15\%$ 范围内 (- 55至 + 85°C)	静电容量变化应在进入规定的各温度阶段5分钟后测量。 表中所示的温度范围内静电容量的变化较于参考温度时容量的变化都应在规定范围内。* <table border="1" style="width: 100%; border-collapse: collapse; margin-top: 10px;"> <thead> <tr> <th>阶段</th> <th>温度 (°C)</th> </tr> </thead> <tbody> <tr> <td>1</td> <td>25 ± 2</td> </tr> <tr> <td>2</td> <td>$- 55 \pm 3$</td> </tr> <tr> <td>3</td> <td>25 ± 2</td> </tr> <tr> <td>4</td> <td>85 ± 3</td> </tr> </tbody> </table> *高介电常数型的初次测量 在 $150 \pm 0 / - 10^\circ C$ 条件下进行1小时热处理, 然后在常温下放置 24 ± 2 小时。 之后进行初次测量。	阶段	温度 (°C)	1	25 ± 2	2	$- 55 \pm 3$	3	25 ± 2	4	85 ± 3					
阶段	温度 (°C)																	
1	25 ± 2																	
2	$- 55 \pm 3$																	
3	25 ± 2																	
4	85 ± 3																	
10	机械强度	粘结强度 拉力: 最小0.03N 介电剪切强度 介电剪切力: 最小2N	MIL-STD-883方法2011条件D 将电容器装于镀金氧化铝基片 (Au-Sn80/20), 并采用超声球焊法将 $25\mu m$ (0.001英寸) 金线粘结在电容器端子上。然后拉动金线。 MIL-STD-883方法2019 将电容器装于镀金氧化铝基片 (Au-Sn80/20)。然后平行于基片加力。															
11	振荡电阻	外观 无缺陷或异常 静电容量 在规定偏差范围内 D.F. R6: 最大0.1	使频率从10Hz变到55Hz, 然后再返回10Hz, 全部在1分钟内完成。幅值: 整个振幅最大1.5mm (0.06英寸)。在3个相互垂直方向各进行2小时上述运动 (总计6小时)。															
12	温度周期	外观 无缺陷或异常 静电容量变化 R6: 在 $\pm 7.5\%$ 范围内 D.F. R6: 最大0.1 绝缘电阻 大于 $50\Omega \cdot F$ 介电强度 无缺陷	在 $150 \pm 0 / - 10^\circ C$ 条件下经过1小时热处理, 电容器应在常温条件下放置 24 ± 2 小时, 然后进行初次测量。按照与(11)相同的方法和条件, 将电容器固定在支撑夹具上, 根据下表所示的温度及时间执行5个周期。在常温下放置 24 ± 2 小时, 然后进行测量。 <table border="1" style="width: 100%; border-collapse: collapse; margin-top: 10px;"> <thead> <tr> <th>阶段</th> <th>1</th> <th>2</th> <th>3</th> <th>4</th> </tr> </thead> <tbody> <tr> <td>温度 (°C)</td> <td>最低动作温度 $+ 0 / - 3$</td> <td>常温</td> <td>最高动作温度 $+ 3 / - 0$</td> <td>常温</td> </tr> <tr> <td>时间 (分钟)</td> <td>30 ± 3</td> <td>2至3</td> <td>30 ± 3</td> <td>2至3</td> </tr> </tbody> </table>	阶段	1	2	3	4	温度 (°C)	最低动作温度 $+ 0 / - 3$	常温	最高动作温度 $+ 3 / - 0$	常温	时间 (分钟)	30 ± 3	2至3	30 ± 3	2至3
阶段	1	2	3	4														
温度 (°C)	最低动作温度 $+ 0 / - 3$	常温	最高动作温度 $+ 3 / - 0$	常温														
时间 (分钟)	30 ± 3	2至3	30 ± 3	2至3														
13	高温高湿 (稳态)	外观 无缺陷或异常 静电容量变化 R6: 在 $\pm 12.5\%$ 范围内 D.F. R6: 最大0.2 绝缘电阻 大于 $12.5\Omega \cdot F$	在 $40 \pm 2^\circ C$ 及90至95%相对湿度条件下施加额定电压 500 ± 12 小时后, 在常温下放置 24 ± 2 小时, 然后再进行测量。充电 / 放电电流低于50mA。 • 初次测量 在 $150 \pm 0 / - 10^\circ C$ 条件下进行1小时热处理, 然后在常温下放置 24 ± 2 小时。之后进行初次测量。 • 测试后测量 在 $150 \pm 0 / - 10^\circ C$ 条件下进行1小时热处理后, 在常温下放置 24 ± 2 小时, 然后再进行测量。															

测试时的安装: 在进行11至14项测试时, 电容器应如下所示使用芯片结合和引线结合方法装于基片。

接下页。

GMD系列规格和测试方法 (2)

☐ 接上页。

当品名表中未附有“*”时，请参见GMD系列规格和测试方法(1)。
 当品名表中附有“*”时，请参见GMD系列规格和测试方法(2)。

编号	项目	特性	测试方法
14	外观	无缺陷或异常	在最高工作温度 $\pm 3^{\circ}\text{C}$ 条件下施加 $150\%^{*2}$ 额定电压 1000 ± 12 小时，再在常温下放置 24 ± 2 小时，然后进行测量。 充电 / 放电电流低于 50mA 。 *2 对于 GMD155 R6 1A 274 至 474 应施加 120% 。 • 初次测量 在 $150 + 0 / - 10^{\circ}\text{C}$ 条件下进行 1 小时热处理，然后在常温下放置 24 ± 2 小时。之后进行初次测量。 • 测试后测量 在 $150 + 0 / - 10^{\circ}\text{C}$ 条件下进行 1 小时热处理后，在常温下放置 24 ± 2 小时，然后再进行测量。
	静电容量变化	R6: 在 $\pm 12.5\%$ 范围内	
	D.F.	R6: 最大 0.2	
	绝缘电阻	大于 $25\Omega \cdot \text{F}$	

测试时的安装: 在进行 11 至 14 项测试时，电容器应如下所示使用芯片结合和引线结合方法装于基片。

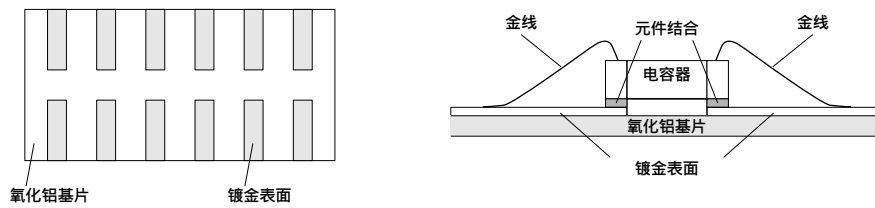

www.tocosc.com

■ 最少订购数量指南

品名	尺寸 (mm)			数量 (件)				散装盒	散装袋	
	L	W	T	ø180mm卷盘		ø330mm卷盘				
包装代号				纸带	压纹带	纸带	压纹带	C	散装: B 浅盘: T	
一般用	GRM02	0.4	0.2	0.2	20,000 ¹⁾	40,000 ¹⁾	-	-	-	1,000
	GRM03	0.6	0.3	0.3	15,000	-	50,000	-	-	1,000
	GRM15	1.0	0.5	0.25/0.3	10,000	-	50,000	-	-	1,000
				0.5	10,000	-	50,000	-	50,000	1,000
	GRM18	1.6	0.8	0.5	4,000	-	10,000	-	-	1,000
				0.8	4,000	-	10,000	-	15,000 ²⁾	1,000
	GRM21	2.0	1.25	0.6	4,000	-	10,000	-	10,000	1,000
				0.85	4,000	-	10,000	-	-	1,000
				1.0/1.25	-	3,000	-	10,000	5,000 ²⁾	1,000
	GRM31	3.2	1.6	0.6/0.85	4,000	-	10,000	-	-	1,000
				1.15	-	3,000	-	10,000	-	1,000
				1.6	-	2,000	-	6,000	-	1,000
	GRM32	3.2	2.5	0.85	4,000	-	10,000	-	-	1,000
				1.15	-	3,000	-	10,000	-	1,000
				1.35	-	2,000	-	8,000	-	1,000
				1.6	-	2,000	-	6,000	-	1,000
	GRM43	4.5	3.2	1.8/2.0	-	1,000	-	4,000	-	1,000
				2.5	-	500	-	2,000	-	1,000
				2.8	-	500	-	1,500	-	500
				1.15	-	1,000	-	5,000	-	1,000
GRM55	5.7	5.0	1.35/1.6	-	1,000	-	4,000	-	1,000	
			1.8/2.0	-	500	-	2,000	-	500	
			2.5	-	500	-	2,000	-	500	
			3.2	-	300	-	1,500	-	500	
大功率型	GJM03	0.6	0.3	0.3	15,000	-	50,000	-	-	1,000
	GJM15	1.0	0.5	0.5	10,000	-	50,000	-	50,000	1,000
高频型	GQM18	1.6	0.8	0.7/0.8	4,000	-	10,000	-	-	1,000
	GQM21	2.0	1.25	0.85	4,000	-	10,000	-	-	1,000
	ERB18	1.6	0.8	最大0.9	4,000	-	10,000	-	-	1,000
	ERB21	2.0	1.25	最大1.35	-	3,000	-	10,000	-	1,000
	ERB32	3.2	2.5	最大1.7	-	2,000	-	8,000	-	1,000
多层微片型	GMA0D	0.38	0.38	0.3	-	-	-	-	-	400 ³⁾
	GMA05	0.5	0.5	0.35	-	-	-	-	-	400 ³⁾
	GMA08	0.8	0.8	0.5	-	-	-	-	-	400 ³⁾
	GMD03	0.6	0.3	0.3	15,000	-	50,000	-	-	1,000
	GMD15	1.0	0.5	0.5	10,000	-	50,000	-	-	1,000
排容	GNM0M	0.9	0.6	0.45	10,000	-	50,000	-	-	1,000
	GNM1M	1.37	1.0	0.5/0.6/0.8	4,000	-	10,000	-	-	1,000
	GNM21	2.0	1.25	0.5/0.6/0.85	4,000	-	10,000	-	-	1,000
	GNM31	3.2	1.6	0.8/0.85	4,000	-	10,000	-	-	1,000
低ESL型	LLL15	0.5	1.0	0.3	10,000 ⁴⁾	-	50,000 ⁴⁾	-	-	1,000
				0.5	-	4,000	-	10,000	-	1,000
	LLL18	0.8	1.6	0.5/0.6	-	4,000	-	10,000	-	1,000
				0.85	-	3,000	-	10,000	-	1,000
	LLL21	1.25	2.0	0.5/0.7	-	4,000	-	10,000	-	1,000
				1.15	-	3,000	-	10,000	-	1,000
	LLL31	1.6	3.2	0.5	-	4,000	-	10,000	-	1,000
				1.15	-	3,000	-	10,000	-	1,000
	LLA18	1.6	0.8	0.5	-	4,000	-	10,000	-	1,000
				0.5	-	4,000	-	10,000	-	1,000
	LLA21	2.0	1.25	0.5	-	4,000	-	10,000	-	1,000
				0.85	-	3,000	-	10,000	-	1,000
LLA31	3.2	1.6	0.5	-	4,000	-	10,000	-	1,000	
			0.85	-	3,000	-	10,000	-	1,000	
LLM21	2.0	1.25	0.5	-	4,000	-	10,000	-	1,000	
			1.15	-	3,000	-	10,000	-	1,000	
LLM31	3.2	1.6	0.5	-	4,000	-	10,000	-	1,000	

1) 8mm宽2mm间距纸带。4mm宽1mm间距压纹带。
 2) 有一部分品名中没有散装盒包装。
 3) 浅盘
 4) LLL15: ø180mm卷盘纸带包装代号: E, ø330mm卷盘纸带包装代号: F

包装

接上页。

编带包装

(1) 卷盘尺寸

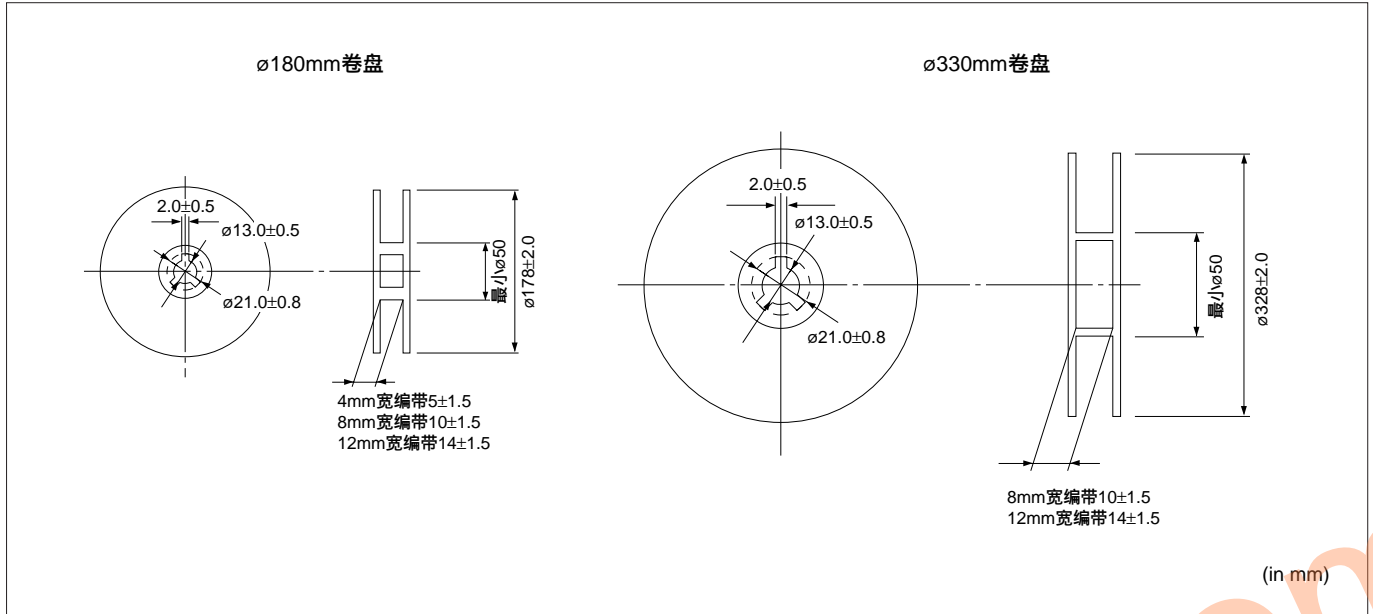

(2) 纸带尺寸

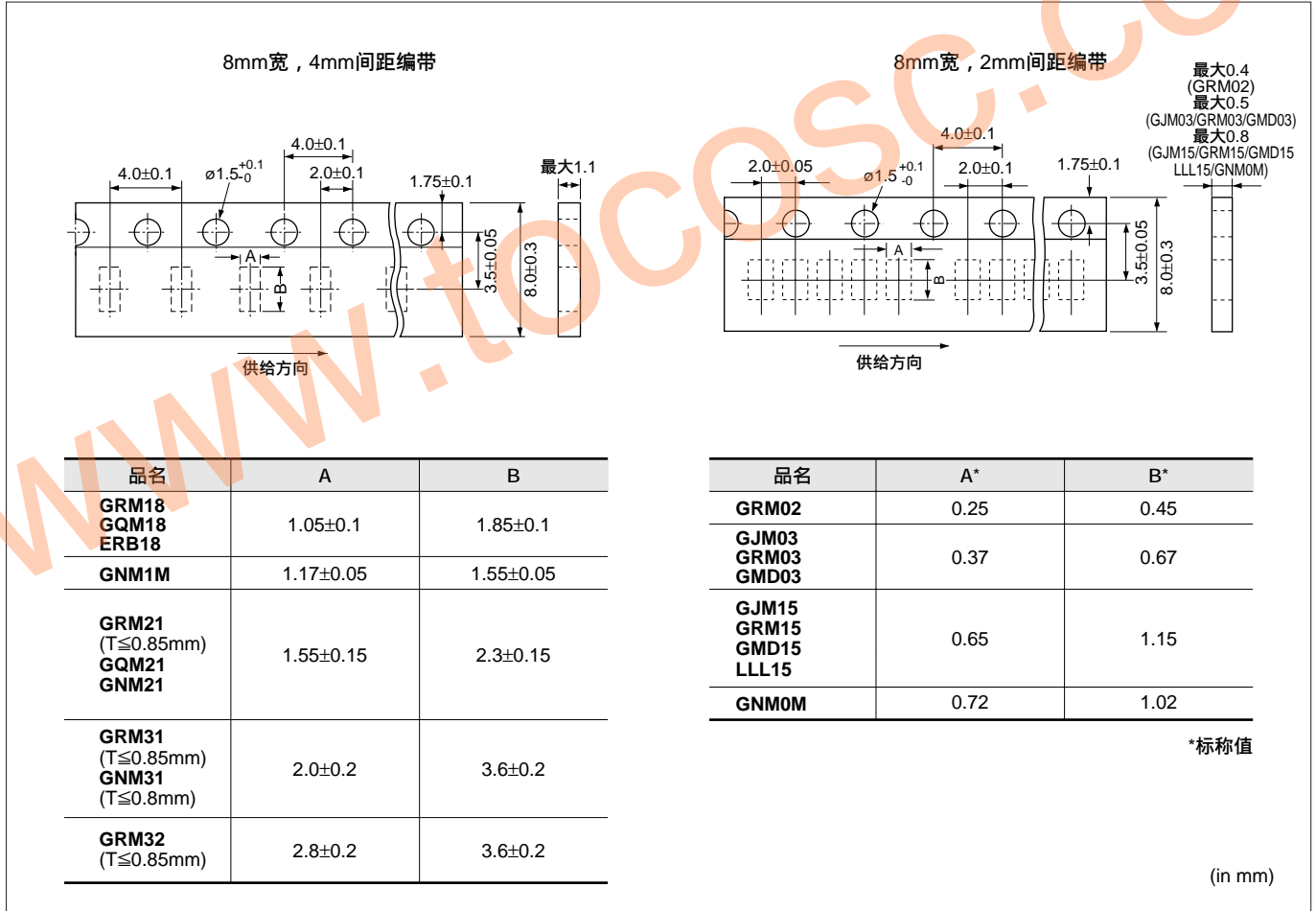

接下一页。

包装

接上页。

(3) 压纹带尺寸

4mm宽, 1mm间距编带

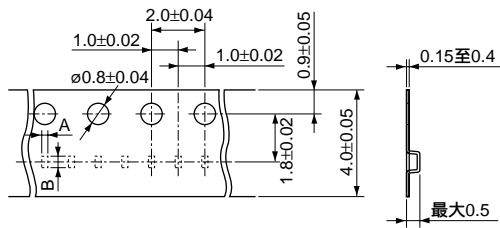

品名	A*	B*
GRM02	0.23	0.43

*标称值

*GRM03也有使用4mm宽1mm间距的编带包装。

12mm宽, 8mm间距编带

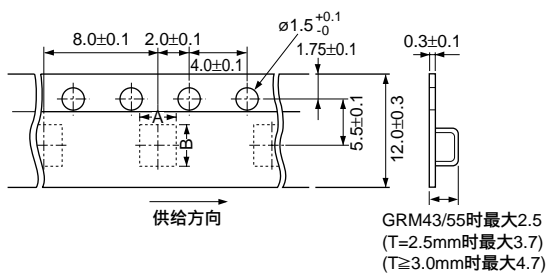

品名	A*	B*
GRM43	3.6	4.9
GRM55	5.2	6.1

*标称值

(in mm)

8mm宽, 4mm间距编带

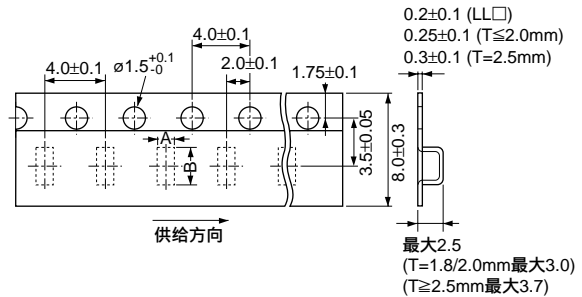

品名	A	B
LLL18, LLA18	1.05±0.1	1.85±0.1
GRM21 (T≥1.0mm) LLL21 LLA21, LLM21	1.45±0.2	2.25±0.2
ERB21	1.55±0.2	2.3±0.2
GRM31 (T≥1.15mm) LLL31 LLA31, LLM31 GNM31 (T≥1.0mm)	1.9±0.2	3.5±0.2
GRM32, ERB32 (T≥1.0mm)	2.8±0.2	3.5±0.2

(4) 编带方法

电容器编带按顺时针方向缠绕。编带向您拉出时，定位孔位于右侧。

部分引导带及部分空白带应如下贴在编带末端。

上胶带和底带至少有5个脚距的部分不能贴在编带末端。

短缺的电容器在每个卷盘中0.1%以内或不能超过1件(以较大者为准)，而且不能连续发生。

上胶带和下胶带不应超出编带边缘，而且不能覆盖定位孔。

定位孔累计偏差，以10个脚距计: ±0.3mm

剥离力: 在以下所示方向为0.1至0.6N*。

*GRM02 }
 GRM03 } : 0.05至0.5N
 GJM03 }
 GMD03 }

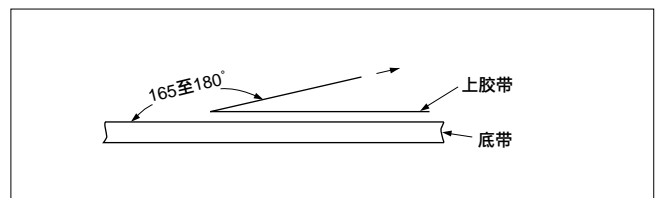
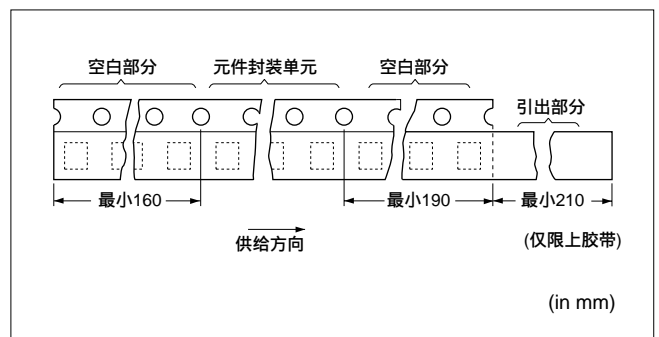

接下页。

包装

☐ 接上页。

散装盒包装尺寸

散装盒采用防静电材料。详情请与村田公司联系。

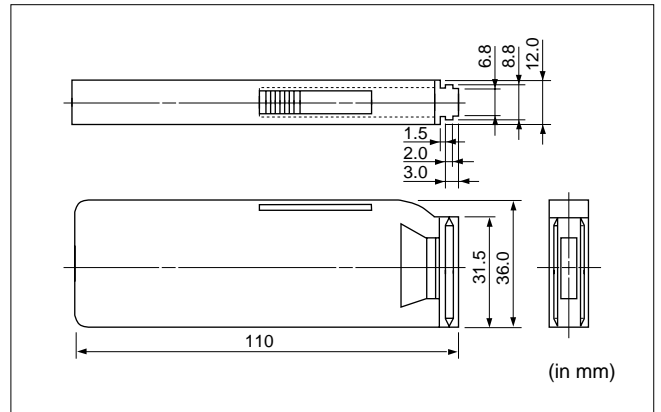

www.tocosc.com



■ 存放与使用条件

1. 片状独石陶瓷电容器的性能可能会受到存放条件的影响。

1-1. 在下列条件下存放电容器：

温度为5 到40 ，相对湿度为20%到70%。

- (1) 保管期间的日照、灰尘、温度急剧变化、腐蚀性气体或高温和高湿等可能会影响其可焊性及封装性能。请在交货后6个月内使用。
- (2) 超过6个月后，使用前请确认其可焊性。存放电容器时不要打开原包装袋。即使存放时间很短，也不要超过规定的环境条件。

- 1-2. 腐蚀性气体可能会对外部电极或电容器引线产生影响，导致可焊性变差。切勿在在腐蚀性气体 (例如硫化硫、二氧化硫、氯气和氨气等) 环境中存放电容器。
- 1-3. 由于湿度急剧变化引起的水气凝结或阳光直射引起外部电极、树脂、环氧涂层产生光化学变化，都会导致可焊性和电气性能变差。切勿在阳光直射或高温条件下存放电容器。

www.tocosc.com

警告

■ 额定值

1. 温度依赖特性

1. 电容器的电气特性会随温度而变化。

1-1. 对于具有较大温度依赖性的电容器，其静电容量可能会随温度变化而变化。

为了确保获得合适的电容值，建议采取以下措施。

(1) 选择在工作温度范围内合适的静电容量。

(2) 该静电容量可能会在额定温度范围内变化。

您在需要电容容量变化小的电路中使用高介电常数型电容器时，例如时间常数电路，请仔细考虑此类电容器的特性，例如其老化、电压和温度特性。并在预期环境和工作条件下使用实际设备测试电容器。

典型温度特性图 R6(X5R)

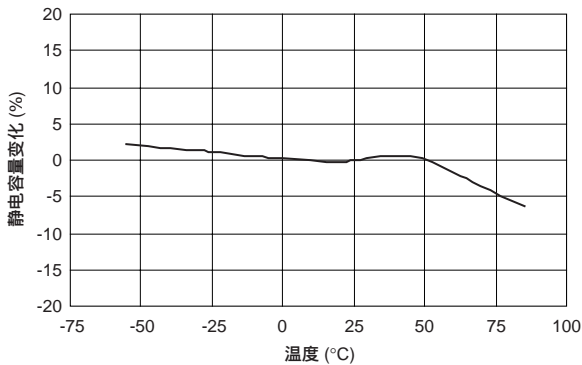

典型温度特性图 R7(X7R)

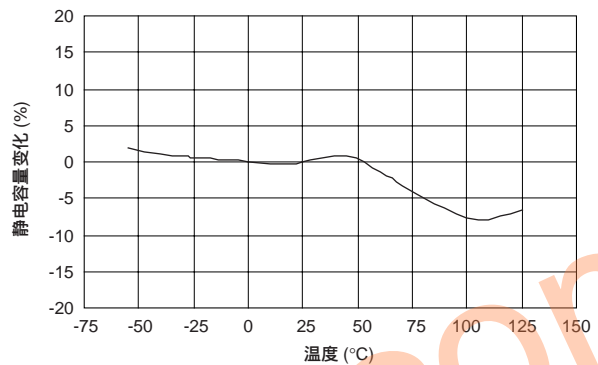

典型温度特性图 F5(Y5V)

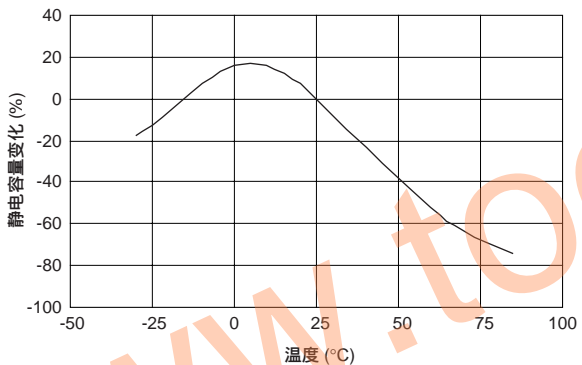

2. 静电容量测量

1. 在产品规格规定的电压和频率下测量静电容量。

1-1. 测量大容量电容时，有时会导致测量设备输出电压降低，从而引起测量误差。请确认实际施加于电容器上的电压是否符合指定条件。

1-2. 高介电常数型电容器的静电容量会随施加的交流电压而变化。选择在交流电路中使用的电容器时，请考虑交流电压特性。

接下一页。



☐ 接上页。

3. 施加电压

1. 向电容器施加的电压切勿超过其规定的额定电压。

1-1. 电容器外部电板之间的施加电压应小于或等于额定电压。

(1) 交流电压与直流电压叠加时，峰值不应超过额定直流电压。

施加交流电压或脉冲电压时，峰峰值不应超过额定直流电压。

(2) 异常电压 (浪涌电压、静电和脉冲电压等) 不应超过额定直流电压。

施加到电容器上的典型电压

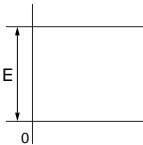
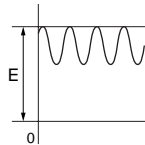
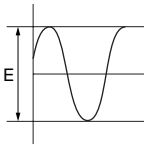
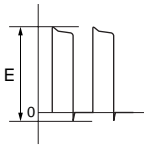
直流电压	直流电压 + 交流电压	交流电压	脉冲电压
			

(E:可能施加的最大电压)

1-2. 过电压影响

施加到电容器的过电压可能会导致电容器内部介电层击穿而引起电气短路。

击穿前的可持续时间取决于施加电压和周围温度。

4. 施加电压和自发热温度

1. 当电容器应用在高频电压、脉冲电压下时，必需考虑到电容器的电阻因素可能会引起的自发热。

1-1. 负荷应达到以下水平：周围温度为25 时进行测量时，产品自发热保持20 以下，实际电路中的电容器表面温度保持在最高工作温度范围内。

☐ 接下页。

警告

接上页。

5. 直流电压和交流电压特性

1. 高介电常数型电容器的静电容量会随施加的直流电压而变化。

选择在直流电路中使用的电容器时，请考虑直流电压特性。

1-1. 陶瓷电容器的静电容量可能会随施加电压发生急剧变化。(参见图)

为了确保静电容量，请确认以下情况。

- (1) 施加电压引起的静电容量变化是否处于允许值范围内。
- (2) 在直流电压特性方面，静电容量变化率会随着电压增加而变得更大。即使施加电压低于额定电压，高介电常数型电容器在需要静电容量变化小的电路中时，例如时间常数电路，请仔细考虑此类电容器的特性，例如其老化、电压和温度特性。并在预期环境和工作条件下使用实际设备测试电容器。

2. 高介电常数型电容器的静电容量会随施加的交流电压而变化。

选择在交流电路中使用的电容器时，请考虑交流电压特性。

6. 电容老化

1. 高介电常数型电容器有一个特性，即静电容量会随时间推移而降低。

您在需要静电容量变化小的电路中使用高介电常数型电容器时，例如时间常数电路，请仔细考虑此类电容器的特性，例如其老化、电压和温度特性。并在预期环境和工作条件下使用实际设备测试电容器。

[直流电压特性]

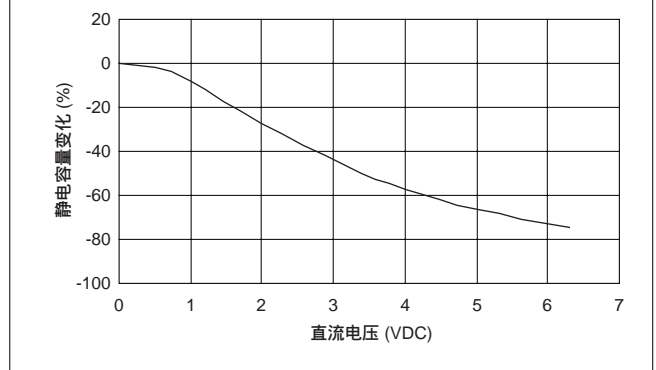

[交流电压特性]

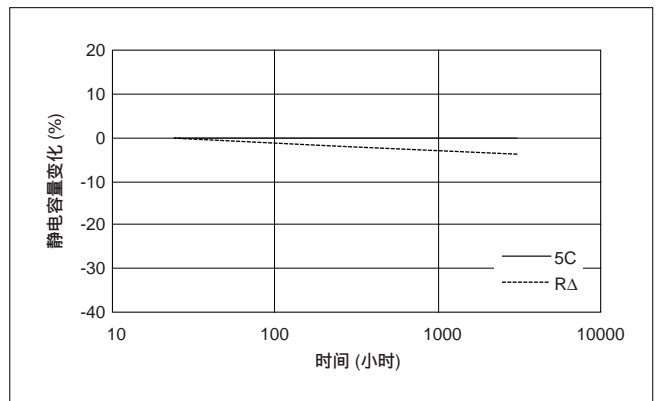
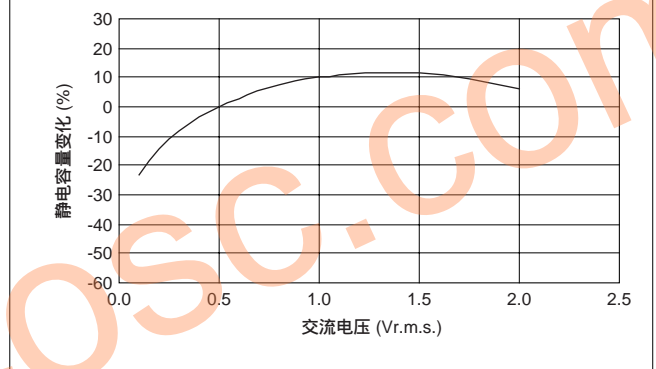

接下页。



☐ 接上页。

7. 振动和冲击

1. 应根据使用环境规定电容器机械应力 (振动和冲击)。
请确认振动和/或冲击类型、条件和谐振产生。
请在安装电容器时避免产生谐振。不允许对端子产生任何影响。
2. 坠落形成的机械冲击可能会导致电容器的介质材料损坏或破裂。
切勿使用坠落后的电容器，因为其质量和可靠性可能已变差。
3. 印刷电路板堆放或搬运时，请勿用另一印刷电路板边角撞击电容器，以免造成电容器破裂或损坏。

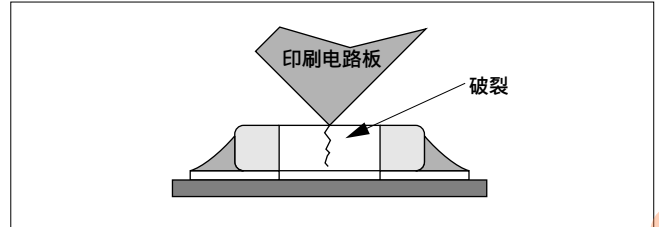
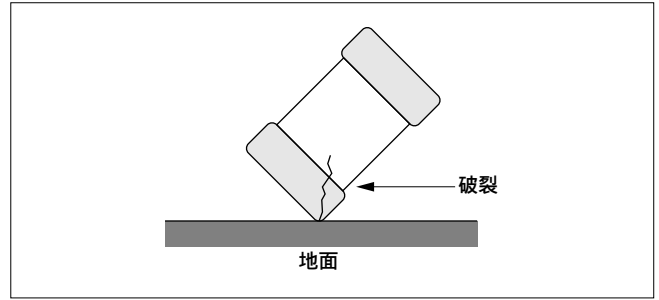

www.tocosc.com

警告

■ 焊接与安装

1. 安装位置

1. 应选择适当的安装位置和方向，以使电路板弯折时施加在该电容器上的应力最小。

1-1. 请选择PCB弯曲或挠曲时元件承受压力最小的位置进行安装。

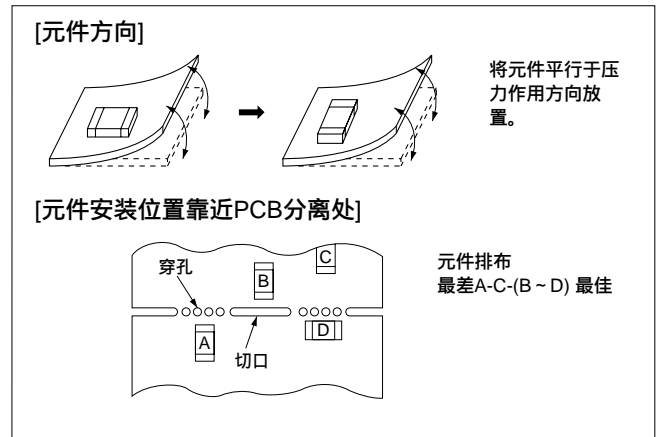

2. 安装前信息

1. 切勿再次使用从设备上拆卸下的电容器。
2. 确认实际电压下的静电容量特性。
3. 确认实际过程中和设备使用下的机械应力。
4. 装配之前，确认额定静电容量、额定电压和其他电气特性。
5. 电容器经过长期存放后，使用前请确认其可焊性。
6. 电容器经过长期存放后，测量经典容量前需进行预热。

7. 使用Sn-Zn基焊料会严重影响MLCC的可靠性。
 有关Sn-Zn基焊料的使用，请事先向村田制作所咨询。

3. 贴片设备维护

1. 确保不向电容器施加以下过大的力量。
 - 1-1. 在印刷电路板上贴装电容器时，应保持施加最小的弯曲力，以防出现任何弯曲造成的损坏或破裂。使用过程中，请考虑以下预防措施和建议。
 - (1) 调节吸嘴的最低位置，以免弯曲印刷电路板。
 - (2) 贴装时将吸嘴压力调节在1N到3N的静载荷范围内。
 2. 吸嘴与圆柱内壁之间沉积的尘土颗粒及粉尘会使吸嘴移动不畅。这会在贴装时对芯片施加较大的力量，从而导致芯片损坏。定位爪磨损后会在定位时对芯片用力不均，从而导致芯片破损。吸嘴及定位爪必须定期维修、检查更换。

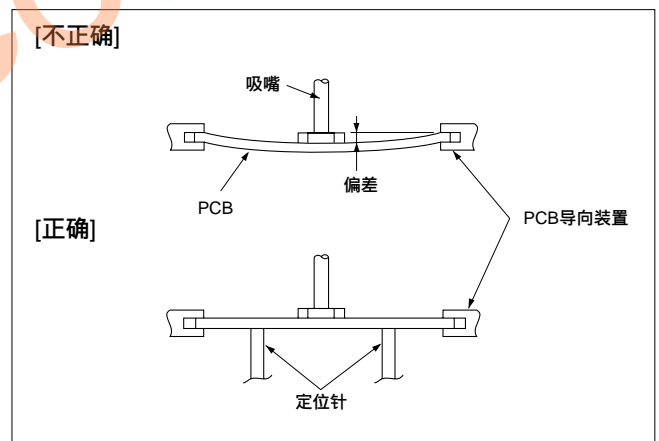

接下页。



☐ 接上页。

4-1. 回流焊接

1. 如果元件突然受热，则会降低其机械强度。原因是较大的温度变化会导致内部变形。为防止造成机械损坏，应对元件和PCB板进行预热。

有关预热条件的说明，请参见表1。应保持焊锡温度与元件表面温度之间的温差 (ΔT) 尽可能小。

2. 当焊接温度低于锡的熔点时，芯片镀锡端子的可焊性将下降。使用之前请确认芯片镀锡电极的可焊性。
3. 当元件贴装后浸泡在溶剂时，务必将元件与溶剂之间的温差 (ΔT) 维持在表1所示的范围内。

表1

品名	温差
GRM02/03/15/18/21/31 GJM03/15 LLL15/18/21/31 ERB18/21 GQM18/21	$\Delta T \leq 190^\circ\text{C}$
GRM32/43/55 LLA18/21/31 LLM21/31 GNM ERB32	$\Delta T \leq 130^\circ\text{C}$

建议采用条件

	Pb-Sn焊接		无铅焊接
	红外回流	蒸汽回流	
峰值温度	230至250°C	230至240°C	240至260°C
环境	空气	空气	空气或氮气

Pb-Sn焊料: Sn-37Pb
 无铅焊料: Sn-3.0Ag-0.5Cu

[回流焊接的标准条件]

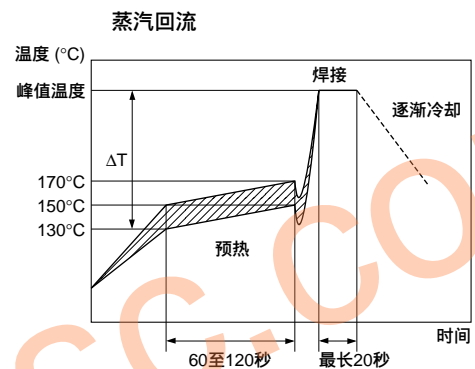
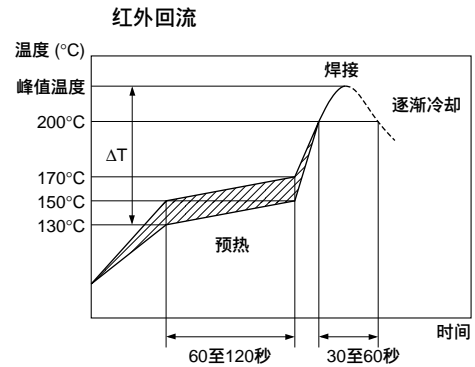

[允许焊接温度及时间]

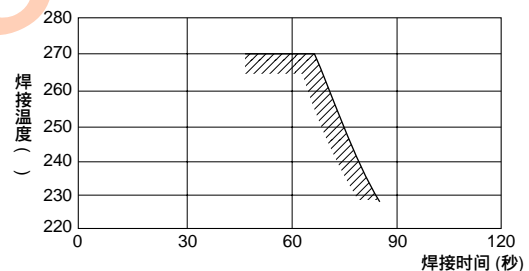

若是重复焊接，则累计焊接时间必须在以上所示的范围内。

4. 回流焊接的最佳焊料用量

- 4-1. 使用的锡膏过厚会导致焊接圆角偏高。这会使PCB上的芯片更易受机械及热应力影响，而且可能导致芯片破损。
- 4-2. 锡膏太少会造成与外部电极结合强度不够，从而导致芯片从PCB上脱落。
- 4-3. 务必使锡膏均匀分布在端子表面上，厚度至少为0.2mm*。

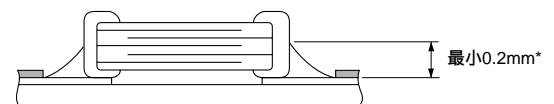

* GRM02/03: 元件最小厚度的1/3。

剖面图

倒置PCB

勿使PCB承受异常机械冲击。

接下一页。☐

警告

☐ 接上页。

4-2. 波峰焊接

1. 如果元件突然受热，则会降低其机械强度。原因是较大的温度变化会导致内部变形。为防止造成机械损坏，应对元件和PCB板进行预热。
 有关预热条件的说明，请参见表2。应保持焊锡温度与元件表面温度之间的温差 (ΔT) 尽可能小。
2. 焊接时间过长或温度过高会造成外部电极浸析，从而会因电极与外部端子之间接触不良而导致结合不牢，或静容量值降低。
3. 当元件贴装后浸泡在溶剂时，务必将元件与溶剂之间的温差 (ΔT) 维持在表2所示的范围内。
4. 请勿对表2未列出的元件进行波峰焊接。

表2

品名	温差
GRM18/21/31	$\Delta T \leq 150^\circ\text{C}$
LLL21/31	
ERB18/21	
GQM18/21	

建议采用条件

	Pb-Sn焊接	无铅焊接
预热峰值温度	90至110°C	100至120°C
焊接峰值温度	240至250°C	250至260°C
环境	空气	氮气

Pb-Sn焊料: Sn-37Pb

无铅焊料: Sn-3.0Ag-0.5Cu

5. 波峰焊接的最佳焊料用量

- 5-1. 焊接圆角顶部应低于元件的厚度。如果焊料量过大，则在弯曲或其他应力条件下元件存在很大的断裂危险。

[波峰焊接的标准条件]

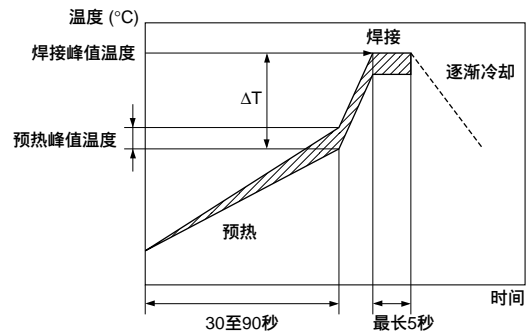

[允许波峰焊接温度及时间]

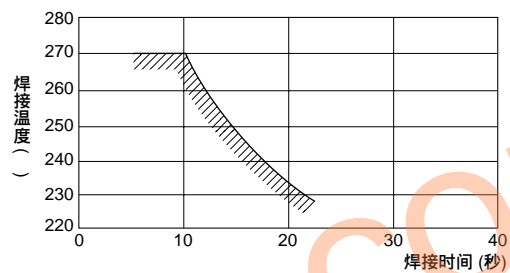

若是重复焊接，则累计焊接时间必须在以上所示的范围内。

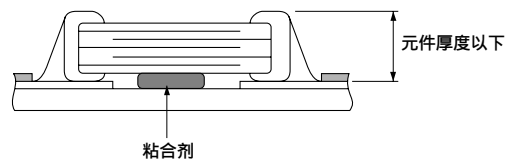

剖面图

☐ 接下页。



☐ 接上页。

4-3. 使用烙铁进行校正

1. 当使用烙铁时元件突然受热，则会降低其机械强度。原因是较大的温度变化会导致元件内部变形。为防止造成机械损坏，应对元件和PCB板进行预热。预热条件 ("烙铁头温度"、"预热温度"、"烙铁头与元件和PCB之间的温差") 应该处于表3的条件范围内。应将烙铁与元件表面之间的温差 (ΔT) 保持尽可能小。
2. 焊接后，切勿使元件/PCB快速冷却。
3. 返修的工作时间应尽可能短。返修时间太长时，可能会导致焊料浸析，从而会导致外部端子粘合强度降低。
4. 使用烙铁返修时的最佳焊料量
 - 4-1. 如果尺寸小于 0603 (GRM03/15/18、GJM03/15、GQM18、ERB18)，那么焊锡圆角顶部应小于元件厚度的2/3或0.5mm (较小者为准)。如果尺寸为0805和更大尺寸 (GRM21/31/32/43/55、GQM21、ERB21/32)，那么焊锡圆角顶部应小于元件厚度的2/3。如果焊料量过大，则在弯曲或其他应力条件下存在很大的断裂危险。
 - 4-2. 要求使用 $\phi 3\text{mm}$ 或更小直径的烙铁头。返修过程中需要防止烙铁直接接触元件。
 - 4-3. 应使用 $\phi 0.5\text{mm}$ 或更细的焊条进行焊接。

表3

品名	烙铁头温度	预热温度	温差	环境
GRM03/15/18/21/31 GJM03/15 GQM18/21 ERB18/21	350°C max.	150°C min.	$\Delta T \leq 190^\circ\text{C}$	空气
GRM32/43/55 ERB32	280°C max.	150°C min.	$\Delta T \leq 130^\circ\text{C}$	空气

*Pb-Sn焊料和无铅焊料均可使用。
 Pb-Sn焊料:Sn-37Pb
 无铅焊料:Sn-3.0Ag-0.5Cu

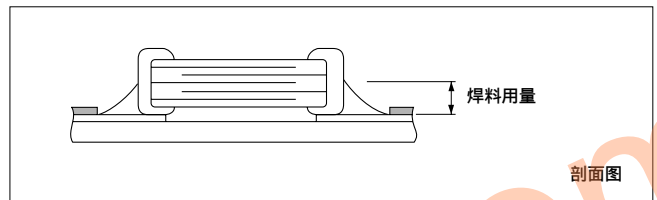

4-4. 引脚元件的插接

1. 贴装引脚元件 (例如变压器与IC等) 时如果PCB弯曲，则芯片可能会破损，而且焊缝开裂。
 贴装引脚元件前，请用定位针或专门的夹具固定PCB以免发生扭曲。

5. 清洗

清洗时若超音波振荡过大会导致PCB产生共振，从而造成芯片破损或焊缝开裂。请注意不要振动PCB。

6. 印刷电路板电气试验

1. 将电容器安装在印刷电路板后，检验电容器的电气性能时，确认定位针或专用夹具的位置。
 - 1-1. 避免试验针等的压力弯曲印刷电路板。
 测试探针的推力可使PCB发生弯曲，从而导致芯片破损或焊缝开裂。
 请在PCB背面提供定位针，以免发生扭曲或弯曲。
 - 1-2. 试验针接触印刷电路板时，避免冲击引起的印刷电路板振动。

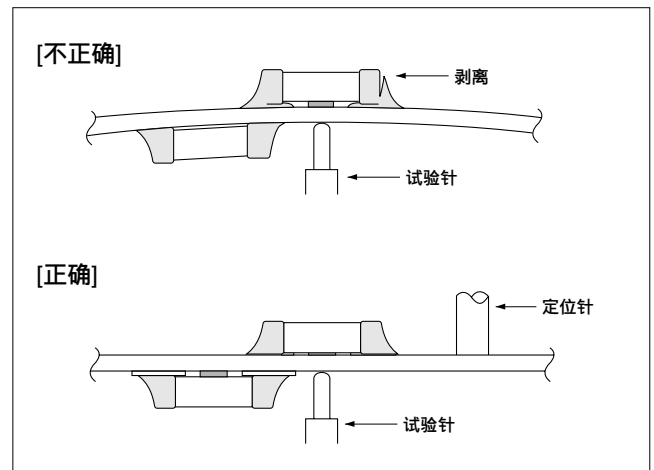

☐ 接下页。

警告

☐ 接上页。

7. 印刷电路板裁切

1. 在印刷电路板上贴装电容器后，不要通过弯曲或扭曲该板向电容器施加任何应力。

1-1. 裁切该板时，右图所示弯曲或扭曲电路板可能会导致电容器断裂。

不要向电容器施加这种类型的应力。

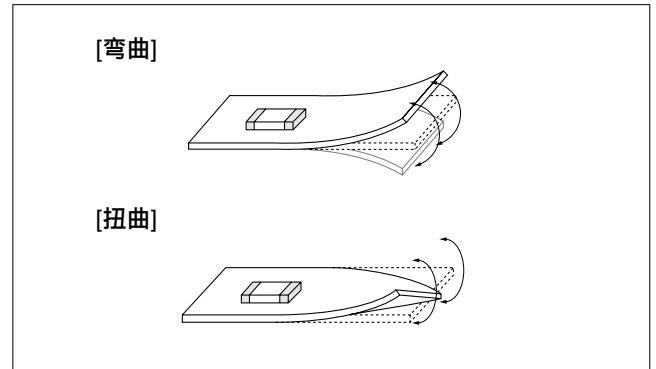

2. 预先检查印刷电路板的裁切方法。

2-1. 应使用夹具或设备进行印刷电路板裁切，以防印刷电路板受到机械应力。

(1) 适当夹具示例

正确示例：应该从板背面推动印刷电路板，并尽可能靠近剪切夹具，从而使施加到电容器的压力最小化。

不正确示例*：如下所示从板正面推动印刷电路板，并作用于远离剪切夹的一个点时，电容器可能会由于外部应力导致断裂。

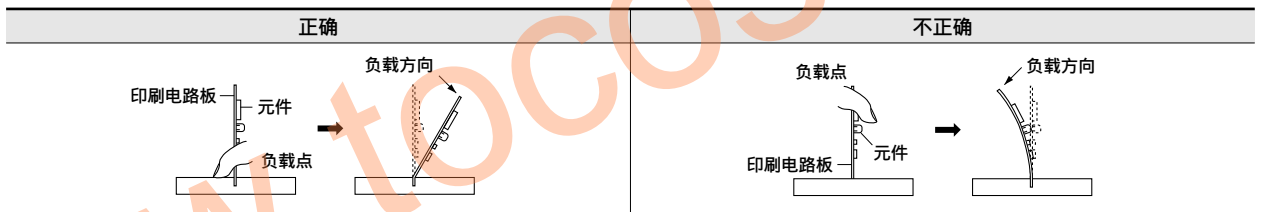
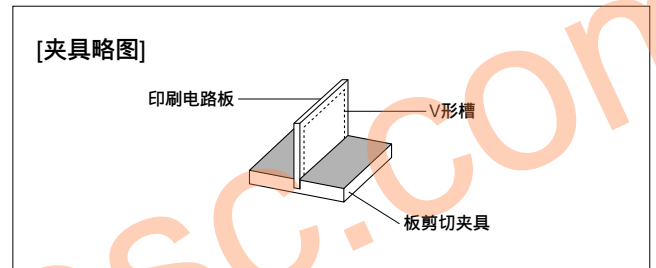

接下页。 ☐



☐ 接上页。

(2) 适当设备示例

印刷电路板剪切设备略图如下所示。沿着印刷电路板上的V形槽直线方向剪切电路板顶部刀片和底部刀片彼此对准。

顶部刀片和底部刀片位置偏离可能会导致电容器断裂。

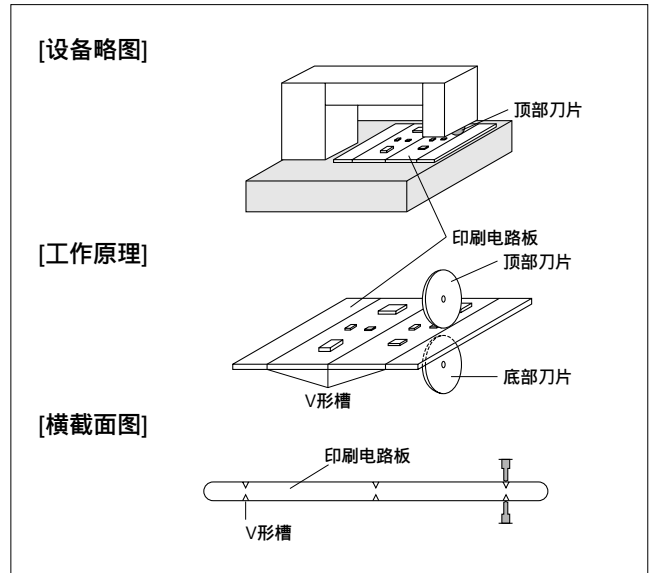

正确	不正确		
	上下偏离	左右偏离	前后偏离
<p>顶部刀片</p> <p>底部刀片</p>	<p>顶部刀片</p> <p>底部刀片</p>	<p>顶部刀片</p> <p>底部刀片</p>	<p>顶部刀片</p> <p>底部刀片</p>

www.tocos.com

警告

■ 其他

1. 设备运行时

- 1-1. 设备运行期间，切勿用裸手直接触摸电容器，以免发生电击危险。
- 1-2. 切勿使电容器端子接触任何导电物体（短路）。
切勿使电容器暴露于导电液体中，包括任何酸溶液或碱溶液。
- 1-3. 确认设备工作环境符合规定条件。
切勿在以下环境中使用该设备。
 - (1) 飞溅到水或油。
 - (2) 受阳光直射。
 - (3) 暴露于臭氧、紫外线或辐射中。
 - (4) 暴露于毒气（例如硫化氢、二氧化硫、氯气和氨气等）中。
 - (5) 超过规定限制的任何振动或机械冲击。
 - (6) 水气凝结环境。
- 1-4. 若在可能产生凝结的任何条件下使用，则需采用防潮措施。

2. 其他

2-1. 紧急情况下

- (1) 如果设备产生烟雾、火灾或异味，应立即关闭设备

或拔下设备插头。

如果未关闭设备或拔下设备插头，继续供电可能会造成更严重的危险。

- (2) 在此类情况下，不允许脸和手接触电容器，否则会被电容器的高温灼伤。

2-2. 废物处置

处置电容器时，必须由具有适当执照的工业废物处理商进行焚烧或掩埋。

2-3. 电路设计

本产品目录中所列的GRM, GCM, GMA/D, LLL/A/M, ERB, GQM, GJM, GNM系列电容器为非安全规格认证品。

2-4. 备注

使用本产品时如忽略警告事项，则在严重情况下可能导致产品短路及冒烟。

以上注意事项针对标准用途及标准适用条件。如果产品用于特殊的贴装条件，请与我们联系。

请选择最佳的工作条件，这些条件的好坏可决定产品贴装后使用的可靠性。

本目录中的数据为典型值，并非保证额定值。

注意事项

■ 额定值

1. 工作温度

1. 工作温度限制视电容器而定。

1-1. 切勿应用于超过工作温度上限的温度。

需要选择能覆盖工作温度范围并具有适当额定温度的电容器。

同样必需考虑设备温度分布和季节温度变化因素。

1-2. 考虑电容器自发热

自发热因素计算在内时，电容器表面温度应为工作温度上限或略低。

2. 周围环境 (气体和液体)

1. 电容器工作环境限制。

1-1. 在上述不适当的环境中使用电容器时，由于端子腐蚀，水气渗入，电容器的性能可能会变差。

1-2. 电容器的电极或端子遭受水气凝结时，可能会出现上述相同现象。

1-3. 电容器长时间暴露于腐蚀性气体、挥发气体或溶剂时，端子电极氧化或腐蚀引起电容器的特性和绝缘阻抗变差，可能会导致电容器击穿。

3. 压电现象

1. 在交流电路或脉冲电路中使用高介电常数类型电容器时，在特定频率时电容器本身会振动，并可能会产生噪声。

此外，电容器受到机械振动或冲击时，也可能产生噪声。

www.tocosc.com

注意事项

■ 焊接与安装

1. PCB设计

1. 布局注意事项

- 1-1. 与引脚元件不同的是，片状元件由于直接贴装于基片上，因此易受弯曲应力影响。而且它们对机械及热应力比引脚元件更敏感。焊接圆角过高会加大此类应力，从而导致元件破损。因此在设计基片时，请考虑焊盘布局及尺寸，以免焊接圆角偏高。
- 1-2. 有可能发生由于金属板的膨胀和收缩导致的元件裂纹。如果您想要在金属板（例如铝）上使用陶瓷电容器，请与我们联系。

布局

	不正确	正确
靠近底盘贴装		
贴装片状元件及引脚元件		
在片状元件之后贴装引脚元件		
横向贴装		

接下页。

注意事项

☐ 接上页。

2. 焊盘尺寸

2-1. 如果焊盘面积过大，焊料使用过多，那么由于PCB弯曲等应力，片状电容器可能出现断裂。
 关于波峰焊接请参见表1的焊盘尺寸，关于回流焊接请参见表2，关于GNM和LLA请参见表3，关于LLM请参见表4。
 请通过评估实际SET/PCB确认适当的焊盘尺寸。



表1 波峰焊接方式

品名	尺寸	尺寸(长×宽)	a	b	c
GRM18 GQM18		1.6×0.8	0.6 to 1.0	0.8 to 0.9	0.6 to 0.8
GRM21 GQM21		2.0×1.25	1.0 to 1.2	0.9 to 1.0	0.8 to 1.1
GRM31		3.2×1.6	2.2 to 2.6	1.0 to 1.1	1.0 to 1.4
LLL21		1.25×2.0	0.4 to 0.7	0.5 to 0.7	1.4 to 1.8
LLL31		1.6×3.2	0.6 to 1.0	0.8 to 0.9	2.6 to 2.8
ERB11		1.25×1.0	0.4 to 0.6	0.6 to 0.8	0.8 to 1.0
ERB21		2.0×1.25	1.0 to 1.2	0.9 to 1.0	0.8 to 1.0
ERF1D		1.4×1.4	0.5 to 0.8	0.8 to 0.9	1.0 to 1.2

(in mm)

表2 回流焊接方式

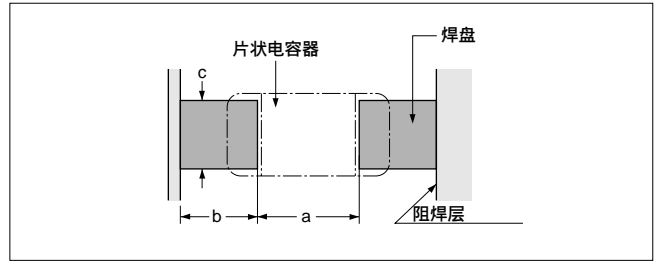
品名	尺寸	尺寸(长×宽)	a	b	c
GRM02		0.4×0.2	0.16 to 0.2	0.12 to 0.18	0.2 to 0.23
GRM03 GJM03		0.6×0.3	0.2 to 0.3	0.2 to 0.35	0.2 to 0.4
GRM15 GJM15		1.0×0.5	0.3 to 0.5	0.35 to 0.45	0.4 to 0.6
GRM18 GQM18		1.6×0.8	0.6 to 0.8	0.6 to 0.7	0.6 to 0.8
GRM21 GQM21		2.0×1.25	1.0 to 1.2	0.6 to 0.7	0.8 to 1.1
GRM31		3.2×1.6	2.2 to 2.4	0.8 to 0.9	1.0 to 1.4
GRM32		3.2×2.5	2.0 to 2.4	1.0 to 1.2	1.8 to 2.3
GRM43		4.5×3.2	3.0 to 3.5	1.2 to 1.4	2.3 to 3.0
GRM55		5.7×5.0	4.0 to 4.6	1.4 to 1.6	3.5 to 4.8
LLL15		0.5×1.0	0.15 to 0.2	0.2 to 0.25	0.7 to 1.0
LLL18		0.8×1.6	0.2 to 0.3	0.3 to 0.4	1.4 to 1.6
LLL21		1.25×2.0	0.4 to 0.6	0.4 to 0.5	1.4 to 1.8
LLL31		1.6×3.2	0.6 to 0.8	0.6 to 0.7	2.6 to 2.8
ERB11		1.25×1.0	0.4 to 0.6	0.6 to 0.8	0.8 to 1.0
ERB21		2.0×1.25	1.0 to 1.2	0.6 to 0.8	0.8 to 1.0
ERB32		3.2×2.5	2.2 to 2.5	0.8 to 1.0	1.9 to 2.3
ERF1D		1.4×1.4	0.4 to 0.8	0.6 to 0.8	1.0 to 1.2
ERF22		2.8×2.8	1.8 to 2.1	0.7 to 0.9	2.2 to 2.6

(in mm)

接下一页。 ☐

注意事项

接上页。



表3 GNM, LLA系列回流焊接的焊盘尺寸

品名	尺寸 (mm)					
	长	宽	a	b	c	p
GNM0M2	0.9	0.6	0.12至0.20*	0.35至0.40*	0.3	0.45
GNM1M2	1.37	1.0	0.4至0.5	0.35至0.45	0.3至0.35	0.64
GNM212	2.0	1.25	0.6至0.7	0.5至0.7	0.4至0.5	1.0
GNM214	2.0	1.25	0.6至0.7	0.5至0.7	0.25至0.35	0.5
GNM314	3.2	1.6	0.8至1.0	0.7至0.9	0.3至0.4	0.8
LLA18	1.6	0.8	0.3至0.4	0.25至0.35	0.15至0.25	0.4
LLA21	2.0	1.25	0.5至0.7	0.35至0.6	0.2至0.3	0.5
LLA31	3.2	1.6	0.7至0.9	0.4至0.7	0.3至0.4	0.8

* 0.82 ≤ a+2b ≤ 1.00

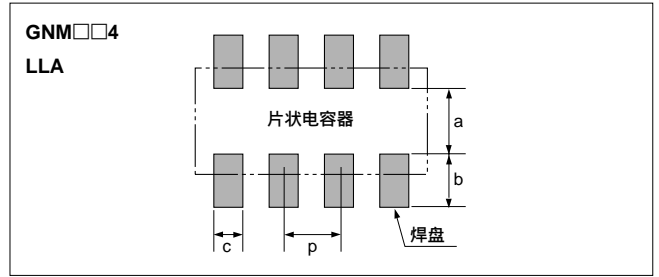
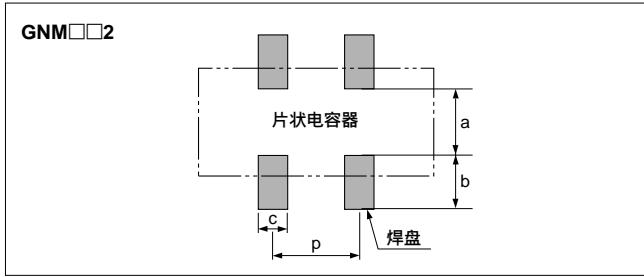

表4 LLM系列回流焊接的焊盘尺寸

品名	尺寸 (mm)						
	a	b, b'	c, c'	d	e	f	p
LLM21	0.6至0.8	(0.3至0.5)	0.3	2.0至2.6	1.3至1.8	1.4至1.6	0.5
LLM31	1.0	(0.3至0.5)	0.4	3.2至3.6	1.6至2.0	2.6	0.8

b=(c-e)/2, b'=(d-f)/2

2. 粘合剂的使用

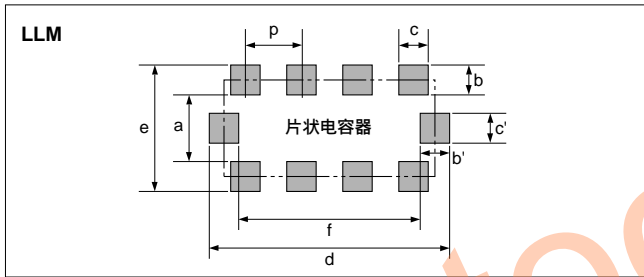
1. 粘合剂过薄或用量不足会导致元件在波峰焊接时松动或脱落。粘合剂的用量应大于右图所示尺寸C，以达到足够的粘结强度。

必须同时考虑到元件的电极厚度及焊盘厚度。

2. 低粘性粘合剂会导致元件在贴装后滑动。粘合剂的粘性必须最少达到5000Pa·s (500ps) (25°C时)。

3. 粘合剂用量

品名	粘合剂用量*
GRM18, GQM18	最少0.05mg
GRM21, LLL21, GQM21	最少0.1mg
GRM31, LLL31	最少0.15mg

*标称值

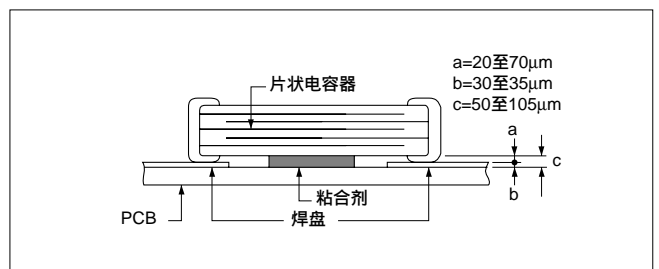

接下页。

注意事项

☐ 接上页。

3. 粘合剂固化

1. 粘合剂固化不充分会导致芯片在波峰焊接时脱落，而且使外部电极之间因吸湿而造成绝缘电阻下降。
请控制好固化温度及时间以免固化不充分。

4. 助焊剂的使用

1. 助焊剂用量过大会产生大量的气体，从而导致可焊性降低。
因此应在整个过程中均匀使用少量的助焊剂。(波峰焊接一般采用发泡系统)。
2. 助焊剂中卤化物含量太高可能会导致外部电极腐蚀，除非经过充分的清洗。使用最大卤化物含量为0.2%的助焊剂。

3. 请勿使用强酸性助焊剂。
4. 请勿使用水溶性助焊剂。
(*水溶性助焊剂可定义为非树脂型助焊剂，包括水洗型和非水洗型助焊剂)

5. 波峰焊接

注意温度及时间，以确保外部电极的沥滤不会超过单个元件终端面积(即如右所示A-B-C-D面的全长)的25%，以及贴在基片上时如下所示A-B长度的25%。

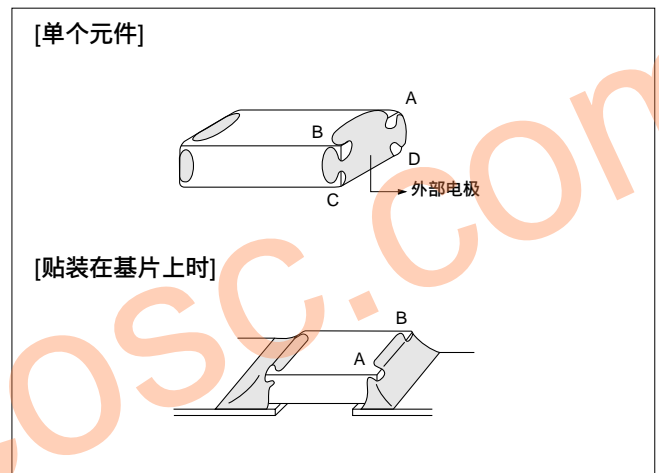

6. 清洗

1. 请通过实际清洁设备和确认质量的安全条件来评价电容器，然后选择适当的溶剂。
2. 不适当的清洗溶剂可能会留下残留助焊剂和其他杂质，从而导致电容器的电气特性和可靠性变差。

3. 选择合适的清洗条件。
3-1. 不当清洗条件(过度或不足)可能会致使电容器性能变差。

7. 涂层

1. 固化处理过程中，树脂热收缩应力可能会致使电容器产生断裂。
这种应力受树脂量和固化收缩力的影响。
选择固化收缩小的树脂。
涂层树脂或成型树脂和电容器之间的热膨胀系数差异，可能会导致电容器损坏或变差，例如断裂或剥离，并导致绝缘阻抗变差或介质击穿。

- 选择热膨胀系数尽可能接近电容器热膨胀系数的树脂。
硅酮树脂可用作内涂层，以缓解应力。
2. 选择吸湿较少的树脂。
在高湿条件下使用吸湿树脂，可能会致使电容器绝缘阻抗变差。
所有环氧树脂都可用作吸湿较少的树脂。

☐ 接下页。

注意事项

☐ 接上页。

8. 元件结合 / 引线结合 (GMA或GMD系列)

1. 电容器的元件结合

- 使用以下的铜焊合金材料:
Au-Sn (80/20)，在300至320°C氮气环境下
- 贴装
 - (1) 控制好基片温度，使其与铜焊合金的温度一致。
 - (2) 先将铜焊合金放在基片上，再在合金上放置电容器。
请抓住电容器，轻轻用力。操作务必在1分钟内完成。

2. 引线结合

- 引线
金线: 直径25 μ m (0.001英寸)
- 结合
 - (1) 热压、超声球焊。
 - (2) 所需平台温度: 150至200°C
 - (3) 所需力度: 0.2N至0.5N
 - (4) 将电容器与基片或其他装置用金线结合。

www.tocosc.com

注意事项

■ 其他

1. 运输

1. 运输过程中的各种条件都可能会影响到电容器的性能。

1-1. 运输过程中电容器应该防止超温、湿气和机械力。

(1) 气候条件

- 低空气温度: - 40°C
- 空气/空气温度变化: - 25°C到 + 25°C
- 低气压: 30 kPa
- 气压变化: 6 kPa/秒

(2) 机械条件

运输应在外包装箱不变形，不受外部力量直接作用的方式下完成。

1-2. 切勿向电容器施加过度振动、冲击或压力。

- (1) 向电容器施加过度机械振动或压力时，电容器陶瓷体可能会发生破碎或断裂。
- (2) 空气驱动装置、烙铁、小钳和底盘等的锐边会强烈碰撞电容器表面时，电容器可能会断裂或短路。

1-3. 切勿使用因坠落受到过度冲击的电容器。

处理过程中意外坠落的电容器可能已损坏。

www.tocosc.com

参考资料

1. 可焊性

(1) 测试方法

将片状电容器置于以下条件。

然后在元件上涂上助焊剂 (25%松香的乙醇溶液)，再将其浸泡在230°C共晶锡2秒。

条件:

在常温下裸露 (时间分别为6个月及12个月)

放置于高温条件下 (85°C下100小时)

放置于潮湿条件下 (40°C时在90%至95%相对湿度条件下100小时)

(2) 测试样品

GRM21: 适用波峰 / 回流焊接的产品。

(3) 验收标准

使用60倍光学显微镜测量覆盖共晶锡的外部电极的表面积。

(4) 测试结果

参见表1。

表1

样品	初始状态	在常温下放置		在85°C高温条件下放置100小时	在40°C及90至95%的相对湿度条件下放置100小时
		6个月	12个月		
适用波峰 / 回流焊接的GRM21	95至100%	95至100%	95%	90至95%	95%

2. PCB焊接圆角高度的抗弯强度

(1) 测试方法

将片状电容器焊接在测试PCB上，锡膏的用量以达到圆角高度为准。

然后按照图示的方法弯曲PCB，再测量静电容量。

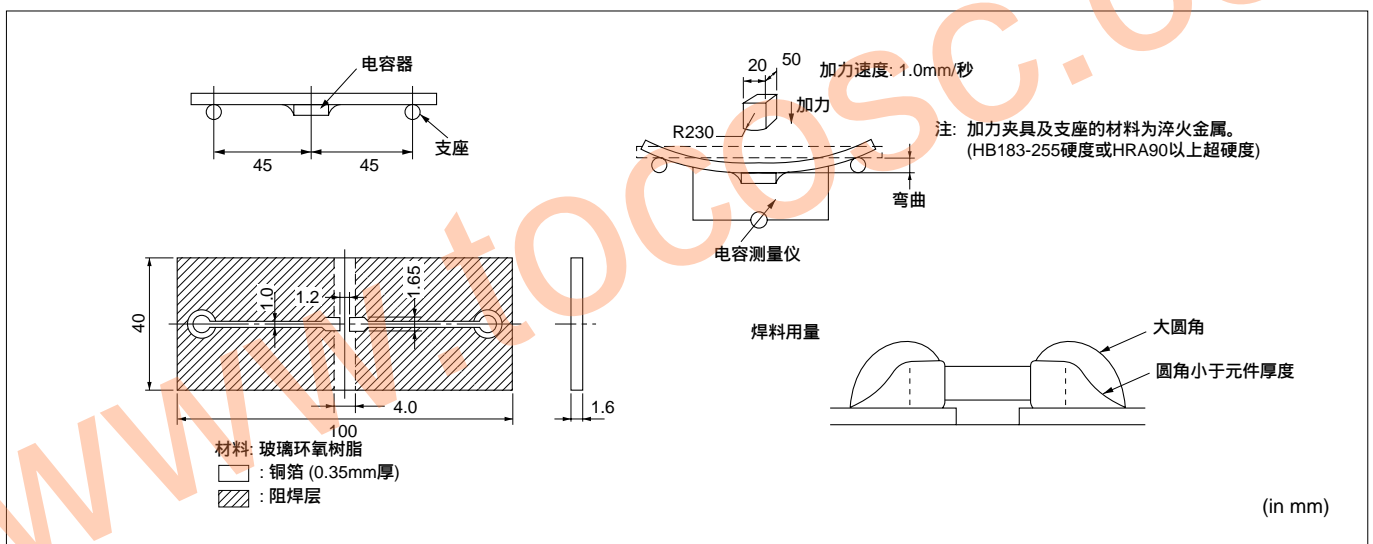

(2) 测试样品

GRM21: 5C/R7/F5特性 厚度 = 0.6mm

(3) 验收标准

产品若静电容量变化超过表2中规定的值则应被定为残次品。

表2

特性	静电容量变化
5C	在 ± 5% 或 ± 0.5pF (以较大者为准) 范围内
R7	在 ± 12.5% 范围内
F5	在 ± 20% 范围内

接下页。

接上页。

(4) 测试结果

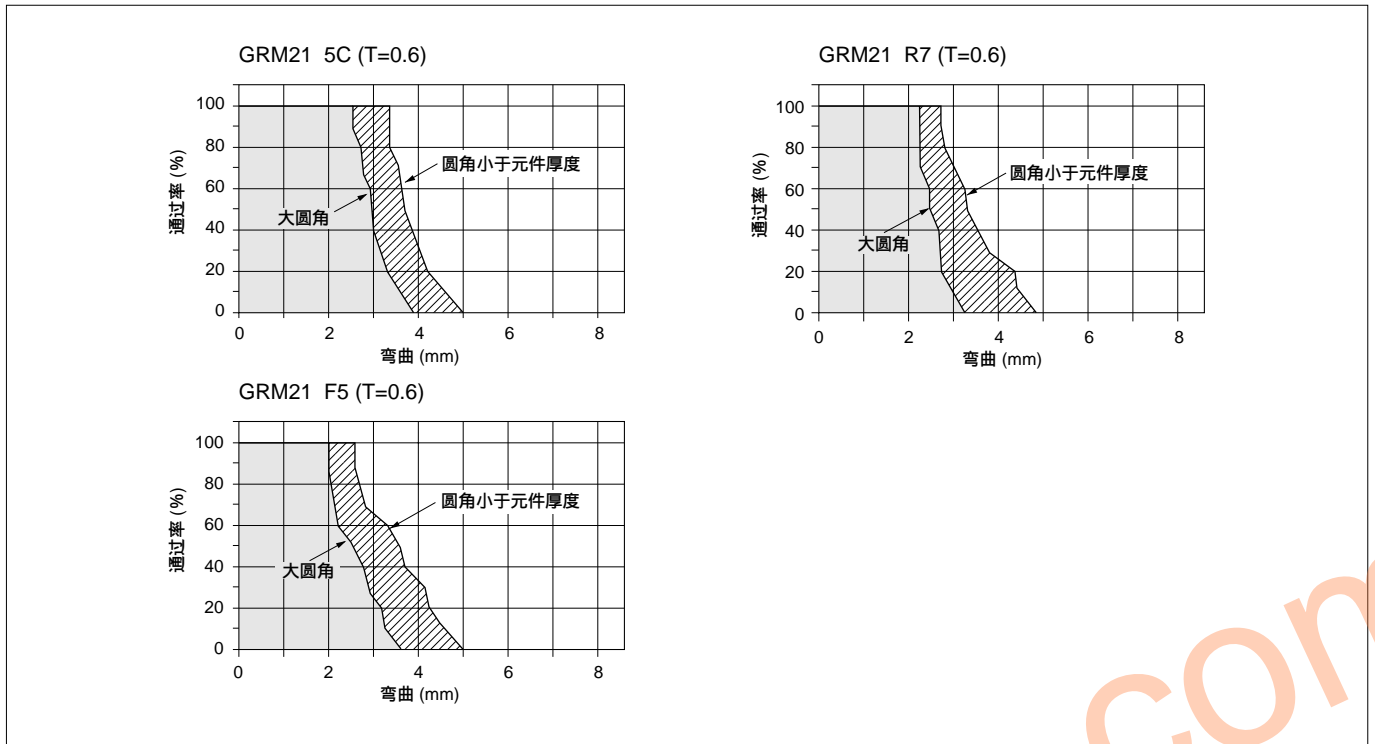

3. 焊接圆角高度的温度周期

(1) 测试方法

使用适量焊料将元件焊接在基片的各种测试夹具上，以达到所需圆角高度为准。然后使夹具经过如下所示的温度周期200次。

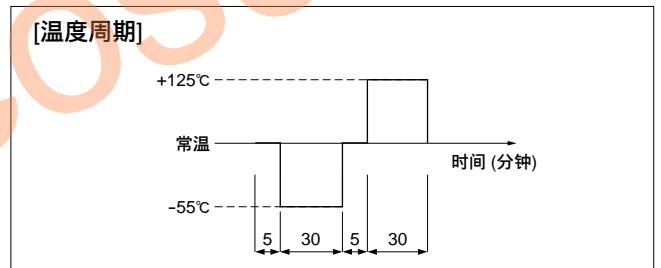

焊料用量

氧化铝基片一般用于回流焊接。

而玻璃环氧树脂或纸酚基片一般用于波峰焊接。

材料

氧化铝 (厚度: 0.64mm)

玻璃环氧树脂 (厚度: 1.64mm)

纸酚 (厚度: 1.64mm)

[焊料用量]

基片		氧化铝	玻璃环氧树脂或纸酚
焊料用量	①		
	②		
	③		
所用焊料		6×4共晶锡	

焊盘尺寸

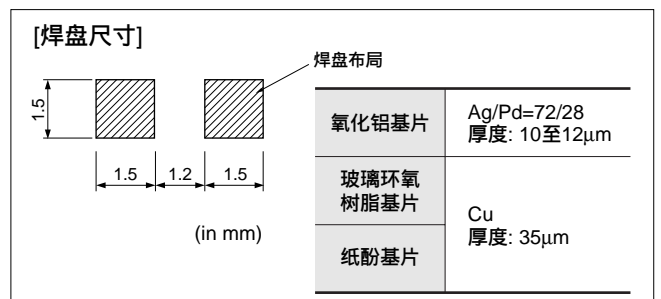

接下页。

参考资料

☐ 接上页。

(2) 测试样品

GRM21 5C/R7/F5特性 厚度 = 0.6mm

(3) 验收标准

产品若静电容量变化超过表3中规定的值则应被定为残次品。

Table 3

特性	静电容量变化
5C	在 $\pm 2.5\%$ 或 $\pm 0.25\text{pF}$ (以较大者为准) 范围内
R7	在 $\pm 7.5\%$ 范围内
F5	在 $\pm 20\%$ 范围内

(4) 测试结果

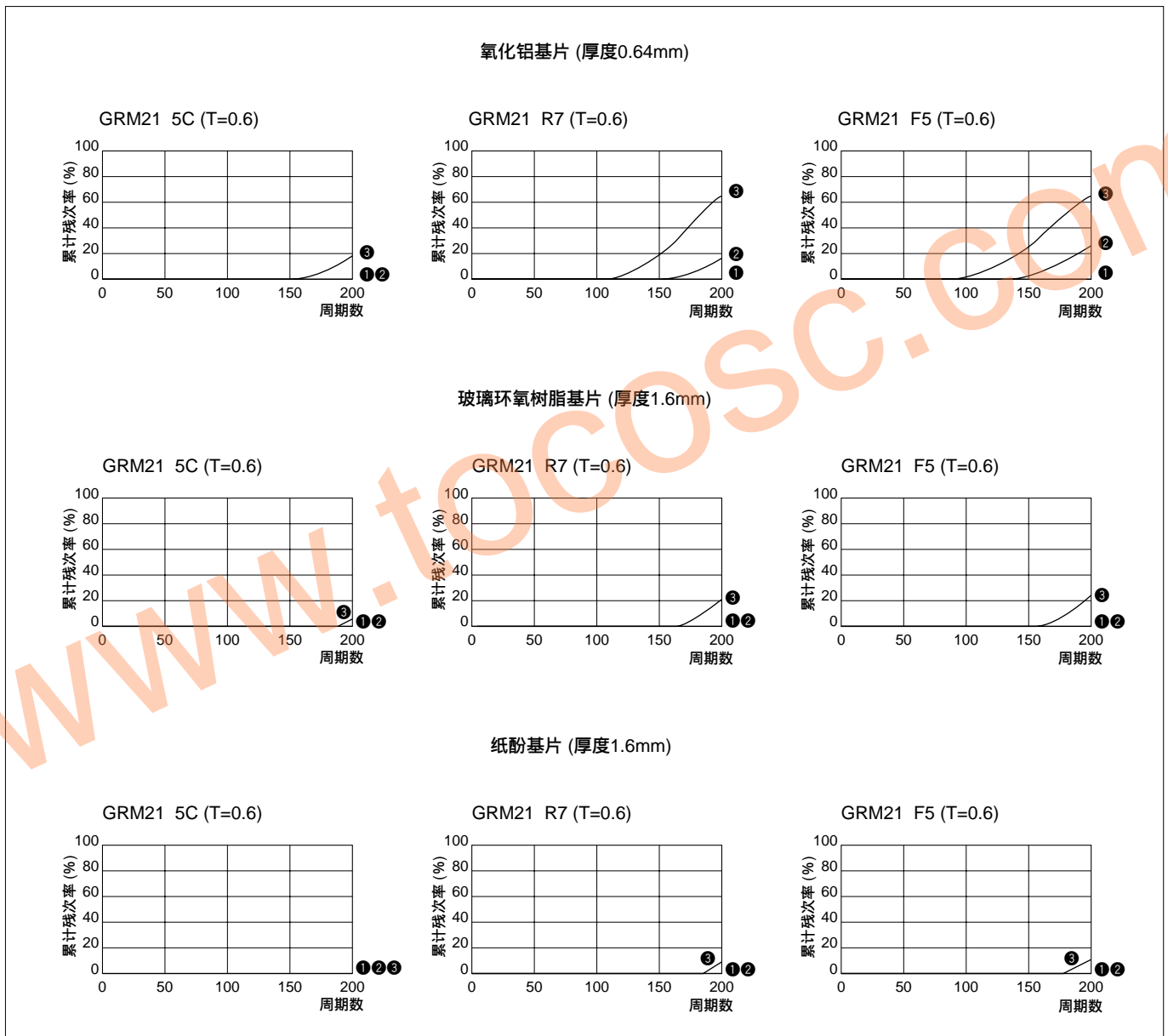

☐ 接下页。

☐ 接上页。

4. PCB材料的抗弯强度

(1) 测试方法

将元件焊接在测试板上。然后按照如下所示的方法弯曲测试版，再测量静电容量。

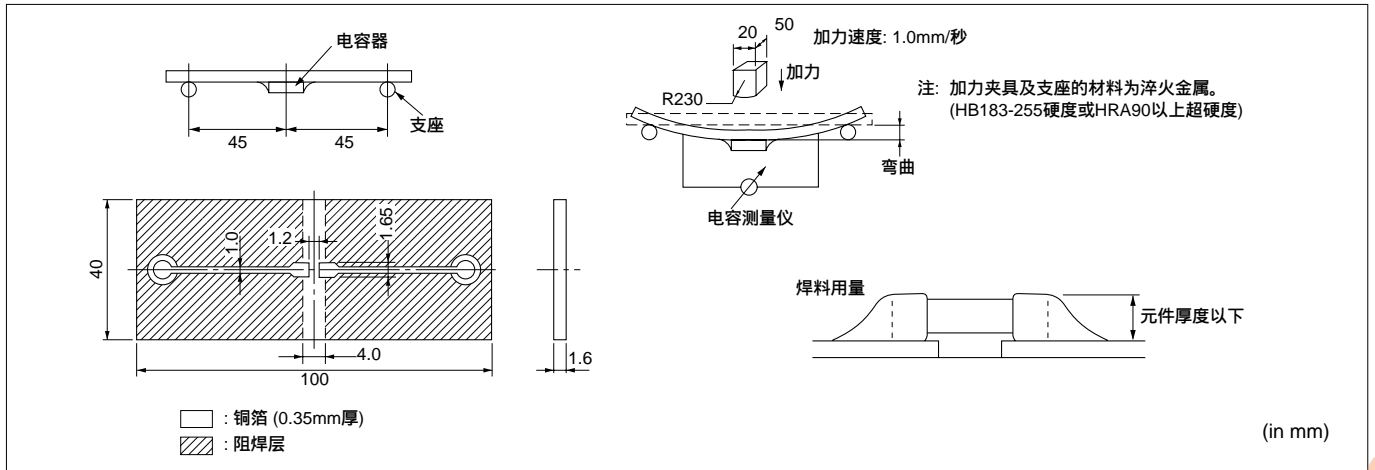

(2) 测试样品

GRM21 5C/R7/F5特性 标准厚度=0.6mm

(3) 验收标准

产品若静电容量变化超过表4中规定的值则应被定为残次品。

表4

特性	静电容量变化
5C	在 ± 5% 或 ± 0.5pF (以较大者为准) 范围内
R7	在 ± 12.5% 范围内
F5	在 ± 20% 范围内

(4) 测试结果

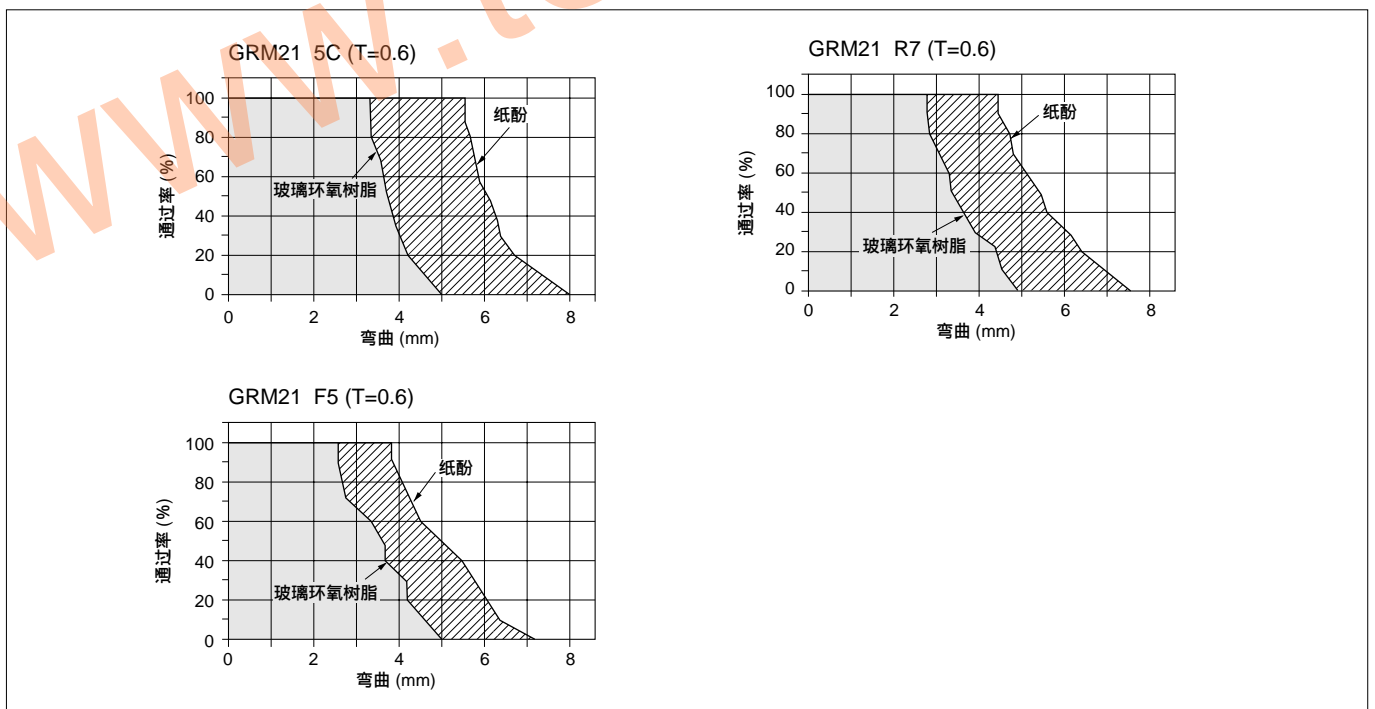

接下一页。 ☐

参考资料

☐ 接上页。

5. 断裂强度

(1) 测试方法

将元件放置于右图所示的钢板上。
 增大靠近测试样品中心位置处的负荷。

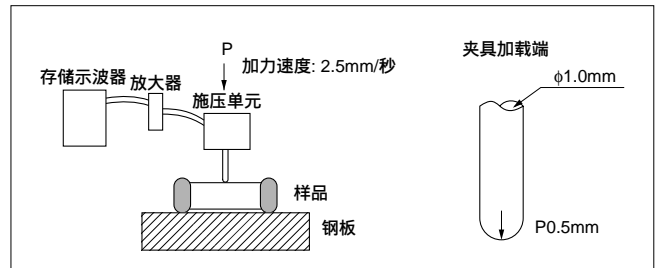

(2) 测试样品

GRM21 5C/R7/F5 特性
 GRM31 5C/R7/F5 特性

(3) 验收标准

导致元件断裂或开裂的负荷量可定义为弯曲力。

(4) 解释

断裂强度P与陶瓷元件厚度的平方成正比，可用二次曲线表示。

公式为：

$$P = \frac{2\gamma W T^2}{3L} \quad (\text{N})$$

W: 陶瓷元件宽度 (mm)
 T: 元件厚度 (mm)
 L: 支点之间的距离 (mm)
 γ : 弯曲应力 (N/mm²)

尺寸	L	W	γ		
			5C特性	R7特性	F5特性
GRM21	1.5	1.2	300	180	160
GRM31	2.7	1.5			

(in mm)

(5) 测试结果

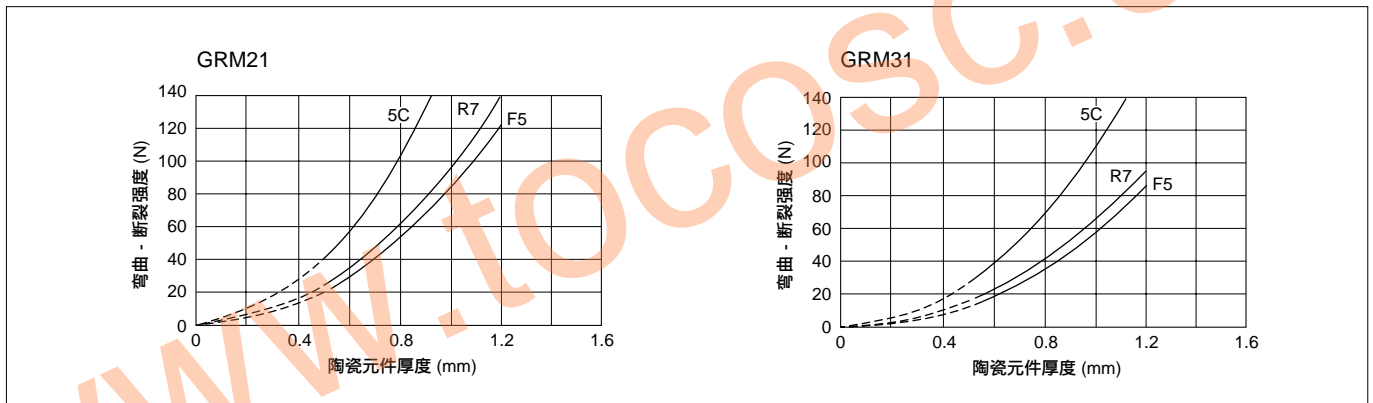

6. 热振荡

(1) 测试方法

在涂上助焊剂 (25%松香的乙醇溶液) 后，根据以下条件将元件浸泡在焊料槽 (6×4共晶锡) 内：

(2) 测试样品

GRM21 5C/R7/F5特性 标准厚度 = 0.6mm

(3) 验收标准

使用60倍光学显微镜目视检查测试样品。出现断裂或裂缝的产品应被定为残次品。

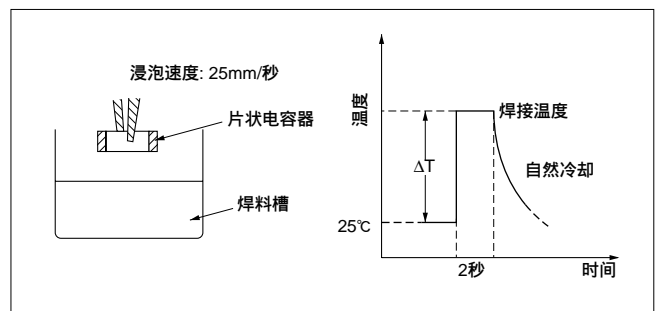

☐ 接下页。

☐ 接上页。

(4) 测试结果

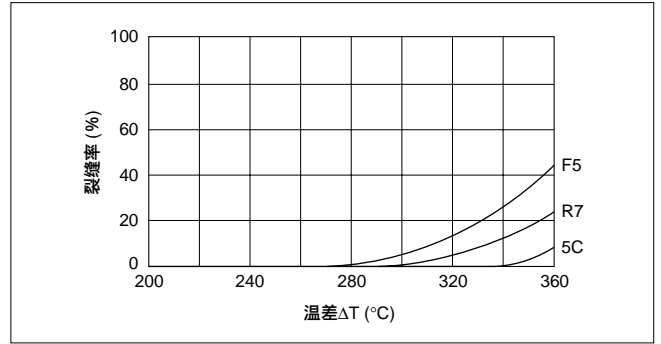

7. 耐焊热性

(1) 测试方法

回流焊接:

在氧化铝基片上涂上300μm锡膏。在回流焊接后，取出元件，检查外部电极上是否已出现沥滤现象。

波峰焊接

在用镊子将测试样品浸泡在波峰锡 (共晶锡) 中后，检查外部电极上是否已出现沥滤现象。

浸焊接

在用镊子将测试样品浸泡在静态锡 (共晶锡) 中后，检查外部电极上是否已出现沥滤现象。

所用助焊剂: 25%松香的乙醇溶液。

(2) 测试样品

GRM21: 波峰 / 回流焊接用 厚度 = 0.6mm

(3) 验收标准

沥滤的开始时间应定义为外部电极失去图示A-B-C-D面25%总长度时的时间。

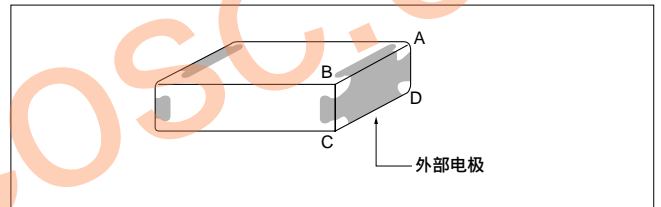

(4) 测试结果

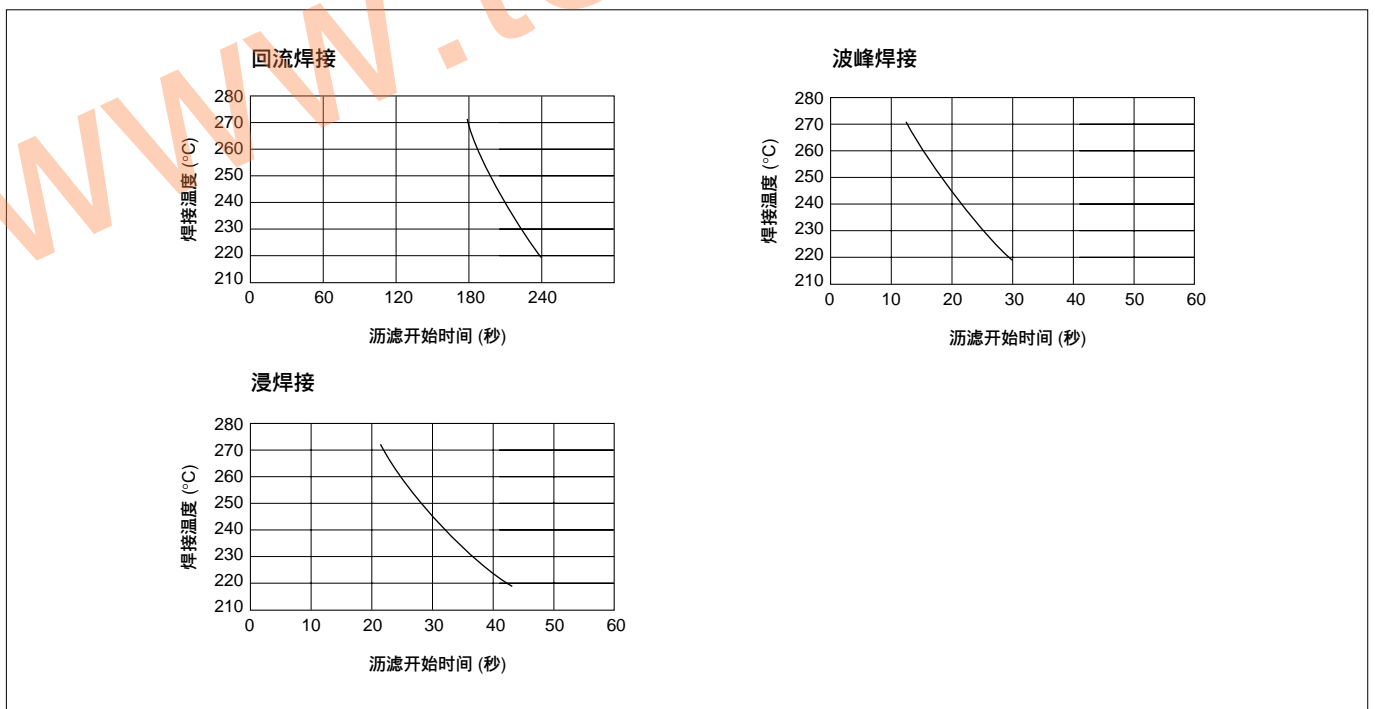

☐ 接下页。

参考资料

☐ 接上页。

8. 使用烙铁进行校正时的热振荡

(1) 测试方法

使用满足以下条件的烙铁和焊锡丝焊接已焊接在纸酚板上的焊缝处。(注: 烙铁头不应直接接触陶瓷电容器。)

(2) 测试样品

GRM21 5C/R7/F5特性 厚度 = 0.6mm

(3) 验收标准

使用60倍光学显微镜目视检查测试样品的外观。出现任何断裂或裂缝的样品应被定为残次品。

(4) 测试结果

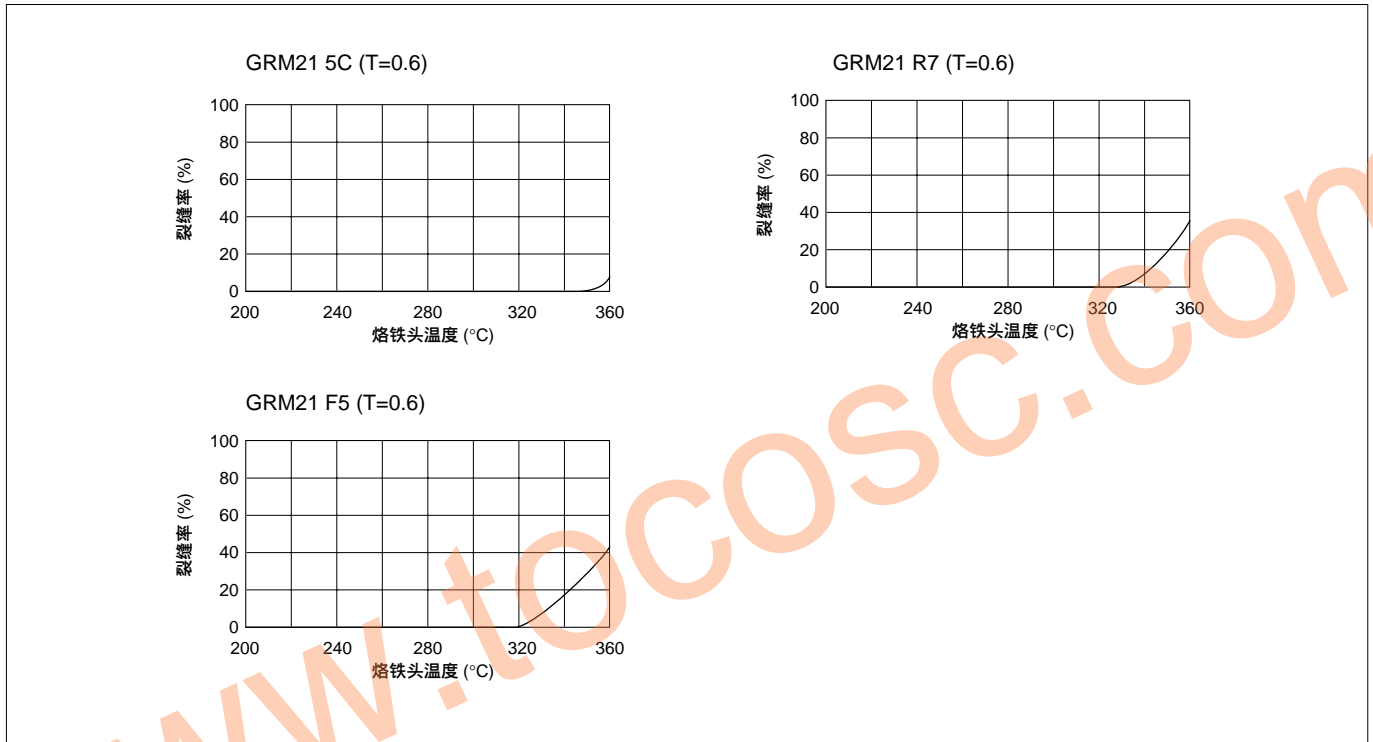
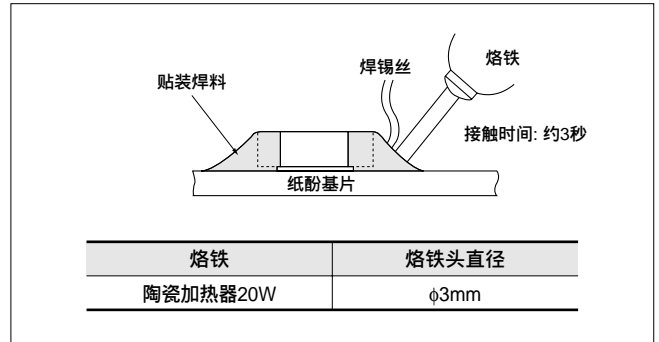

片状独石陶瓷电容器



中高压低失真型

特点

1. 损耗小，适合高频电路。
2. 村田的独创内部电极结构可承受高击穿电压。
3. 新型独石结构，可用于细小、表面贴装装置，能在高电压下工作。
4. 镀锡外部电极实现了良好的可焊性。
5. GRM21/31型适用波峰或回流焊接，而其它型号仅适用回流焊接。

用途

最适合高频脉冲电路使用，例如切换式电源、DC-DC转换器、镇流器（变频器荧光灯）等所用的缓冲电路。

请勿将这些产品用于汽车动力总成或安全设备，包括电动车和插入式混合动力车的充电器。

只有产品指南上明确标有“车用”的产品才可用于诸如动力传动和安全设备等汽车应用。

*: 若在脉冲电压中使用C0G特性DC630V产品，请确保不要在10kHz及以下脉冲或纹波电压条件下使用。

此类产品不适合应用于山野电源线电压应用例如交流滤波器。对于上述应用，请确保使用交流额定电压产品（GA2/GA3系列）。

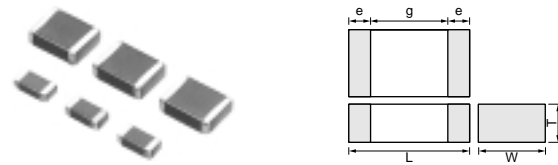

Part Number	Dimensions (mm)				
	L	W	T	e min.	g min.
GRM21A	2.0 ±0.2	1.25 ±0.2	1.0 +0, -0.3	0.3	0.7
GRM31A	3.2 ±0.2	1.6 ±0.2	1.25 +0, -0.3		1.5*
GRM31B			1.0 +0, -0.3		
GRM32A	3.2 ±0.2	2.5 ±0.2	1.25 +0, -0.3		
GRM32B			1.0 +0, -0.3		
GRM42A	4.5 ±0.3	2.0 ±0.2	1.0 +0, -0.3		

* GRM31A7U3D, GRM32A7U3D, GRM32B7U3D : 1.8mm min.

C0G 特性

品名	额定电压 (V)	温度特性代号 (规格)	静电容量 (pF)	长 L (mm)	宽 W (mm)	厚度 T (mm)	电极 g 最小 (mm)	电极 e (mm)
GRM31A5C2J101JW01D	DC630	C0G (EIA)	100 ±5%	3.2	1.6	1.0	1.5	0.3 min.
GRM31A5C2J121JW01D	DC630	C0G (EIA)	120 ±5%	3.2	1.6	1.0	1.5	0.3 min.
GRM31A5C2J151JW01D	DC630	C0G (EIA)	150 ±5%	3.2	1.6	1.0	1.5	0.3 min.
GRM31A5C2J181JW01D	DC630	C0G (EIA)	180 ±5%	3.2	1.6	1.0	1.5	0.3 min.
GRM31A5C2J221JW01D	DC630	C0G (EIA)	220 ±5%	3.2	1.6	1.0	1.5	0.3 min.
GRM31A5C2J271JW01D	DC630	C0G (EIA)	270 ±5%	3.2	1.6	1.0	1.5	0.3 min.
GRM31A5C2J331JW01D	DC630	C0G (EIA)	330 ±5%	3.2	1.6	1.0	1.5	0.3 min.
GRM31A5C2J391JW01D	DC630	C0G (EIA)	390 ±5%	3.2	1.6	1.0	1.5	0.3 min.
GRM31A5C2J471JW01D	DC630	C0G (EIA)	470 ±5%	3.2	1.6	1.0	1.5	0.3 min.
GRM31A5C2J561JW01D	DC630	C0G (EIA)	560 ±5%	3.2	1.6	1.0	1.5	0.3 min.
GRM31B5C2J681JW01L	DC630	C0G (EIA)	680 ±5%	3.2	1.6	1.25	1.5	0.3 min.
GRM31B5C2J821JW01L	DC630	C0G (EIA)	820 ±5%	3.2	1.6	1.25	1.5	0.3 min.
GRM31B5C2J102JW01L	DC630	C0G (EIA)	1000 ±5%	3.2	1.6	1.25	1.5	0.3 min.

U2J 特性

品名	额定电压 (V)	温度特性代号 (规格)	静电容量 (pF)	长 L (mm)	宽 W (mm)	厚度 T (mm)	电极 g 最小 (mm)	电极 e (mm)
GRM21A7U2E101JW31D	DC250	U2J (EIA)	100 ±5%	2.0	1.25	1.0	0.7	0.3 min.
GRM21A7U2E121JW31D	DC250	U2J (EIA)	120 ±5%	2.0	1.25	1.0	0.7	0.3 min.
GRM21A7U2E151JW31D	DC250	U2J (EIA)	150 ±5%	2.0	1.25	1.0	0.7	0.3 min.
GRM21A7U2E181JW31D	DC250	U2J (EIA)	180 ±5%	2.0	1.25	1.0	0.7	0.3 min.
GRM21A7U2E221JW31D	DC250	U2J (EIA)	220 ±5%	2.0	1.25	1.0	0.7	0.3 min.

接下页。

☐ 接上页。

品名	额定电压 (V)	温度特性代号 (规格)	静电容量 (pF)	长 L (mm)	宽 W (mm)	厚度 T (mm)	电极 g 最小 (mm)	电极 e (mm)
GRM21A7U2E271JW31D	DC250	U2J (EIA)	270 ±5%	2.0	1.25	1.0	0.7	0.3 min.
GRM21A7U2E331JW31D	DC250	U2J (EIA)	330 ±5%	2.0	1.25	1.0	0.7	0.3 min.
GRM21A7U2E391JW31D	DC250	U2J (EIA)	390 ±5%	2.0	1.25	1.0	0.7	0.3 min.
GRM21A7U2E471JW31D	DC250	U2J (EIA)	470 ±5%	2.0	1.25	1.0	0.7	0.3 min.
GRM21A7U2E561JW31D	DC250	U2J (EIA)	560 ±5%	2.0	1.25	1.0	0.7	0.3 min.
GRM21A7U2E681JW31D	DC250	U2J (EIA)	680 ±5%	2.0	1.25	1.0	0.7	0.3 min.
GRM21A7U2E821JW31D	DC250	U2J (EIA)	820 ±5%	2.0	1.25	1.0	0.7	0.3 min.
GRM21A7U2E102JW31D	DC250	U2J (EIA)	1000 ±5%	2.0	1.25	1.0	0.7	0.3 min.
GRM21A7U2E122JW31D	DC250	U2J (EIA)	1200 ±5%	2.0	1.25	1.0	0.7	0.3 min.
GRM21A7U2E152JW31D	DC250	U2J (EIA)	1500 ±5%	2.0	1.25	1.0	0.7	0.3 min.
GRM21A7U2E182JW31D	DC250	U2J (EIA)	1800 ±5%	2.0	1.25	1.0	0.7	0.3 min.
GRM21A7U2E222JW31D	DC250	U2J (EIA)	2200 ±5%	2.0	1.25	1.0	0.7	0.3 min.
GRM31A7U2E272JW31D	DC250	U2J (EIA)	2700 ±5%	3.2	1.6	1.0	1.5	0.3 min.
GRM31A7U2E332JW31D	DC250	U2J (EIA)	3300 ±5%	3.2	1.6	1.0	1.5	0.3 min.
GRM31A7U2E392JW31D	DC250	U2J (EIA)	3900 ±5%	3.2	1.6	1.0	1.5	0.3 min.
GRM31A7U2E472JW31D	DC250	U2J (EIA)	4700 ±5%	3.2	1.6	1.0	1.5	0.3 min.
GRM31A7U2E562JW31D	DC250	U2J (EIA)	5600 ±5%	3.2	1.6	1.0	1.5	0.3 min.
GRM31B7U2E682JW31L	DC250	U2J (EIA)	6800 ±5%	3.2	1.6	1.25	1.5	0.3 min.
GRM31B7U2E822JW31L	DC250	U2J (EIA)	8200 ±5%	3.2	1.6	1.25	1.5	0.3 min.
GRM31B7U2E103JW31L	DC250	U2J (EIA)	10000 ±5%	3.2	1.6	1.25	1.5	0.3 min.
GRM31A7U2J100JW31D	DC630	U2J (EIA)	10 ±5%	3.2	1.6	1.0	1.5	0.3 min.
GRM31A7U2J120JW31D	DC630	U2J (EIA)	12 ±5%	3.2	1.6	1.0	1.5	0.3 min.
GRM31A7U2J150JW31D	DC630	U2J (EIA)	15 ±5%	3.2	1.6	1.0	1.5	0.3 min.
GRM31A7U2J180JW31D	DC630	U2J (EIA)	18 ±5%	3.2	1.6	1.0	1.5	0.3 min.
GRM31A7U2J220JW31D	DC630	U2J (EIA)	22 ±5%	3.2	1.6	1.0	1.5	0.3 min.
GRM31A7U2J270JW31D	DC630	U2J (EIA)	27 ±5%	3.2	1.6	1.0	1.5	0.3 min.
GRM31A7U2J330JW31D	DC630	U2J (EIA)	33 ±5%	3.2	1.6	1.0	1.5	0.3 min.
GRM31A7U2J390JW31D	DC630	U2J (EIA)	39 ±5%	3.2	1.6	1.0	1.5	0.3 min.
GRM31A7U2J470JW31D	DC630	U2J (EIA)	47 ±5%	3.2	1.6	1.0	1.5	0.3 min.
GRM31A7U2J560JW31D	DC630	U2J (EIA)	56 ±5%	3.2	1.6	1.0	1.5	0.3 min.
GRM31A7U2J680JW31D	DC630	U2J (EIA)	68 ±5%	3.2	1.6	1.0	1.5	0.3 min.
GRM31A7U2J820JW31D	DC630	U2J (EIA)	82 ±5%	3.2	1.6	1.0	1.5	0.3 min.
GRM31A7U2J101JW31D	DC630	U2J (EIA)	100 ±5%	3.2	1.6	1.0	1.5	0.3 min.
GRM31A7U2J121JW31D	DC630	U2J (EIA)	120 ±5%	3.2	1.6	1.0	1.5	0.3 min.
GRM31A7U2J151JW31D	DC630	U2J (EIA)	150 ±5%	3.2	1.6	1.0	1.5	0.3 min.
GRM31A7U2J181JW31D	DC630	U2J (EIA)	180 ±5%	3.2	1.6	1.0	1.5	0.3 min.
GRM31A7U2J221JW31D	DC630	U2J (EIA)	220 ±5%	3.2	1.6	1.0	1.5	0.3 min.
GRM31A7U2J271JW31D	DC630	U2J (EIA)	270 ±5%	3.2	1.6	1.0	1.5	0.3 min.
GRM31A7U2J331JW31D	DC630	U2J (EIA)	330 ±5%	3.2	1.6	1.0	1.5	0.3 min.
GRM31A7U2J391JW31D	DC630	U2J (EIA)	390 ±5%	3.2	1.6	1.0	1.5	0.3 min.
GRM31A7U2J471JW31D	DC630	U2J (EIA)	470 ±5%	3.2	1.6	1.0	1.5	0.3 min.
GRM31A7U2J561JW31D	DC630	U2J (EIA)	560 ±5%	3.2	1.6	1.0	1.5	0.3 min.
GRM31A7U2J681JW31D	DC630	U2J (EIA)	680 ±5%	3.2	1.6	1.0	1.5	0.3 min.
GRM31A7U2J821JW31D	DC630	U2J (EIA)	820 ±5%	3.2	1.6	1.0	1.5	0.3 min.
GRM31A7U2J102JW31D	DC630	U2J (EIA)	1000 ±5%	3.2	1.6	1.0	1.5	0.3 min.
GRM32A7U2J122JW31D	DC630	U2J (EIA)	1200 ±5%	3.2	2.5	1.0	1.5	0.3 min.
GRM32A7U2J152JW31D	DC630	U2J (EIA)	1500 ±5%	3.2	2.5	1.0	1.5	0.3 min.
GRM32A7U2J182JW31D	DC630	U2J (EIA)	1800 ±5%	3.2	2.5	1.0	1.5	0.3 min.
GRM32A7U2J222JW31D	DC630	U2J (EIA)	2200 ±5%	3.2	2.5	1.0	1.5	0.3 min.
GRM31A7U3A100JW31D	DC1000	U2J (EIA)	10 ±5%	3.2	1.6	1.0	1.5	0.3 min.
GRM31A7U3A120JW31D	DC1000	U2J (EIA)	12 ±5%	3.2	1.6	1.0	1.5	0.3 min.
GRM31A7U3A150JW31D	DC1000	U2J (EIA)	15 ±5%	3.2	1.6	1.0	1.5	0.3 min.
GRM31A7U3A180JW31D	DC1000	U2J (EIA)	18 ±5%	3.2	1.6	1.0	1.5	0.3 min.
GRM31A7U3A220JW31D	DC1000	U2J (EIA)	22 ±5%	3.2	1.6	1.0	1.5	0.3 min.
GRM31A7U3A270JW31D	DC1000	U2J (EIA)	27 ±5%	3.2	1.6	1.0	1.5	0.3 min.
GRM31A7U3A330JW31D	DC1000	U2J (EIA)	33 ±5%	3.2	1.6	1.0	1.5	0.3 min.
GRM31A7U3A390JW31D	DC1000	U2J (EIA)	39 ±5%	3.2	1.6	1.0	1.5	0.3 min.

接下页。☐

☞ 接上页。

品名	额定电压 (V)	温度特性代号 (规格)	静电容量 (pF)	长 L (mm)	宽 W (mm)	厚度 T (mm)	电极 g 最小 (mm)	电极 e (mm)
GRM31A7U3A470JW31D	DC1000	U2J (EIA)	47 ±5%	3.2	1.6	1.0	1.5	0.3 min.
GRM31A7U3A560JW31D	DC1000	U2J (EIA)	56 ±5%	3.2	1.6	1.0	1.5	0.3 min.
GRM31A7U3A680JW31D	DC1000	U2J (EIA)	68 ±5%	3.2	1.6	1.0	1.5	0.3 min.
GRM31A7U3A820JW31D	DC1000	U2J (EIA)	82 ±5%	3.2	1.6	1.0	1.5	0.3 min.
GRM31A7U3A101JW31D	DC1000	U2J (EIA)	100 ±5%	3.2	1.6	1.0	1.5	0.3 min.
GRM31A7U3A121JW31D	DC1000	U2J (EIA)	120 ±5%	3.2	1.6	1.0	1.5	0.3 min.
GRM31A7U3A151JW31D	DC1000	U2J (EIA)	150 ±5%	3.2	1.6	1.0	1.5	0.3 min.
GRM31A7U3A181JW31D	DC1000	U2J (EIA)	180 ±5%	3.2	1.6	1.0	1.5	0.3 min.
GRM31A7U3A221JW31D	DC1000	U2J (EIA)	220 ±5%	3.2	1.6	1.0	1.5	0.3 min.
GRM31A7U3A271JW31D	DC1000	U2J (EIA)	270 ±5%	3.2	1.6	1.0	1.5	0.3 min.
GRM31A7U3A331JW31D	DC1000	U2J (EIA)	330 ±5%	3.2	1.6	1.0	1.5	0.3 min.
GRM31B7U3A391JW31L	DC1000	U2J (EIA)	390 ±5%	3.2	1.6	1.25	1.5	0.3 min.
GRM31B7U3A471JW31L	DC1000	U2J (EIA)	470 ±5%	3.2	1.6	1.25	1.5	0.3 min.
GRM31A7U3D100JW31D	DC2000	U2J (EIA)	10 ±5%	3.2	1.6	1.0	1.8	0.3 min.
GRM31A7U3D120JW31D	DC2000	U2J (EIA)	12 ±5%	3.2	1.6	1.0	1.8	0.3 min.
GRM31A7U3D150JW31D	DC2000	U2J (EIA)	15 ±5%	3.2	1.6	1.0	1.8	0.3 min.
GRM31A7U3D180JW31D	DC2000	U2J (EIA)	18 ±5%	3.2	1.6	1.0	1.8	0.3 min.
GRM31A7U3D220JW31D	DC2000	U2J (EIA)	22 ±5%	3.2	1.6	1.0	1.8	0.3 min.
GRM31A7U3D270JW31D	DC2000	U2J (EIA)	27 ±5%	3.2	1.6	1.0	1.8	0.3 min.
GRM31A7U3D330JW31D	DC2000	U2J (EIA)	33 ±5%	3.2	1.6	1.0	1.8	0.3 min.
GRM31A7U3D390JW31D	DC2000	U2J (EIA)	39 ±5%	3.2	1.6	1.0	1.8	0.3 min.
GRM31A7U3D470JW31D	DC2000	U2J (EIA)	47 ±5%	3.2	1.6	1.0	1.8	0.3 min.
GRM31A7U3D560JW31D	DC2000	U2J (EIA)	56 ±5%	3.2	1.6	1.0	1.8	0.3 min.
GRM31A7U3D680JW31D	DC2000	U2J (EIA)	68 ±5%	3.2	1.6	1.0	1.8	0.3 min.
GRM32A7U3D820JW31D	DC2000	U2J (EIA)	82 ±5%	3.2	2.5	1.0	1.8	0.3 min.
GRM32A7U3D101JW31D	DC2000	U2J (EIA)	100 ±5%	3.2	2.5	1.0	1.8	0.3 min.
GRM32A7U3D121JW31D	DC2000	U2J (EIA)	120 ±5%	3.2	2.5	1.0	1.8	0.3 min.
GRM32A7U3D151JW31D	DC2000	U2J (EIA)	150 ±5%	3.2	2.5	1.0	1.8	0.3 min.
GRM32B7U3D181JW31L	DC2000	U2J (EIA)	180 ±5%	3.2	2.5	1.25	1.8	0.3 min.
GRM32B7U3D221JW31L	DC2000	U2J (EIA)	220 ±5%	3.2	2.5	1.25	1.8	0.3 min.
GRM42A7U3F270JW31L	DC3150	U2J (EIA)	27 ±5%	4.5	2.0	1.0	2.9	0.3 min.
GRM42A7U3F330JW31L	DC3150	U2J (EIA)	33 ±5%	4.5	2.0	1.0	2.9	0.3 min.
GRM42A7U3F390JW31L	DC3150	U2J (EIA)	39 ±5%	4.5	2.0	1.0	2.9	0.3 min.
GRM42A7U3F470JW31L	DC3150	U2J (EIA)	47 ±5%	4.5	2.0	1.0	2.9	0.3 min.
GRM42A7U3F560JW31L	DC3150	U2J (EIA)	56 ±5%	4.5	2.0	1.0	2.9	0.3 min.
GRM42A7U3F680JW31L	DC3150	U2J (EIA)	68 ±5%	4.5	2.0	1.0	2.9	0.3 min.
GRM42A7U3F820JW31L	DC3150	U2J (EIA)	82 ±5%	4.5	2.0	1.0	2.9	0.3 min.
GRM42A7U3F101JW31L	DC3150	U2J (EIA)	100 ±5%	4.5	2.0	1.0	2.9	0.3 min.

规格和测试方法

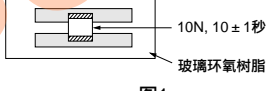
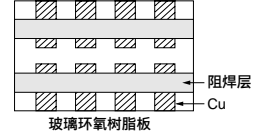
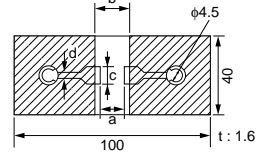
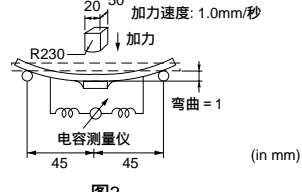
编号	项目	特性	测试方法																															
1	动作温度范围	- 55至 + 125°C	-																															
2	外观	无缺陷或异常	目视检查																															
3	尺寸	在规定尺寸范围内	使用游标卡尺																															
4	介电强度	无缺陷或异常	在端子间施加表中的电压1至5秒时不应观察到任何故障，并且充电/放电电流低于50mA。 <table border="1"> <thead> <tr> <th>额定电压</th> <th>测试电压</th> </tr> </thead> <tbody> <tr> <td>DC250V</td> <td>200%额定电压</td> </tr> <tr> <td>DC630V</td> <td>150%额定电压</td> </tr> <tr> <td>DC1kV, DC2kV</td> <td>120%额定电压</td> </tr> <tr> <td>DC3.15kV</td> <td>DC4095V</td> </tr> </tbody> </table>	额定电压	测试电压	DC250V	200%额定电压	DC630V	150%额定电压	DC1kV, DC2kV	120%额定电压	DC3.15kV	DC4095V																					
额定电压	测试电压																																	
DC250V	200%额定电压																																	
DC630V	150%额定电压																																	
DC1kV, DC2kV	120%额定电压																																	
DC3.15kV	DC4095V																																	
5	绝缘电阻 (I.R.)	大于10,000MΩ	绝缘电阻应在DC500 ± 50V(额定电压DC250V时DC250 ± 25V)条件下、在充电开始60 ± 5秒内测量。																															
6	静电容量	在规定偏差范围内	静电容量/Q值应在以下频率及电压条件下测量。 <table border="1"> <thead> <tr> <th>静电容量</th> <th>频率</th> <th>电压</th> </tr> </thead> <tbody> <tr> <td>C < 1,000pF</td> <td>1 ± 0.2MHz</td> <td>AC0.5至5V (r.m.s)</td> </tr> <tr> <td>C ≥ 1,000pF</td> <td>1 ± 0.2kHz</td> <td>AC1 ± 0.2V (r.m.s)</td> </tr> </tbody> </table>	静电容量	频率	电压	C < 1,000pF	1 ± 0.2MHz	AC0.5至5V (r.m.s)	C ≥ 1,000pF	1 ± 0.2kHz	AC1 ± 0.2V (r.m.s)																						
静电容量	频率	电压																																
C < 1,000pF	1 ± 0.2MHz	AC0.5至5V (r.m.s)																																
C ≥ 1,000pF	1 ± 0.2kHz	AC1 ± 0.2V (r.m.s)																																
7	Q	最小1,000	静电容量应在表中列出的各温度阶段进行测量。 <table border="1"> <thead> <tr> <th>阶段</th> <th>温度 (°C)</th> </tr> </thead> <tbody> <tr> <td>1</td> <td>25 ± 2</td> </tr> <tr> <td>2</td> <td>最低动作温度 ± 3</td> </tr> <tr> <td>3</td> <td>25 ± 2</td> </tr> <tr> <td>4</td> <td>最高动作温度 ± 2</td> </tr> <tr> <td>5</td> <td>25 ± 2</td> </tr> </tbody> </table>	阶段	温度 (°C)	1	25 ± 2	2	最低动作温度 ± 3	3	25 ± 2	4	最高动作温度 ± 2	5	25 ± 2																			
阶段	温度 (°C)																																	
1	25 ± 2																																	
2	最低动作温度 ± 3																																	
3	25 ± 2																																	
4	最高动作温度 ± 2																																	
5	25 ± 2																																	
8	静电容量温度特性	温度系数 C0G特性: 0 ± 30ppm/°C (温度范围: + 25至 + 125°C) 0 + 30, - 72ppm/°C (温度范围: - 55至 + 25°C) U2J特性: - 750 ± 120ppm/°C (温度范围: + 25至 + 125°C) - 750 + 120, - 347ppm/°C (温度范围: - 55至 + 25°C)	静电容量应在表中列出的各温度阶段进行测量。																															
9	端子结合强度	不应出现端子脱落或其它缺陷。	将电容器焊接在图1中所示的测试夹具(玻璃环氧树脂板)上。然后沿箭头方向施加10N的力。焊接应使用回流焊接方法进行，而且应谨慎作业，以使焊接均匀且不会由于热冲击产生缺陷。  图1																															
10	外观	无缺陷或异常	将电容器焊接在测试夹具(玻璃环氧树脂板)上。电容器应进行简谐运动，其总幅值为1.5mm，频率在近似10至55Hz之间均匀变化。频率范围(从10至55Hz再返回10Hz)应在约1分钟内完成。振动应在3个相互垂直方向各进行2小时(总计6小时)。  图2																															
	静电容量	在规定偏差范围内																																
	Q	最小1,000																																
11	弯曲强度	不应出现裂缝或明显缺陷。  <table border="1"> <thead> <tr> <th rowspan="2">长 × 宽 (mm)</th> <th colspan="4">尺寸 (mm)</th> <th rowspan="2">d</th> </tr> <tr> <th>a</th> <th>b</th> <th>c</th> <th></th> </tr> </thead> <tbody> <tr> <td>2.0 × 1.25</td> <td>1.2</td> <td>4.0</td> <td>1.65</td> <td></td> <td rowspan="4">1.0</td> </tr> <tr> <td>3.2 × 1.6</td> <td>2.2</td> <td>5.0</td> <td>2.0</td> <td></td> </tr> <tr> <td>3.2 × 2.5</td> <td>2.2</td> <td>5.0</td> <td>2.9</td> <td></td> </tr> <tr> <td>4.5 × 2.0</td> <td>3.5</td> <td>7.0</td> <td>2.4</td> <td></td> </tr> </tbody> </table> 图2	长 × 宽 (mm)	尺寸 (mm)				d	a	b	c		2.0 × 1.25	1.2	4.0	1.65		1.0	3.2 × 1.6	2.2	5.0	2.0		3.2 × 2.5	2.2	5.0	2.9		4.5 × 2.0	3.5	7.0	2.4		将电容器焊接在图2中所示的测试夹具(玻璃环氧树脂板)上。然后在图3所示的方向加力。焊接应使用回流焊接方法进行，而且应谨慎作业，以使焊接均匀且不会由于热冲击产生缺陷。  图3
长 × 宽 (mm)	尺寸 (mm)				d																													
	a	b	c																															
2.0 × 1.25	1.2	4.0	1.65		1.0																													
3.2 × 1.6	2.2	5.0	2.0																															
3.2 × 2.5	2.2	5.0	2.9																															
4.5 × 2.0	3.5	7.0	2.4																															
12	端子可焊性	75%端子需均匀且连续焊接。	将电容器浸在乙醇 (JIS-K-8101) 和松香 (JIS-K-5902) (松香占25%的重量) 溶液中。浸泡在焊锡溶液2 ± 0.5秒。 浸泡速度: 25 ± 2.5mm/秒 焊锡温度: 245 ± 5°C 无铅焊料 (Sn-3.0Ag-0.5Cu) 235 ± 5°C H60A或H63A 共晶锡																															

接下页。 

规格和测试方法

☐ 接上页。

编号	项目	特性	测试方法															
13	耐焊热性	外观	无明显缺陷															
		静电容量变化	在 ± 2.5% 范围内															
		Q	最小1,000															
		绝缘电阻	大于10,000MΩ															
		介电强度	按照第4项															
			在120至150°C* 范围内预热电容器1分钟。 将电容器浸泡在260 ± 5°C的共晶锡溶液10 ± 1秒。 撤到*室内条件下放置24 ± 2小时，然后进行测量。 浸泡速度: 25 ± 2.5mm/秒 *预热3.2 × 2.5mm以上 <table border="1"> <thead> <tr> <th>阶段</th> <th>温度</th> <th>时间</th> </tr> </thead> <tbody> <tr> <td>1</td> <td>100 至120°C</td> <td>1分钟</td> </tr> <tr> <td>2</td> <td>170 至200°C</td> <td>1分钟</td> </tr> </tbody> </table>	阶段	温度	时间	1	100 至120°C	1分钟	2	170 至200°C	1分钟						
阶段	温度	时间																
1	100 至120°C	1分钟																
2	170 至200°C	1分钟																
14	温度周期	外观	无明显缺陷															
		静电容量变化	在 ± 2.5% 范围内															
		Q	最小500															
		绝缘电阻	大于10,000MΩ															
		介电强度	按照第4项															
			将电容器焊接在图4中所示的支撑夹具(玻璃环氧树脂板)上。 按照下表中列出的4种热处理方法执行5个周期。 在*室内条件下放置24 ± 2小时，然后进行测量。 <table border="1"> <thead> <tr> <th>阶段</th> <th>温度(°C)</th> <th>时间(分钟)</th> </tr> </thead> <tbody> <tr> <td>1</td> <td>最低动作温度 ± 3</td> <td>30 ± 3</td> </tr> <tr> <td>2</td> <td>常温</td> <td>2至3</td> </tr> <tr> <td>3</td> <td>最高动作温度 ± 2</td> <td>30 ± 3</td> </tr> <tr> <td>4</td> <td>常温</td> <td>2至3</td> </tr> </tbody> </table>  <p style="text-align: center;">图4</p>	阶段	温度(°C)	时间(分钟)	1	最低动作温度 ± 3	30 ± 3	2	常温	2至3	3	最高动作温度 ± 2	30 ± 3	4	常温	2至3
阶段	温度(°C)	时间(分钟)																
1	最低动作温度 ± 3	30 ± 3																
2	常温	2至3																
3	最高动作温度 ± 2	30 ± 3																
4	常温	2至3																
15	湿度(稳态)	外观	无明显缺陷															
		静电容量变化	在 ± 5.0% 范围内															
		Q	最小350															
		绝缘电阻	大于1,000MΩ															
		介电强度	按照第4项															
			将电容器在40 ± 2°C及90至95%相对湿度条件下放置500 + 24/- 0小时。 撤到*室内条件下放置24 ± 2小时，然后进行测量。															
16	寿命	外观	无明显缺陷															
		静电容量变化	在 ± 3.0% 范围内															
		Q	最小350															
		绝缘电阻	大于1,000MΩ															
		介电强度	按照第4项															
			在最高工作温度 ± 3°C条件下，施加表中的电压1000 + 48/- 0小时。 撤到常温条件*下放置24 ± 2小时，然后进行测量。 <table border="1"> <thead> <tr> <th>额定电压</th> <th>施加电压</th> </tr> </thead> <tbody> <tr> <td>DC250V</td> <td>150%额定电压</td> </tr> <tr> <td>DC630V, DC1kV, DC2kV, DC3.15kV</td> <td>120%额定电压</td> </tr> </tbody> </table> 充电/放电电流低于50mA。	额定电压	施加电压	DC250V	150%额定电压	DC630V, DC1kV, DC2kV, DC3.15kV	120%额定电压									
额定电压	施加电压																	
DC250V	150%额定电压																	
DC630V, DC1kV, DC2kV, DC3.15kV	120%额定电压																	

* "室内条件" 温度: 15至35°C, 相对湿度: 45至75%, 大气压: 86至106kPa

片状独石陶瓷电容器



中高压大容量一般用

特点

1. 新型独石结构，体积小、静电容量高，能在高电压下工作。
2. 镀锡外部电极实现了良好的可焊性。
3. GRM18/21/31型适用波峰或回流焊接，而其它型号仅适用回流焊接。

用途

1. 最适合用于切换式电源的二极管缓冲电路上。
2. 最适合用作DC-DC转换器的一次 - 二次耦合。
3. 最适合用于电话、传真机及调制解调器的线路滤波器及振铃检测器。

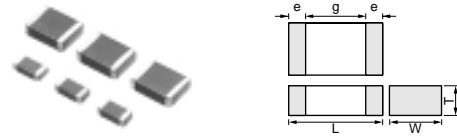

Part Number	Dimensions (mm)				
	L	W	T	e	g min.
GRM188	1.6 ±0.1	0.8 ±0.1	0.8 ±0.1	0.2 to 0.5	0.4
GRM21A	2.0 ±0.2	1.25 ±0.2	1.0 +0,-0.3		
GRM21B			1.25 ±0.2		
GRM31B	3.2 ±0.2	1.6 ±0.2	1.25 +0,-0.3	0.3 min.	1.2
GRM31C			1.6 ±0.2		
GRM32Q	3.2 ±0.3	2.5 ±0.2	1.5 +0,-0.3		
GRM32D			2.0 +0,-0.3		
GRM43Q	4.5 ±0.4	3.2 ±0.3	1.5 +0,-0.3		
GRM43D			2.0 +0,-0.3		
GRM55D	5.7 ±0.4	5.0 ±0.4	2.0 +0,-0.3	3.2	

请勿将这些产品用于汽车动力总成或安全设备，包括电动车和插入式混合动力车的充电器。

只有产品指南上明确标有“车用”的产品才可用于诸如动力传动和安全设备等汽车应用。

品名	额定电压 (V)	温度特性代号 (规格)	静电容量	长 L (mm)	宽 W (mm)	厚度 T (mm)	电极 g 最小 (mm)	电极 e (mm)
GRM188R72E221KW07D	DC250	X7R (EIA)	220pF ±10%	1.6	0.8	0.8	0.4	0.2 to 0.5
GRM188R72E331KW07D	DC250	X7R (EIA)	330pF ±10%	1.6	0.8	0.8	0.4	0.2 to 0.5
GRM188R72E471KW07D	DC250	X7R (EIA)	470pF ±10%	1.6	0.8	0.8	0.4	0.2 to 0.5
GRM188R72E681KW07D	DC250	X7R (EIA)	680pF ±10%	1.6	0.8	0.8	0.4	0.2 to 0.5
GRM188R72E102KW07D	DC250	X7R (EIA)	1000pF ±10%	1.6	0.8	0.8	0.4	0.2 to 0.5
GRM21AR72E102KW01D	DC250	X7R (EIA)	1000pF ±10%	2.0	1.25	1.0	0.7	0.3 min.
GRM188R72E152KW07D	DC250	X7R (EIA)	1500pF ±10%	1.6	0.8	0.8	0.4	0.2 to 0.5
GRM21AR72E152KW01D	DC250	X7R (EIA)	1500pF ±10%	2.0	1.25	1.0	0.7	0.3 min.
GRM188R72E222KW07D	DC250	X7R (EIA)	2200pF ±10%	1.6	0.8	0.8	0.4	0.2 to 0.5
GRM21AR72E222KW01D	DC250	X7R (EIA)	2200pF ±10%	2.0	1.25	1.0	0.7	0.3 min.
GRM21AR72E332KW01D	DC250	X7R (EIA)	3300pF ±10%	2.0	1.25	1.0	0.7	0.3 min.
GRM21AR72E472KW01D	DC250	X7R (EIA)	4700pF ±10%	2.0	1.25	1.0	0.7	0.3 min.
GRM21AR72E682KW01D	DC250	X7R (EIA)	6800pF ±10%	2.0	1.25	1.0	0.7	0.3 min.
GRM21BR72E103KW03L	DC250	X7R (EIA)	10000pF ±10%	2.0	1.25	1.25	0.7	0.3 min.
GRM31BR72E153KW01L	DC250	X7R (EIA)	15000pF ±10%	3.2	1.6	1.25	1.2	0.3 min.
GRM31BR72E223KW01L	DC250	X7R (EIA)	22000pF ±10%	3.2	1.6	1.25	1.2	0.3 min.
GRM31CR72E333KW03L	DC250	X7R (EIA)	33000pF ±10%	3.2	1.6	1.6	1.2	0.3 min.
GRM31CR72E473KW03L	DC250	X7R (EIA)	47000pF ±10%	3.2	1.6	1.6	1.2	0.3 min.
GRM31BR72E683KW01L	DC250	X7R (EIA)	68000pF ±10%	3.2	1.6	1.25	1.2	0.3 min.
GRM32QR72E683KW01L	DC250	X7R (EIA)	68000pF ±10%	3.2	2.5	1.5	1.2	0.3 min.
GRM31CR72E104KW03L	DC250	X7R (EIA)	0.10μF ±10%	3.2	1.6	1.6	1.2	0.3 min.
GRM32DR72E104KW01L	DC250	X7R (EIA)	0.10μF ±10%	3.2	2.5	2.0	1.2	0.3 min.
GRM32QR72E154KW01L	DC250	X7R (EIA)	0.15μF ±10%	3.2	2.5	1.5	1.2	0.3 min.
GRM43QR72E154KW01L	DC250	X7R (EIA)	0.15μF ±10%	4.5	3.2	1.5	2.2	0.3 min.
GRM32DR72E224KW01L	DC250	X7R (EIA)	0.22μF ±10%	3.2	2.5	2.0	1.2	0.3 min.
GRM43DR72E224KW01L	DC250	X7R (EIA)	0.22μF ±10%	4.5	3.2	2.0	2.2	0.3 min.
GRM43DR72E334KW01L	DC250	X7R (EIA)	0.33μF ±10%	4.5	3.2	2.0	2.2	0.3 min.
GRM55DR72E334KW01L	DC250	X7R (EIA)	0.33μF ±10%	5.7	5.0	2.0	3.2	0.3 min.
GRM43DR72E474KW01L	DC250	X7R (EIA)	0.47μF ±10%	4.5	3.2	2.0	2.2	0.3 min.
GRM55DR72E474KW01L	DC250	X7R (EIA)	0.47μF ±10%	5.7	5.0	2.0	3.2	0.3 min.
GRM55DR72E105KW01L	DC250	X7R (EIA)	1.0μF ±10%	5.7	5.0	2.0	3.2	0.3 min.
GRM31BR72J102KW01L	DC630	X7R (EIA)	1000pF ±10%	3.2	1.6	1.25	1.2	0.3 min.
GRM31BR72J152KW01L	DC630	X7R (EIA)	1500pF ±10%	3.2	1.6	1.25	1.2	0.3 min.

接下页。

接上页。

品名	额定电压 (V)	温度特性代号 (规格)	静电容量	长 L (mm)	宽 W (mm)	厚度 T (mm)	电极 g 最小 (mm)	电极 e (mm)
GRM31BR72J222KW01L	DC630	X7R (EIA)	2200pF ±10%	3.2	1.6	1.25	1.2	0.3 min.
GRM31BR72J332KW01L	DC630	X7R (EIA)	3300pF ±10%	3.2	1.6	1.25	1.2	0.3 min.
GRM31BR72J472KW01L	DC630	X7R (EIA)	4700pF ±10%	3.2	1.6	1.25	1.2	0.3 min.
GRM31BR72J682KW01L	DC630	X7R (EIA)	6800pF ±10%	3.2	1.6	1.25	1.2	0.3 min.
GRM31BR72J103KW01L	DC630	X7R (EIA)	10000pF ±10%	3.2	1.6	1.25	1.2	0.3 min.
GRM31CR72J153KW03L	DC630	X7R (EIA)	15000pF ±10%	3.2	1.6	1.6	1.2	0.3 min.
GRM32QR72J223KW01L	DC630	X7R (EIA)	22000pF ±10%	3.2	2.5	1.5	1.2	0.3 min.
GRM32DR72J333KW01L	DC630	X7R (EIA)	33000pF ±10%	3.2	2.5	2.0	1.2	0.3 min.
GRM32DR72J473KW01L	DC630	X7R (EIA)	47000pF ±10%	3.2	2.5	2.0	1.2	0.3 min.
GRM43QR72J683KW01L	DC630	X7R (EIA)	68000pF ±10%	4.5	3.2	1.5	2.2	0.3 min.
GRM43DR72J104KW01L	DC630	X7R (EIA)	0.10μF ±10%	4.5	3.2	2.0	2.2	0.3 min.
GRM55DR72J154KW01L	DC630	X7R (EIA)	0.15μF ±10%	5.7	5.0	2.0	3.2	0.3 min.
GRM55DR72J224KW01L	DC630	X7R (EIA)	0.22μF ±10%	5.7	5.0	2.0	3.2	0.3 min.
GRM31BR73A471KW01L	DC1000	X7R (EIA)	470pF ±10%	3.2	1.6	1.25	1.2	0.3 min.
GRM31BR73A102KW01L	DC1000	X7R (EIA)	1000pF ±10%	3.2	1.6	1.25	1.2	0.3 min.
GRM31BR73A152KW01L	DC1000	X7R (EIA)	1500pF ±10%	3.2	1.6	1.25	1.2	0.3 min.
GRM31BR73A222KW01L	DC1000	X7R (EIA)	2200pF ±10%	3.2	1.6	1.25	1.2	0.3 min.
GRM31BR73A332KW01L	DC1000	X7R (EIA)	3300pF ±10%	3.2	1.6	1.25	1.2	0.3 min.
GRM31BR73A472KW01L	DC1000	X7R (EIA)	4700pF ±10%	3.2	1.6	1.25	1.2	0.3 min.
GRM32QR73A682KW01L	DC1000	X7R (EIA)	6800pF ±10%	3.2	2.5	1.5	1.2	0.3 min.
GRM32QR73A103KW01L	DC1000	X7R (EIA)	10000pF ±10%	3.2	2.5	1.5	1.2	0.3 min.
GRM32DR73A153KW01L	DC1000	X7R (EIA)	15000pF ±10%	3.2	2.5	2.0	1.2	0.3 min.
GRM32DR73A223KW01L	DC1000	X7R (EIA)	22000pF ±10%	3.2	2.5	2.0	1.2	0.3 min.
GRM43DR73A333KW01L	DC1000	X7R (EIA)	33000pF ±10%	4.5	3.2	2.0	2.2	0.3 min.
GRM43DR73A473KW01L	DC1000	X7R (EIA)	47000pF ±10%	4.5	3.2	2.0	2.2	0.3 min.
GRM55DR73A104KW01L	DC1000	X7R (EIA)	0.10μF ±10%	5.7	5.0	2.0	3.2	0.3 min.

规格和测试方法

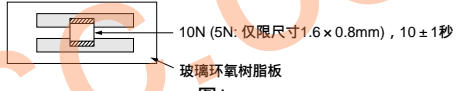
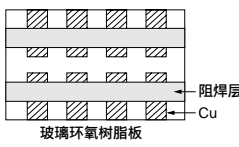
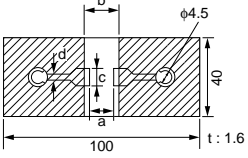
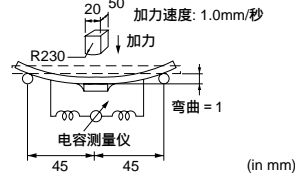
编号	项目	特性	测试方法																																							
1	动作温度范围	- 55至 + 125°C	-																																							
2	外观	无缺陷或异常	目视检查																																							
3	尺寸	在规定尺寸范围内	使用游标卡尺																																							
4	介电强度	无缺陷或异常	在端子间施加150%额定电压(额定电压: DC250V时为200%额定电压, 额定电压: DC1kV时为120%) 1至5秒时不应观察到任何故障, 并且充电/放电电流低于50mA。																																							
5	绝缘电阻 (I.R.)	C \geq 0.01 μ F: 大于100M Ω · μ F C<0.01 μ F: 大于10,000M Ω	绝缘电阻应在DC500 \pm 50V (额定电压: DC250V时为DC250V \pm 25V) 条件下, 在充电开始60 \pm 5秒分钟内测量。																																							
6	静电容量	在规定偏差范围内	静电容量/D.F.值应按1 \pm 0.2kHz的频率及AC1 \pm 0.2V (r.m.s.) 的电压进行测量。																																							
7	散逸因数 (D.F.)	最大0.025																																								
8	静电容量温度特性	静电容量变化 在 \pm 15% 范围内 (温度范围: - 55至 + 125°C)	<p>静电容量应在表中列出的各温度阶段进行测量。</p> <table border="1"> <thead> <tr> <th>阶段</th> <th>温度 (°C)</th> </tr> </thead> <tbody> <tr> <td>1</td> <td>25 \pm 2</td> </tr> <tr> <td>2</td> <td>最低动作温度 \pm 3</td> </tr> <tr> <td>3</td> <td>25 \pm 2</td> </tr> <tr> <td>4</td> <td>最高动作温度 \pm 2</td> </tr> <tr> <td>5</td> <td>25 \pm 2</td> </tr> </tbody> </table> <p>• 预处理 进行150 \pm 0/ - 10°C热处理60 \pm 5分钟, 然后在*室内条件下放置24 \pm 2小时。</p>	阶段	温度 (°C)	1	25 \pm 2	2	最低动作温度 \pm 3	3	25 \pm 2	4	最高动作温度 \pm 2	5	25 \pm 2																											
阶段	温度 (°C)																																									
1	25 \pm 2																																									
2	最低动作温度 \pm 3																																									
3	25 \pm 2																																									
4	最高动作温度 \pm 2																																									
5	25 \pm 2																																									
9	端子结合强度	不应出现端子脱落或其它缺陷。	<p>将电容器焊接在图1中所示的测试夹具(玻璃环氧树脂板)上。然后沿箭头方向施加10N的力。焊接应使用回流焊接方法进行, 而且应谨慎作业, 以使焊接均匀且不会由于热冲击产生缺陷。</p>  <p>10N (5N: 仅限尺寸1.6 \times 0.8mm), 10 \pm 1秒 玻璃环氧树脂板 图1</p>																																							
10	振荡电阻	<p>外观: 无缺陷或异常</p> <p>静电容量: 在规定偏差范围内</p> <p>D.F.: 最大0.025</p>	<p>将电容器焊接在测试夹具(玻璃环氧树脂板)上。电容器应进行简谐运动, 其总幅值为1.5mm, 频率在近似10至55Hz之间均匀变化。频率范围(从10至55Hz再返回10Hz)应在约1分钟内完成。振动应在3个相互垂直方向各进行2小时(总计6小时)。</p>  <p>阻焊层 Cu 玻璃环氧树脂板</p>																																							
11	弯曲强度	<p>不应出现裂缝或明显的缺陷。</p>  <table border="1"> <thead> <tr> <th rowspan="2">长 \times 宽 (mm)</th> <th colspan="4">尺寸 (mm)</th> <th rowspan="2">1.0</th> </tr> <tr> <th>a</th> <th>b</th> <th>c</th> <th>d</th> </tr> </thead> <tbody> <tr> <td>1.6 \times 0.8</td> <td>1.0</td> <td>3.0</td> <td>1.2</td> <td></td> </tr> <tr> <td>2.0 \times 1.25</td> <td>1.2</td> <td>4.0</td> <td>1.65</td> <td></td> </tr> <tr> <td>3.2 \times 1.6</td> <td>2.2</td> <td>5.0</td> <td>2.0</td> <td></td> </tr> <tr> <td>3.2 \times 2.5</td> <td>2.2</td> <td>5.0</td> <td>2.9</td> <td></td> </tr> <tr> <td>4.5 \times 3.2</td> <td>3.5</td> <td>7.0</td> <td>3.7</td> <td></td> </tr> <tr> <td>5.7 \times 5.0</td> <td>4.5</td> <td>8.0</td> <td>5.6</td> <td></td> </tr> </tbody> </table> <p>图2</p>  <p>20 50 加力速度: 1.0mm/秒 加力 R230 电容测量仪 弯曲=1 45 45 (in mm) 图3</p>	长 \times 宽 (mm)	尺寸 (mm)				1.0	a	b	c	d	1.6 \times 0.8	1.0	3.0	1.2		2.0 \times 1.25	1.2	4.0	1.65		3.2 \times 1.6	2.2	5.0	2.0		3.2 \times 2.5	2.2	5.0	2.9		4.5 \times 3.2	3.5	7.0	3.7		5.7 \times 5.0	4.5	8.0	5.6	
长 \times 宽 (mm)	尺寸 (mm)				1.0																																					
	a	b	c	d																																						
1.6 \times 0.8	1.0	3.0	1.2																																							
2.0 \times 1.25	1.2	4.0	1.65																																							
3.2 \times 1.6	2.2	5.0	2.0																																							
3.2 \times 2.5	2.2	5.0	2.9																																							
4.5 \times 3.2	3.5	7.0	3.7																																							
5.7 \times 5.0	4.5	8.0	5.6																																							
12	端子可焊性	75%端子需均匀且连续焊接。	<p>将电容器浸在乙醇 (JIS-K-8101) 和松香 (JIS-K-5902) (松香占25%的重量) 溶液中。浸泡在焊锡溶液2 \pm 0.5秒。 浸泡速度: 25 \pm 2.5mm/秒 焊锡温度: 245 \pm 5°C 无铅焊料 (Sn-3.0Ag-0.5Cu) 235 \pm 5°C H60A或H63A 共晶锡</p>																																							

* "室内条件" 温度: 15至35°C, 相对湿度: 45至75%, 大气压: 86至106kPa

接下页。 

规格和测试方法

接上页。

编号	项目	特性	测试方法															
13	耐焊热性	外观	无明显缺陷															
		静电容量变化	在 ± 10% 范围内															
		D.F.	最大0.025															
		绝缘电阻	C ≥ 0.01 μF: 大于100MΩ · μF C < 0.01 μF: 大于10,000MΩ															
		介电强度	按照第4项															
			在120至150°C* 范围内预热电容器1分钟。 将电容器浸泡在260 ± 5°C的共晶锡溶液10 ± 1秒。 撤到*室内条件下放置24 ± 2小时，然后进行测量。 • 浸泡速度: 25 ± 2.5mm/秒 • 预处理 进行150 + 0/ - 10°C热处理60 ± 5分钟，然后在*室内条件下放置24 ± 2小时。 *预热3.2 × 2.5mm以上															
			<table border="1"> <thead> <tr> <th>阶段</th> <th>温度</th> <th>时间</th> </tr> </thead> <tbody> <tr> <td>1</td> <td>100°C至120°C</td> <td>1分钟</td> </tr> <tr> <td>2</td> <td>170°C至200°C</td> <td>1分钟</td> </tr> </tbody> </table>	阶段	温度	时间	1	100°C至120°C	1分钟	2	170°C至200°C	1分钟						
阶段	温度	时间																
1	100°C至120°C	1分钟																
2	170°C至200°C	1分钟																
14	温度周期	外观	无明显缺陷															
		静电容量变化	在 ± 7.5% 范围内															
		D.F.	最大0.025															
		绝缘电阻	C ≥ 0.01 μF: 大于100MΩ · μF C < 0.01 μF: 大于10,000MΩ															
		介电强度	按照第4项															
			将电容器固定在图4中所示的支撑夹具(玻璃环氧树脂板)上。 按照下表所列出的4种热处理方法执行5个周期。 在*室内条件下放置24 ± 2小时，然后进行测量。															
			<table border="1"> <thead> <tr> <th>阶段</th> <th>温度(°C)</th> <th>时间(分钟)</th> </tr> </thead> <tbody> <tr> <td>1</td> <td>最低动作温度 ± 3</td> <td>30 ± 3</td> </tr> <tr> <td>2</td> <td>常温</td> <td>2至3</td> </tr> <tr> <td>3</td> <td>最高动作温度 ± 2</td> <td>30 ± 3</td> </tr> <tr> <td>4</td> <td>常温</td> <td>2至3</td> </tr> </tbody> </table>	阶段	温度(°C)	时间(分钟)	1	最低动作温度 ± 3	30 ± 3	2	常温	2至3	3	最高动作温度 ± 2	30 ± 3	4	常温	2至3
阶段	温度(°C)	时间(分钟)																
1	最低动作温度 ± 3	30 ± 3																
2	常温	2至3																
3	最高动作温度 ± 2	30 ± 3																
4	常温	2至3																
			• 预处理 进行150 + 0/ - 10°C热处理60 ± 5分钟，然后在*室内条件下放置24 ± 2小时。 															
15	湿度(静态)	外观	无明显缺陷															
		静电容量变化	在 ± 15% 范围内															
		D.F.	最大0.05															
		绝缘电阻	C ≥ 0.01 μF: 大于10MΩ · μF C < 0.01 μF: 大于1,000MΩ															
		介电强度	按照第4项															
			将电容器在40 ± 2°C及90至95%相对湿度条件下放置500 + 24/ - 0小时。 撤到*室内条件下放置24 ± 2小时，然后进行测量。 • 预处理 进行150 + 0/ - 10°C热处理60 ± 5分钟，然后在*室内条件下放置24 ± 2小时。															
16	寿命	外观	无明显缺陷															
		静电容量变化	在 ± 15% 范围内 (额定电压: DC250V, DC630V) 在 ± 20% 范围内 (额定电压: DC1kV)															
		D.F.	最大0.05															
		绝缘电阻	C ≥ 0.01 μF: 大于10MΩ · μF C < 0.01 μF: 大于1,000MΩ															
		介电强度	按照第4项															
			在最高动作温度 ± 3°C的条件下，施加120%额定电压(额定电压: DC250V时为150%额定电压，额定电压: DC1kV时为110%) 1,000 + 48/ - 0小时。撤到*室内条件下放置24 ± 2小时，然后进行测量。 充电/放电电流低于50mA。 • 预处理 在测试温度下施加测试电压60 ± 5分钟。 撤到*室内条件下放置24 ± 2小时。															
17	湿度负荷(用于: DC250V、DC630V产品)	外观	无明显缺陷															
		静电容量变化	在 ± 15% 范围内															
		D.F.	最大0.05															
		绝缘电阻	C ≥ 0.01 μF: 大于10MΩ · μF C < 0.01 μF: 大于1,000MΩ															
		介电强度	按照第4项															
			在40 ± 2°C及90至95%相对湿度条件下放置500 + 24/ - 0小时。 撤到*室内条件下放置24 ± 2小时，然后进行测量。 • 预处理 在测试温度下施加测试电压60 ± 5分钟。 撤到*室内条件下放置24 ± 2小时。															

* "室内条件" 温度: 15至35°C, 相对湿度: 45至75%, 大气压: 86至106kPa

片状独石陶瓷电容器



LCD背光灯反相电路专用

特点

1. 损耗小，适合高频电路。
2. 村田的独创内部电极结构可承受高击穿电压。
3. 新型独石结构，可用于细小、表面贴装装置，能在高电压下工作。
4. 镀锡外部电极实现了良好的可焊性。
5. 仅适用回流焊接。
6. 22pF以下电容可在最大4.0kVp-p/ 100kHz条件下使用，但是仅限于在LCD背光灯反相电路中作为镇流或共振用时。

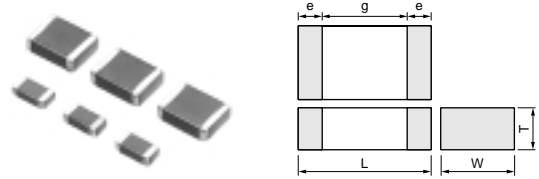

Part Number	Dimensions (mm)				
	L	W	T	e min.	g min.
GRM42A	4.5 ±0.3	2.0 ±0.2	1.0 +0, -0.3	0.3	2.9

用途

最适合用作LCD背光式变频器的镇流器。

请勿将这些产品用于汽车动力总成或安全设备，包括电动车和插入式混合动力车的充电器。

只有产品指南上明确标有“车用”的产品才可用于诸如动力传动和安全设备等汽车应用。

品名	额定电压 (V)	温度特性代号 (规格)	静电容量 (pF)	长 L (mm)	宽 W (mm)	厚度 T (mm)	电极 g 最小 (mm)	电极 e (mm)
GRM42A5C3F050DW01L	DC3150	C0G (EIA)	5.0 ±0.5pF	4.5	2.0	1.0	2.9	0.3 min.
GRM42A5C3F100JW01L	DC3150	C0G (EIA)	10 ±5%	4.5	2.0	1.0	2.9	0.3 min.
GRM42A5C3F120JW01L	DC3150	C0G (EIA)	12 ±5%	4.5	2.0	1.0	2.9	0.3 min.
GRM42A5C3F150JW01L	DC3150	C0G (EIA)	15 ±5%	4.5	2.0	1.0	2.9	0.3 min.
GRM42A5C3F180JW01L	DC3150	C0G (EIA)	18 ±5%	4.5	2.0	1.0	2.9	0.3 min.
GRM42A5C3F220JW01L	DC3150	C0G (EIA)	22 ±5%	4.5	2.0	1.0	2.9	0.3 min.
GRM42A5C3F270JW01L	DC3150	C0G (EIA)	27 ±5%	4.5	2.0	1.0	2.9	0.3 min.
GRM42A5C3F330JW01L	DC3150	C0G (EIA)	33 ±5%	4.5	2.0	1.0	2.9	0.3 min.
GRM42A5C3F390JW01L	DC3150	C0G (EIA)	39 ±5%	4.5	2.0	1.0	2.9	0.3 min.
GRM42A5C3F470JW01L	DC3150	C0G (EIA)	47 ±5%	4.5	2.0	1.0	2.9	0.3 min.

11

规格和测试方法

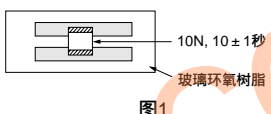
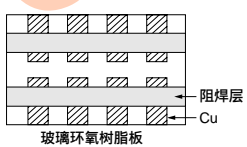
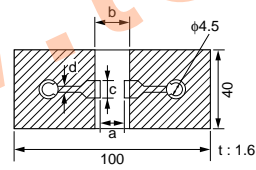
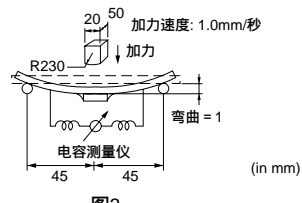
编号	项目	特性	测试方法														
1	动作温度范围	- 55至 + 125°C	-														
2	外观	无缺陷或异常	目视检查														
3	尺寸	在规定尺寸范围内	使用游标卡尺														
4	介电强度	无缺陷或异常	将DC4095V施加在端子上1至5秒时不应观察到任何故障, 并且充电 / 放电电流低于50mA。														
5	绝缘电阻 (I.R.)	大于10,000MΩ	绝缘电阻应在DC500 ± 50V条件下、在充电开始60 ± 5秒内测量。														
6	静电容量	在规定偏差范围内	静电容量/Q值应在1 ± 0.2MHz的频率及AC0.5至5V (r.m.s.) 的电压条件下进行测量。														
7	Q	最小1,000															
8	静电容量温度特性	温度系数 0 ± 30ppm/°C (温度范围: + 25至 + 125°C) 0 + 30, - 72ppm/°C (温度范围: - 55至 + 25°C)	静电容量应在表中列出的各温度阶段进行测量。 <table border="1"> <thead> <tr> <th>阶段</th> <th>温度 (°C)</th> </tr> </thead> <tbody> <tr> <td>1</td> <td>25 ± 2</td> </tr> <tr> <td>2</td> <td>最低动作温度 ± 3</td> </tr> <tr> <td>3</td> <td>25 ± 2</td> </tr> <tr> <td>4</td> <td>最高动作温度 ± 2</td> </tr> <tr> <td>5</td> <td>25 ± 2</td> </tr> </tbody> </table>	阶段	温度 (°C)	1	25 ± 2	2	最低动作温度 ± 3	3	25 ± 2	4	最高动作温度 ± 2	5	25 ± 2		
阶段	温度 (°C)																
1	25 ± 2																
2	最低动作温度 ± 3																
3	25 ± 2																
4	最高动作温度 ± 2																
5	25 ± 2																
9	端子结合强度	不应出现端子脱落或其它缺陷。	将电容器焊接在图1中所示的测试夹具 (玻璃环氧树脂板) 上。然后沿箭头方向施加10N的力。 焊接应使用回流焊接方法进行, 而且应谨慎作业, 以使焊接均匀且不会由于热冲击产生缺陷。  图1														
10	外观	无缺陷或异常	将电容器焊接在测试夹具 (玻璃环氧树脂板) 上。电容器应进行简谐运动, 其总幅值为1.5mm, 频率在近似10至55Hz之间均匀变化。频率范围 (从10至55Hz再返回10Hz) 应在约1分钟内完成。振动应在3个相互垂直方向各进行2小时 (总计6小时)。  玻璃环氧树脂板														
	静电容量	在规定偏差范围内															
	Q	最小1,000															
11	弯曲强度	不应出现裂缝或明显缺陷。  <table border="1"> <thead> <tr> <th rowspan="2">长 × 宽 (mm)</th> <th colspan="4">尺寸 (mm)</th> </tr> <tr> <th>a</th> <th>b</th> <th>c</th> <th>d</th> </tr> </thead> <tbody> <tr> <td>4.5 × 2.0</td> <td>3.5</td> <td>7.0</td> <td>2.4</td> <td>1.0</td> </tr> </tbody> </table> 图2	长 × 宽 (mm)	尺寸 (mm)				a	b	c	d	4.5 × 2.0	3.5	7.0	2.4	1.0	将电容器焊接在图2中所示的测试夹具 (玻璃环氧树脂板) 上。然后在图3所示的方向加力。 焊接应使用回流焊接方法进行, 而且应谨慎作业, 以使焊接均匀且不会由于热冲击产生缺陷。  图3
长 × 宽 (mm)	尺寸 (mm)																
	a	b	c	d													
4.5 × 2.0	3.5	7.0	2.4	1.0													
12	端子可焊性	75%端子需均匀且连续焊接。	将电容器浸在乙醇 (JIS-K-8101) 和松香 (JIS-K-5902) (松香占25%的重量) 溶液中。浸泡在焊锡溶液2 ± 0.5秒。 浸泡速度: 25 ± 2.5mm/秒 焊锡温度: 245 ± 5°C 无铅焊料 (Sn-3.0Ag-0.5Cu) 235 ± 5°C H60A或H63A 共晶锡														
13	外观	无明显缺陷	按照下表预热电容器。 将电容器浸泡在260 ± 5°C的共晶锡溶液10 ± 1秒。 撤到*室内条件下放置24 ± 2小时, 然后进行测量。 浸泡速度: 25 ± 2.5mm/秒 *预热 <table border="1"> <thead> <tr> <th>阶段</th> <th>温度</th> <th>时间</th> </tr> </thead> <tbody> <tr> <td>1</td> <td>100°C至120°C</td> <td>1分钟</td> </tr> <tr> <td>2</td> <td>170°C至200°C</td> <td>1分钟</td> </tr> </tbody> </table>	阶段	温度	时间	1	100°C至120°C	1分钟	2	170°C至200°C	1分钟					
	阶段	温度		时间													
	1	100°C至120°C		1分钟													
	2	170°C至200°C		1分钟													
	静电容量变化	在 ± 2.5% 范围内															
Q	最小1,000																
绝缘电阻	大于10,000MΩ																
介电强度	按照第4项																

接下页。 

规格和测试方法

☐ 接上页。

编号	项目	特性	测试方法	
14	温度周期	外观	将电容器焊接在图4中所示的支撑夹具(玻璃环氧树脂板)上。 按照下表中列出的4种热处理方法执行5个周期。 在*室内条件下放置 24 ± 2 小时，然后进行测量。	
		静电容量变化		在 $\pm 2.5\%$ 范围内
		Q		最小1,000
		绝缘电阻		大于10,000M Ω
		介电强度		按照第4项
15	湿度(稳态)	外观	将电容器在 $40 \pm 2^\circ\text{C}$ 及90至95%相对湿度条件下放置 $500 + 24/-0$ 小时。 撤到*室内条件下放置 24 ± 2 小时，然后进行测量。	
		静电容量变化		在 $\pm 5.0\%$ 范围内
		Q		最小350
		绝缘电阻		大于1,000M Ω
		介电强度		按照第4项
16	寿命	外观	在最高动作温度 $\pm 3^\circ\text{C}$ 条件下施加120%额定电压 $1000 + 48/-0$ 小时。 撤到*室内条件下放置 24 ± 2 小时，然后进行测量。 充电/放电电流低于50mA。	
		静电容量变化		在 $\pm 3.0\%$ 范围内
		Q		最小350
		绝缘电阻		大于1,000M Ω
		介电强度		按照第4项

阶段	温度(°C)	时间(分钟)
1	最低动作温度 ± 3	30 ± 3
2	常温	2至3
3	最高动作温度 ± 2	30 ± 3
4	常温	2至3

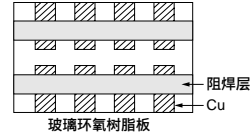

* "室内条件" 温度: 15至35°C, 相对湿度: 45至75%, 大气压: 86至106kPa

片状独石陶瓷电容器



信息设备专用

特点

1. 这些产品专门设计用于以太局域网中的通信机器 (IEEE802.3) 和DC-DC转换器的一次 - 二次耦合。
2. 新型独石结构，体积小、静电容量高，能在高电压下工作。
3. 镀锡外部电极实现了良好的可焊性。
4. 仅适用回流焊接。
5. 提供薄型 (厚度: 最大1.5mm)。适用于薄型设备。

用途

1. 最适合以太局域网中通信机器使用。
2. 最适合用作DC-DC转换器的一次 - 二次耦合。

请勿将这些产品用于汽车动力总成或安全设备，包括电动车和插入式混合动力车的充电器。

只有产品指南上明确标有“车用”的产品才可用于诸如动力传动和安全设备等汽车应用。

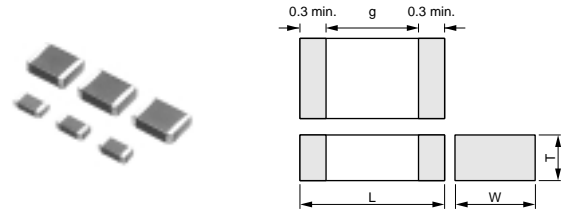

Part Number	Dimensions (mm)			
	L	W	T	g min.
GR442Q	4.5 ±0.3	2.0 ±0.2	1.5 +0, -0.3	2.5
GR443D	4.5 ±0.4	3.2 ±0.3	2.0 +0, -0.3	
GR443Q			1.5 +0, -0.3	
GR455D	5.7 ±0.4	5.0 ±0.4	2.0 +0, -0.3	3.2

品名	额定电压 (V)	温度特性代号 (规格)	静电容量 (pF)	长 L (mm)	宽 W (mm)	厚度 T (mm)	电极 g 最小 (mm)	电极 e (mm)
GR442QR73D101KW01L	DC2000	X7R (EIA)	100 ±10%	4.5	2.0	1.5	2.5	0.3 min.
GR442QR73D121KW01L	DC2000	X7R (EIA)	120 ±10%	4.5	2.0	1.5	2.5	0.3 min.
GR442QR73D151KW01L	DC2000	X7R (EIA)	150 ±10%	4.5	2.0	1.5	2.5	0.3 min.
GR442QR73D181KW01L	DC2000	X7R (EIA)	180 ±10%	4.5	2.0	1.5	2.5	0.3 min.
GR442QR73D221KW01L	DC2000	X7R (EIA)	220 ±10%	4.5	2.0	1.5	2.5	0.3 min.
GR442QR73D271KW01L	DC2000	X7R (EIA)	270 ±10%	4.5	2.0	1.5	2.5	0.3 min.
GR442QR73D331KW01L	DC2000	X7R (EIA)	330 ±10%	4.5	2.0	1.5	2.5	0.3 min.
GR442QR73D391KW01L	DC2000	X7R (EIA)	390 ±10%	4.5	2.0	1.5	2.5	0.3 min.
GR442QR73D471KW01L	DC2000	X7R (EIA)	470 ±10%	4.5	2.0	1.5	2.5	0.3 min.
GR442QR73D561KW01L	DC2000	X7R (EIA)	560 ±10%	4.5	2.0	1.5	2.5	0.3 min.
GR442QR73D681KW01L	DC2000	X7R (EIA)	680 ±10%	4.5	2.0	1.5	2.5	0.3 min.
GR442QR73D821KW01L	DC2000	X7R (EIA)	820 ±10%	4.5	2.0	1.5	2.5	0.3 min.
GR442QR73D102KW01L	DC2000	X7R (EIA)	1000 ±10%	4.5	2.0	1.5	2.5	0.3 min.
GR442QR73D122KW01L	DC2000	X7R (EIA)	1200 ±10%	4.5	2.0	1.5	2.5	0.3 min.
GR442QR73D152KW01L	DC2000	X7R (EIA)	1500 ±10%	4.5	2.0	1.5	2.5	0.3 min.
GR443QR73D182KW01L	DC2000	X7R (EIA)	1800 ±10%	4.5	3.2	1.5	2.5	0.3 min.
GR443QR73D222KW01L	DC2000	X7R (EIA)	2200 ±10%	4.5	3.2	1.5	2.5	0.3 min.
GR443QR73D272KW01L	DC2000	X7R (EIA)	2700 ±10%	4.5	3.2	1.5	2.5	0.3 min.
GR443QR73D332KW01L	DC2000	X7R (EIA)	3300 ±10%	4.5	3.2	1.5	2.5	0.3 min.
GR443QR73D392KW01L	DC2000	X7R (EIA)	3900 ±10%	4.5	3.2	1.5	2.5	0.3 min.
GR443DR73D472KW01L	DC2000	X7R (EIA)	4700 ±10%	4.5	3.2	2.0	2.5	0.3 min.
GR455DR73D103KW01L	DC2000	X7R (EIA)	10000 ±10%	5.7	5.0	2.0	3.2	0.3 min.

规格和测试方法

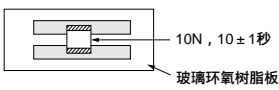
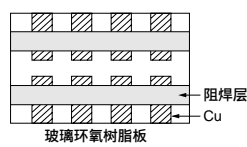
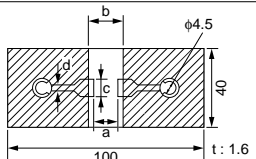
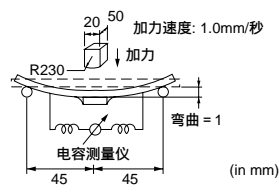
编号	项目	特性	测试方法																							
1	动作温度范围	- 55至 + 125°C	-																							
2	外观	无缺陷或异常	目视检查																							
3	尺寸	在规定尺寸范围内	使用游标卡尺																							
4	介电强度	无缺陷或异常	在端子间施加表中的电压时不应观察到任何故障，并且充电/放电电流低于50mA。 <table border="1"> <thead> <tr> <th>额定电压</th> <th>测试电压</th> <th>时间</th> </tr> </thead> <tbody> <tr> <td rowspan="2">DC2kV</td> <td>120%额定电压</td> <td>60 ± 1秒</td> </tr> <tr> <td>AC1500V(r.m.s.)</td> <td>60 ± 1秒</td> </tr> </tbody> </table>	额定电压	测试电压	时间	DC2kV	120%额定电压	60 ± 1秒	AC1500V(r.m.s.)	60 ± 1秒															
额定电压	测试电压	时间																								
DC2kV	120%额定电压	60 ± 1秒																								
	AC1500V(r.m.s.)	60 ± 1秒																								
5	冲激电压	电容器中未发生自愈的故障或闪络。	进行10次交替极性脉冲。 (每个极性各5次) 脉冲间隔为60秒。 外加电压: 零到峰值2.5kV																							
6	绝缘电阻 (I.R.)	大于6,000MΩ	绝缘电阻应在DC500 ± 50V条件下，在充电开始60 ± 5秒分钟内测量。																							
7	静电容量	在规定偏差范围内	静电容量/D.F.值应在1 ± 0.2kHz的频率及AC1 ± 0.2V (r.m.s) 的电压条件下进行测量。																							
8	散逸因数 (D.F.)	最大0.025																								
9	静电容量温度特性	静电容量变化在 ± 15%范围内 (温度范围: - 55至 + 125°C)	静电容量应在表中列出的各温度阶段进行测量。 <table border="1"> <thead> <tr> <th>阶段</th> <th>温度 (°C)</th> </tr> </thead> <tbody> <tr> <td>1</td> <td>25 ± 2</td> </tr> <tr> <td>2</td> <td>最低动作温度 ± 3</td> </tr> <tr> <td>3</td> <td>25 ± 2</td> </tr> <tr> <td>4</td> <td>最高动作温度 ± 2</td> </tr> <tr> <td>5</td> <td>25 ± 2</td> </tr> </tbody> </table> <p>· 预处理 进行150 + 0/- 10°C热处理60 ± 5分钟，然后在*室内条件下放置24 ± 2小时。</p>	阶段	温度 (°C)	1	25 ± 2	2	最低动作温度 ± 3	3	25 ± 2	4	最高动作温度 ± 2	5	25 ± 2											
阶段	温度 (°C)																									
1	25 ± 2																									
2	最低动作温度 ± 3																									
3	25 ± 2																									
4	最高动作温度 ± 2																									
5	25 ± 2																									
10	端子结合强度	不应出现端子脱落或其它缺陷。	将电容器焊接在图1中所示的测试夹具 (玻璃环氧树脂板)上。然后沿箭头方向施加10N的力。 焊接应使用回流焊接方法进行，而且应谨慎作业，以使焊接均匀且不会由于热冲击产生缺陷。  <p>图1</p>																							
11	外观	无缺陷或异常	将电容器焊接在测试夹具 (玻璃环氧树脂板)上。电容器应进行简谐运动，其总幅值为1.5mm，频率在近似10至55Hz之间均匀变化。频率范围 (从10至55Hz再返回10Hz) 应在约1分钟内完成。振动应在3个相互垂直方向各进行2小时 (总计6小时)。  <p>图2</p>																							
	静电容量	在规定偏差范围内																								
	D.F.	最大0.025																								
12	弯曲强度	不应出现裂缝或明显的缺陷。  <table border="1"> <thead> <tr> <th rowspan="2">长 × 宽 (mm)</th> <th colspan="4">尺寸 (mm)</th> <th rowspan="2">d</th> </tr> <tr> <th>a</th> <th>b</th> <th>c</th> <th>d</th> </tr> </thead> <tbody> <tr> <td>4.5 × 2.0</td> <td>3.5</td> <td>7.0</td> <td>2.4</td> <td rowspan="3">1.0</td> </tr> <tr> <td>4.5 × 3.2</td> <td>3.5</td> <td>7.0</td> <td>3.7</td> </tr> <tr> <td>5.7 × 5.0</td> <td>4.5</td> <td>8.0</td> <td>5.6</td> </tr> </tbody> </table> <p>图2</p>	长 × 宽 (mm)	尺寸 (mm)				d	a	b	c	d	4.5 × 2.0	3.5	7.0	2.4	1.0	4.5 × 3.2	3.5	7.0	3.7	5.7 × 5.0	4.5	8.0	5.6	将电容器焊接在图2中所示的测试夹具 (玻璃环氧树脂板)上。然后在图3所示的方向加力。 焊接应使用回流焊接方法进行，而且应谨慎作业，以使焊接均匀且不会由于热冲击产生缺陷。  <p>图3</p>
长 × 宽 (mm)	尺寸 (mm)				d																					
	a	b	c	d																						
4.5 × 2.0	3.5	7.0	2.4	1.0																						
4.5 × 3.2	3.5	7.0	3.7																							
5.7 × 5.0	4.5	8.0	5.6																							

* "室内条件" 温度: 15至35°C, 相对湿度: 45至75%, 大气压: 86至106kPa

接下页。 

规格和测试方法

接上页。

编号	项目	特性	测试方法															
13	端子可焊性	75%端子需均匀且连续焊接。	将电容器浸在乙醇 (JIS-K-8101) 和松香 (JIS-K-5902) (松香占25%的重量) 溶液中。浸泡在焊锡溶液 2 ± 0.5 秒。 浸泡速度: 25 ± 2.5 mm/秒 焊锡温度: $245 \pm 5^\circ\text{C}$ 无铅焊料 (Sn-3.0Ag-0.5Cu) $235 \pm 5^\circ\text{C}$ H60A或H63A 共晶锡															
14	耐焊热性	外观	按下表预热电容器。 将电容器浸泡在 $260 \pm 5^\circ\text{C}$ 的共晶锡溶液 10 ± 1 秒。 撤到*室内条件下放置 24 ± 2 小时，然后进行测量。 • 浸泡速度: 25 ± 2.5 mm/秒 • 预处理 进行 $150 + 0 / - 10^\circ\text{C}$ 热处理 60 ± 5 分钟，然后在*室内条件下放置 24 ± 2 小时。 *预热 <table border="1" style="margin-left: 20px;"> <thead> <tr> <th>阶段</th> <th>温度</th> <th>时间</th> </tr> </thead> <tbody> <tr> <td>1</td> <td>100°C至120°C</td> <td>1分钟</td> </tr> <tr> <td>2</td> <td>170°C至200°C</td> <td>1分钟</td> </tr> </tbody> </table>	阶段	温度	时间	1	100°C 至 120°C	1分钟	2	170°C 至 200°C	1分钟						
		阶段		温度	时间													
		1		100°C 至 120°C	1分钟													
		2		170°C 至 200°C	1分钟													
静电容量变化	在 $\pm 10\%$ 范围内																	
D.F.	最大0.025																	
	绝缘电阻	大于 $1,000\text{M}\Omega$																
	介电强度	按照第4项																
15	温度周期	外观	将电容器固定在图4中所示的支撑夹具 (玻璃环氧树脂板) 上。 按照下表中列出的4种热处理方法执行5个周期。 在*室内条件下放置 24 ± 2 小时，然后进行测量。 <table border="1" style="margin-left: 20px;"> <thead> <tr> <th>阶段</th> <th>温度 ($^\circ\text{C}$)</th> <th>时间 (分钟)</th> </tr> </thead> <tbody> <tr> <td>1</td> <td>最低动作温度 ± 3</td> <td>30 ± 3</td> </tr> <tr> <td>2</td> <td>常温</td> <td>2至3</td> </tr> <tr> <td>3</td> <td>最高动作温度 ± 2</td> <td>30 ± 3</td> </tr> <tr> <td>4</td> <td>常温</td> <td>2至3</td> </tr> </tbody> </table> • 预处理 进行 $150 + 0 / - 10^\circ\text{C}$ 热处理 60 ± 5 分钟，然后在*室内条件下放置 24 ± 2 小时。 	阶段	温度 ($^\circ\text{C}$)	时间 (分钟)	1	最低动作温度 ± 3	30 ± 3	2	常温	2至3	3	最高动作温度 ± 2	30 ± 3	4	常温	2至3
		阶段		温度 ($^\circ\text{C}$)	时间 (分钟)													
		1		最低动作温度 ± 3	30 ± 3													
		2		常温	2至3													
		3		最高动作温度 ± 2	30 ± 3													
4	常温	2至3																
静电容量变化	在 $\pm 15\%$ 范围内																	
D.F.	最大0.05																	
绝缘电阻	大于 $3,000\text{M}\Omega$																	
介电强度	按照第4项																	
16	湿度 (静态)	外观	将电容器在 $40 \pm 2^\circ\text{C}$ 及90至95%相对湿度条件下放置 $500 + 24 / - 0$ 小时。 撤到*室内条件下放置 24 ± 2 小时，然后进行测量。 • 预处理 进行 $150 + 0 / - 10^\circ\text{C}$ 热处理 60 ± 5 分钟，然后在*室内条件下放置 24 ± 2 小时。															
		静电容量变化		在 $\pm 15\%$ 范围内														
		D.F.		最大0.05														
		绝缘电阻		大于 $1,000\text{M}\Omega$														
		介电强度		按照第4项														
17	寿命	外观	在最高动作温度 $\pm 3^\circ\text{C}$ 的条件下，施加110%额定电压 $1,000 + 48 / - 0$ 小时。撤到*室内条件下放置 24 ± 2 小时，然后进行测量。 充电/放电电流低于50mA。 • 预处理 在测试温度下施加测试电压 60 ± 5 分钟。 撤到*室内条件下放置 24 ± 2 小时。															
		静电容量变化		在 $\pm 20\%$ 范围内														
		D.F.		最大0.05														
		绝缘电阻		大于 $2,000\text{M}\Omega$														
		介电强度		按照第4项														

* "室内条件" 温度: 15至 35°C , 相对湿度: 45至75%, 大气压: 86至 106kPa

片状独石陶瓷电容器



照相机闪光电路专用

特点

1. 因为实际静电容量稳定在动作电压下，适合于闪光电路的触发。
2. 其薄型构造适合于薄型照相机。
3. 镀锡外部电极实现了良好的可焊性。
4. 同时适用波峰及回流焊接。

用途

闪光电路

请勿将这些产品用于汽车动力总成或安全设备，包括电动车和插入式混合动力车的充电器。
 只有产品指南上明确标有“车用”的产品才可用于诸如动力传动和安全设备等汽车应用。

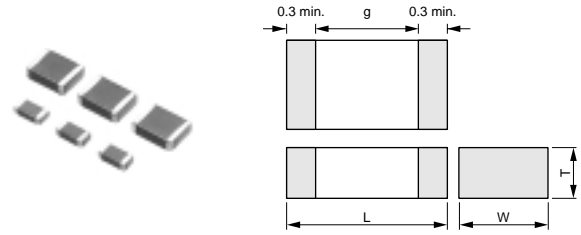

Part Number	Dimensions (mm)			
	L	W	T	g min.
GR731A	3.2 ±0.2	1.6 ±0.2	1.0 +0, -0.3	1.2
GR731B			1.25 +0, -0.3	
GR731C			1.6 ±0.2	

品名	额定电压 (V)	温度特性代号 (规格)	静电容量 (pF)	长 L (mm)	宽 W (mm)	厚度 T (mm)	电极 g 最小 (mm)	电极 e (mm)
GR731AW0BB103KW01D	DC350	-	10000 ±10%	3.2	1.6	1.0	1.2	0.3 min.
GR731AW0BB153KW01D	DC350	-	15000 ±10%	3.2	1.6	1.0	1.2	0.3 min.
GR731BW0BB223KW01L	DC350	-	22000 ±10%	3.2	1.6	1.25	1.2	0.3 min.
GR731BW0BB333KW01L	DC350	-	33000 ±10%	3.2	1.6	1.25	1.2	0.3 min.
GR731CW0BB473KW03L	DC350	-	47000 ±10%	3.2	1.6	1.6	1.2	0.3 min.

规格和测试方法

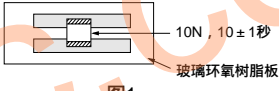
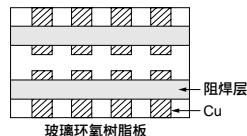
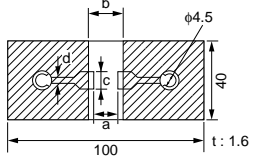
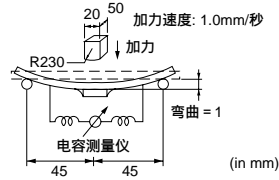
编号	项目	特性	测试方法												
1	动作温度范围	- 55至 + 125°C	-												
2	外观	无缺陷或异常	目视检查												
3	尺寸	在规定尺寸范围内	使用游标卡尺												
4	介电强度	无缺陷或异常	在端子中施加DC500V1至5秒时不应观察到任何故障，并且充电/放电电流低于50mA。												
5	绝缘电阻 (I.R.)	C ≥ 0.01μF: 大于100MΩ · μF C < 0.01μF: 大于10,000MΩ	绝缘电阻应在DC250 ± 50V条件下，在充电开始60 ± 5秒分钟内测量。												
6	静电容量	在规定偏差范围内	静电容量/D.F. 值应在1 ± 0.2kHz的频率及AC1 ± 0.2V (r.m.s.) 的电压条件下进行测量。												
7	散逸因数 (D.F.)	最大0.025													
8	静电容量温度特性	静电容量变化 在 ± 10% 范围内 (加DC350V/偏压) 在 + 22/ - 33% 范围内 (无DC偏压) (温度范围: - 55至 + 125°C)	<p>静电容量应在表中列出的各温度阶段进行测量。</p> <table border="1"> <thead> <tr> <th>阶段</th> <th>温度 (°C)</th> </tr> </thead> <tbody> <tr> <td>1</td> <td>25 ± 2</td> </tr> <tr> <td>2</td> <td>最低动作温度 ± 3</td> </tr> <tr> <td>3</td> <td>25 ± 2</td> </tr> <tr> <td>4</td> <td>最高动作温度 ± 2</td> </tr> <tr> <td>5</td> <td>25 ± 2</td> </tr> </tbody> </table> <p>• 预处理 进行150 + 0/ - 10°C热处理60 ± 5分钟，然后在*室内条件下放置24 ± 2小时。</p>	阶段	温度 (°C)	1	25 ± 2	2	最低动作温度 ± 3	3	25 ± 2	4	最高动作温度 ± 2	5	25 ± 2
阶段	温度 (°C)														
1	25 ± 2														
2	最低动作温度 ± 3														
3	25 ± 2														
4	最高动作温度 ± 2														
5	25 ± 2														
9	端子结合强度	不应出现端子脱落或其它缺陷。	<p>将电容器焊接在图1中所示的测试夹具 (玻璃环氧树脂板) 上。然后沿箭头方向施加10N的力。焊接应使用回流焊接方法进行，而且应谨慎作业，以使焊接均匀且不会由于热冲击产生缺陷。</p>  <p>图1</p>												
10	外观	无缺陷或异常	<p>将电容器焊接在测试夹具 (玻璃环氧树脂板) 上。电容器应进行简谐运动，其总幅值为1.5mm，频率在近似10至55Hz之间均匀变化。频率范围 (从10至55Hz再返回10Hz) 应在约1分钟内完成。振动应在3个相互垂直方向各进行2小时 (总计6小时)。</p>  <p>图2</p>												
	静电容量	在规定偏差范围内													
	D.F.	最大0.025													
11	弯曲强度	不应出现裂缝或明显的缺陷。	<p>将电容器焊接在图2中所示的测试夹具 (玻璃环氧树脂板) 上。然后在图3所示的方向加力。焊接应使用回流焊接方法进行，而且应谨慎作业，以使焊接均匀且不会由于热冲击产生缺陷。</p>   <p>图3</p>												
	长 × 宽 (mm)	尺寸 (mm)													
	3.2 × 1.6	a: 2.2, b: 5.0, c: 2.0, d: 1.0													
12	端子可焊性	75%端子需均匀且连续焊接。	<p>将电容器浸在乙醇 (JIS-K-8101) 和松香 (JIS-K-5902) (松香占25%的重量) 溶液中。浸泡在焊锡溶液2 ± 0.5秒。 浸泡速度: 25 ± 2.5mm/秒 焊锡温度: 245 ± 5°C 无铅焊料 (Sn-3.0Ag-0.5Cu) 235 ± 5°C H60A或H63A 共晶锡</p>												
13	外观	无明显缺陷	<p>在120至150°C范围内预热电容器1分钟。将电容器浸泡在260 ± 5°C的共晶锡溶液10 ± 1秒。撤到*室内条件下放置24 ± 2小时，然后进行测量。</p> <p>• 浸泡速度: 25 ± 2.5mm/秒</p> <p>• 预处理 进行150 + 0/ - 10°C热处理60 ± 5分钟，然后在*室内条件下放置24 ± 2小时。</p>												
	静电容量变化	在 ± 10% 范围内													
	D.F.	最大0.025													
	绝缘电阻	C ≥ 0.01μF: 大于100MΩ · μF C < 0.01μF: 大于10,000MΩ													
	介电强度	按照第4项													

* "室内条件" 温度: 15至35°C, 相对湿度: 45至75%, 大气压: 86至106kPa

规格和测试方法

☐ 接上页。

编号	项目	特性	测试方法															
14	外观	无明显缺陷	将电容器固定在图4中所示的支撑夹具(玻璃环氧树脂板)上。按照下表中列出的4种热处理方法执行5个周期。在*室内条件下放置24±2小时，然后进行测量。 <table border="1" style="margin: 10px 0;"> <thead> <tr> <th>阶段</th> <th>温度(°C)</th> <th>时间(分钟)</th> </tr> </thead> <tbody> <tr> <td>1</td> <td>最低动作温度±3</td> <td>30±3</td> </tr> <tr> <td>2</td> <td>常温</td> <td>2至3</td> </tr> <tr> <td>3</td> <td>最高动作温度±2</td> <td>30±3</td> </tr> <tr> <td>4</td> <td>常温</td> <td>2至3</td> </tr> </tbody> </table> • 预处理 进行150+0/-10°C热处理60±5分钟，然后在*室内条件下放置24±2小时。  图4	阶段	温度(°C)	时间(分钟)	1	最低动作温度±3	30±3	2	常温	2至3	3	最高动作温度±2	30±3	4	常温	2至3
	阶段	温度(°C)		时间(分钟)														
	1	最低动作温度±3		30±3														
	2	常温		2至3														
	3	最高动作温度±2		30±3														
4	常温	2至3																
静电容量变化	在±7.5%范围内																	
D.F.	最大0.025																	
绝缘电阻	C≥0.01μF: 大于100MΩ·μF C<0.01μF: 大于10,000MΩ																	
介电强度	按照第4项																	
15	外观	无明显缺陷	将电容器在40±2°C及90至95%相对湿度条件下放置500+24/-0小时。撤到*室内条件下放置24±2小时，然后进行测量。 • 预处理 进行150+0/-10°C热处理60±5分钟，然后在*室内条件下放置24±2小时。															
	静电容量变化	在±15%范围内																
	D.F.	最大0.05																
	绝缘电阻	C≥0.01μF: 大于10MΩ·μF C<0.01μF: 大于1,000MΩ																
	介电强度	按照第4项																
16	外观	无明显缺陷	在最高动作温度±3°C的条件下，施加DC350V 1,000+48/-0小时。撤到*室内条件下放置24±2小时，然后进行测量。 充电/放电电流低于50mA。 • 预处理 在测试温度下施加测试电压60±5分钟。撤到*室内条件下放置24±2小时。															
	静电容量变化	在±15%范围内																
	D.F.	最大0.05																
	绝缘电阻	C≥0.01μF: 大于10MΩ·μF C<0.01μF: 大于1,000MΩ																
	介电强度	按照第4项																
17	外观	无明显缺陷	在40±2°C及90至95%相对湿度条件下放置500+24/-0小时。撤到*室内条件下放置24±2小时，然后进行测量。 • 预处理 在测试温度下施加测试电压60±5分钟。撤到*室内条件下放置24±2小时。															
	静电容量变化	在±15%范围内																
	D.F.	最大0.05																
	绝缘电阻	C≥0.01μF: 大于10MΩ·μF C<0.01μF: 大于1,000MΩ																
	介电强度	按照第4项																

* "室内条件" 温度: 15至35°C, 相对湿度: 45至75%, 大气压: 86至106kPa

片状独石陶瓷电容器



AC250V (r.m.s.) 型 (日本电器安全法基准品)

特点

1. 交流线路用片状独石陶瓷电容器。
2. 新型独石结构，体积小、静电容量高，能在高电压下工作。
3. 镀锡外部电极实现了良好的可焊性。
4. 仅适用回流焊接。
5. 静电容量0.01至0.1 μF 于连接线路，而470至4700pF用于将线路接地。

用途

切换式电源、电话、传真机、调制解调器的噪声抑制滤波器用。

请勿将这些产品用于汽车动力总成或安全设备，包括电动车和插入式混合动力车的充电器。
 只有产品指南上明确标有“车用”的产品才可用于诸如动力传动和安全设备等汽车应用。

参考基准

GA2系列没有取得任何安全规格认证。
 该系列根据于日本国电器安全法 (另表4)。

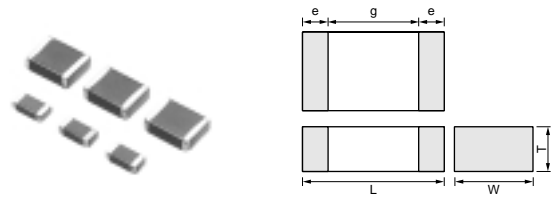

Part Number	Dimensions (mm)				
	L	W	T	e min.	g min.
GA242Q	4.5 ±0.3	2.0 ±0.2	1.5 +0, -0.3	0.3	2.5
GA243D	4.5 ±0.4	3.2 ±0.3	2.0 +0, -0.3		
GA243Q			1.5 +0, -0.3		
GA255D	5.7 ±0.4	5.0 ±0.4	2.0 +0, -0.3		3.2

品名	额定电压 (V)	温度特性代号 (规格)	静电容量	长 L (mm)	宽 W (mm)	厚度 T (mm)	电极 g 最小 (mm)	电极 e (mm)
GA242QR7E2471MW01L	AC250 (r.m.s.)	X7R (EIA)	470pF ±20%	4.5	2.0	1.5	2.5	0.3 min.
GA242QR7E2102MW01L	AC250 (r.m.s.)	X7R (EIA)	1000pF ±20%	4.5	2.0	1.5	2.5	0.3 min.
GA243QR7E2222MW01L	AC250 (r.m.s.)	X7R (EIA)	2200pF ±20%	4.5	3.2	1.5	2.5	0.3 min.
GA243QR7E2332MW01L	AC250 (r.m.s.)	X7R (EIA)	3300pF ±20%	4.5	3.2	1.5	2.5	0.3 min.
GA243DR7E2472MW01L	AC250 (r.m.s.)	X7R (EIA)	4700pF ±20%	4.5	3.2	2.0	2.5	0.3 min.
GA243QR7E2103MW01L	AC250 (r.m.s.)	X7R (EIA)	10000pF ±20%	4.5	3.2	1.5	2.5	0.3 min.
GA243QR7E2223MW01L	AC250 (r.m.s.)	X7R (EIA)	22000pF ±20%	4.5	3.2	1.5	2.5	0.3 min.
GA243DR7E2473MW01L	AC250 (r.m.s.)	X7R (EIA)	47000pF ±20%	4.5	3.2	2.0	2.5	0.3 min.
GA255DR7E2104MW01L	AC250 (r.m.s.)	X7R (EIA)	0.10 μF ±20%	5.7	5.0	2.0	3.2	0.3 min.

规格和测试方法

编号	项目	特性	测试方法												
1	动作温度范围	- 55至 + 125°C	-												
2	外观	无缺陷或异常	目视检查												
3	尺寸	在规定尺寸范围内	使用游标卡尺												
4	介电强度	无缺陷或异常	在端子间施加表中的电压60 ± 1秒时不应观察到任何故障，并且充电/放电电流低于50mA。 <table border="1" style="margin-left: 20px;"> <tr> <th>标称静电容量</th> <th>测试电压</th> </tr> <tr> <td>C ≥ 10,000pF</td> <td>AC575V(r.m.s.)</td> </tr> <tr> <td>C < 10,000pF</td> <td>AC1500V(r.m.s.)</td> </tr> </table>	标称静电容量	测试电压	C ≥ 10,000pF	AC575V(r.m.s.)	C < 10,000pF	AC1500V(r.m.s.)						
标称静电容量	测试电压														
C ≥ 10,000pF	AC575V(r.m.s.)														
C < 10,000pF	AC1500V(r.m.s.)														
5	绝缘电阻 (I.R.)	大于2,000MΩ	绝缘电阻应在DC500 ± 50V条件下、在充电开始60 ± 5秒内测量。												
6	静电容量	在规定偏差范围内	静电容量/D.F.值应在1 ± 0.2kHz的频率及AC1 ± 0.2V (r.m.s) 的电压条件下进行测量。												
7	散逸因数 (D.F.)	最大0.025													
8	静电容量温度特性	静电容量变化在 ± 15% 范围内 (温度范围: - 55至 + 125°C)	静电容量应在表中列出的各温度阶段进行测量。 <table border="1" style="margin-left: 20px;"> <tr> <th>阶段</th> <th>温度 (°C)</th> </tr> <tr> <td>1</td> <td>25 ± 2</td> </tr> <tr> <td>2</td> <td>最低动作温度 ± 3</td> </tr> <tr> <td>3</td> <td>25 ± 2</td> </tr> <tr> <td>4</td> <td>最高动作温度 ± 2</td> </tr> <tr> <td>5</td> <td>25 ± 2</td> </tr> </table> <p>• 预处理 进行150 + 0/ - 10°C热处理60 ± 5分钟，然后在“室内条件下”放置24 ± 2小时。</p>	阶段	温度 (°C)	1	25 ± 2	2	最低动作温度 ± 3	3	25 ± 2	4	最高动作温度 ± 2	5	25 ± 2
阶段	温度 (°C)														
1	25 ± 2														
2	最低动作温度 ± 3														
3	25 ± 2														
4	最高动作温度 ± 2														
5	25 ± 2														
9	放电测试 (用于: 标称静电容量 C < 10,000pF)	外观 无缺陷或异常	如图所示，按规定的直流电压充电的电容器 (Cd) 以5秒为间隔放电50次。  Ct: 被测电容器 Cd: 0.001μF R1: 1,000Ω R2: 100MΩ R3: 浪涌电阻												
10	端子结合强度	不应出现端子脱落或其它缺陷。	将电容器焊接在图1中所示的测试夹具 (玻璃环氧树脂板) 上。然后沿箭头方向施加10N的力。 焊接应使用回流焊接方法进行，而且应谨慎作业，以使焊接均匀且不会由于热冲击产生缺陷。  图1												
11	外观	无缺陷或异常	将电容器焊接在测试夹具 (玻璃环氧树脂板) 上。电容器应进行简谐运动，其总幅值为1.5mm，频率在近似10至55Hz之间均匀变化。频率范围 (从10至55Hz再返回10Hz) 应在约1分钟内完成。振动应在3个相互垂直方向各进行2小时 (总计6小时)。 												
	静电容量	在规定偏差范围内													
11	振荡电阻	D.F. 最大0.025													

* "室内条件" 温度: 15至35°C, 相对湿度: 45至75%, 大气压: 86至106kPa

接下页。 

规格和测试方法

接上页。

编号	项目	特性	测试方法																			
12	弯曲强度	不应出现裂缝或明显缺陷。	将电容器焊接在图2中所示的测试夹具(玻璃环氧树脂板)上。 然后在图3所示的方向加力。 焊接应使用回流焊接方法进行，而且应谨慎作业，以使焊接均匀且不会由于热冲击产生缺陷。																			
		 <table border="1" data-bbox="367 481 874 604"> <thead> <tr> <th rowspan="2">长 × 宽 (mm)</th> <th colspan="4">尺寸 (mm)</th> </tr> <tr> <th>a</th> <th>b</th> <th>c</th> <th>d</th> </tr> </thead> <tbody> <tr> <td>4.5 × 2.0</td> <td>3.5</td> <td>7.0</td> <td>2.4</td> <td rowspan="3">1.0</td> </tr> <tr> <td>4.5 × 3.2</td> <td>3.5</td> <td>7.0</td> <td>3.7</td> </tr> <tr> <td>5.7 × 5.0</td> <td>4.5</td> <td>8.0</td> <td>5.6</td> </tr> </tbody> </table> <p style="text-align: center;">图2</p>		长 × 宽 (mm)	尺寸 (mm)				a	b	c	d	4.5 × 2.0	3.5	7.0	2.4	1.0	4.5 × 3.2	3.5	7.0	3.7	5.7 × 5.0
长 × 宽 (mm)	尺寸 (mm)																					
	a	b	c	d																		
4.5 × 2.0	3.5	7.0	2.4	1.0																		
4.5 × 3.2	3.5	7.0	3.7																			
5.7 × 5.0	4.5	8.0	5.6																			
13	端子可焊性	75%端子需均匀且连续焊接。	将电容器浸在乙醇 (JIS-K-8101) 和松香 (JIS-K-5902) (松香占25%的重量) 溶液中。 浸泡在焊锡溶液 2 ± 0.5 秒。 浸泡速度: 25 ± 2.5 mm/秒 焊锡温度: $245 \pm 5^\circ\text{C}$ 无铅焊料 (Sn-3.0Ag-0.5Cu) $235 \pm 5^\circ\text{C}$ H60A或H63A 共晶锡																			
14	湿度绝缘	外观	无明显缺陷																			
		静电容量变化	在 $\pm 15\%$ 范围内																			
		D.F.	最大0.05																			
		绝缘电阻	大于1,000MΩ																			
		介电强度	按照第4项																			
			电容器将置于 $40 \pm 2^\circ\text{C}$ ，90至98%相对湿度条件下8小时，然后撤到*室内条件下放置16小时，如此完成5个周期。																			
15	耐焊热性	外观	无明显缺陷																			
		静电容量变化	在 $\pm 10\%$ 范围内																			
		D.F.	最大0.025																			
		绝缘电阻	大于2,000MΩ																			
		介电强度	按照第4项																			
			按下表预热电容器。 将电容器浸泡在 $260 \pm 5^\circ\text{C}$ 的共晶锡溶液 10 ± 1 秒。 在*室内条件下放置 24 ± 2 小时，然后进行测量。 • 浸泡速度: 25 ± 2.5 mm/秒 • 预处理 进行 $150 + 0/- 10^\circ\text{C}$ 热处理 60 ± 5 分钟，然后在*室内条件下放置 24 ± 2 小时。 *预热																			
			<table border="1" data-bbox="938 1227 1449 1303"> <thead> <tr> <th>阶段</th> <th>温度</th> <th>时间</th> </tr> </thead> <tbody> <tr> <td>1</td> <td>100°C至120°C</td> <td>1分钟</td> </tr> <tr> <td>2</td> <td>170°C至200°C</td> <td>1分钟</td> </tr> </tbody> </table>	阶段	温度	时间	1	100°C 至 120°C	1分钟	2	170°C 至 200°C	1分钟										
阶段	温度	时间																				
1	100°C 至 120°C	1分钟																				
2	170°C 至 200°C	1分钟																				
16	湿度周期	外观	无明显缺陷																			
		静电容量变化	在 $\pm 15\%$ 范围内																			
		D.F.	最大0.05																			
		绝缘电阻	大于2,000MΩ																			
		介电强度	按照第4项																			
			将电容器固定在图4中所示的支撑夹具(玻璃环氧树脂板)上。 按照下表中列出的4种热处理方法执行5个周期。 在*室内条件下放置 24 ± 2 小时，然后进行测量。																			
			<table border="1" data-bbox="938 1411 1449 1534"> <thead> <tr> <th>阶段</th> <th>温度 ($^\circ\text{C}$)</th> <th>时间 (分钟)</th> </tr> </thead> <tbody> <tr> <td>1</td> <td>最低动作温度 ± 3</td> <td>30 ± 3</td> </tr> <tr> <td>2</td> <td>常温</td> <td>2至3</td> </tr> <tr> <td>3</td> <td>最高动作温度 ± 2</td> <td>30 ± 3</td> </tr> <tr> <td>4</td> <td>常温</td> <td>2至3</td> </tr> </tbody> </table>	阶段	温度 ($^\circ\text{C}$)	时间 (分钟)	1	最低动作温度 ± 3	30 ± 3	2	常温	2至3	3	最高动作温度 ± 2	30 ± 3	4	常温	2至3				
阶段	温度 ($^\circ\text{C}$)	时间 (分钟)																				
1	最低动作温度 ± 3	30 ± 3																				
2	常温	2至3																				
3	最高动作温度 ± 2	30 ± 3																				
4	常温	2至3																				
			• 预处理 进行 $150 + 0/- 10^\circ\text{C}$ 热处理 60 ± 5 分钟，然后在*室内条件下放置 24 ± 2 小时。																			
			 <p style="text-align: center;">图4</p>																			
17	湿度 (稳态)	外观	无明显缺陷																			
		静电容量变化	在 $\pm 15\%$ 范围内																			
		D.F.	最大0.05																			
		绝缘电阻	大于1,000MΩ																			
		介电强度	按照第4项																			
			将电容器在 $40 \pm 2^\circ\text{C}$ 及90至95%相对湿度条件下放置 $500 + 24/- 0$ 小时。 撤到*室内条件下放置 24 ± 2 小时，然后进行测量。 • 预处理 进行 $150 + 0/- 10^\circ\text{C}$ 热处理 60 ± 5 分钟，然后在*室内条件下放置 24 ± 2 小时。																			

* "室内条件" 温度: 15至 35°C ，相对湿度: 45至75%，大气压: 86至106kPa

接下页。 ↗

规格和测试方法

☐ 接上页。

编号	项目	特性	测试方法									
18	寿命	外观	在最高工作温度 $\pm 3^{\circ}\text{C}$ 条件下，按照下表施加电压和时间。 撤到室内条件*下放置 24 ± 2 小时，然后进行测量。充电 / 放电流低于 50mA 。 <table border="1" style="margin: 5px auto;"> <thead> <tr> <th>标称静电容量</th> <th>测试时间</th> <th>测试电压</th> </tr> </thead> <tbody> <tr> <td>$C \geq 10,000\text{pF}$</td> <td>$1,000 + 48 / - 0 \text{ hrs.}$</td> <td>$\text{AC}300\text{V}(\text{r.m.s.})$</td> </tr> <tr> <td>$C < 10,000\text{pF}$</td> <td>$1,500 + 48 / - 0 \text{ hrs.}$</td> <td>$\text{AC}500\text{V}(\text{r.m.s.})^*$</td> </tr> </tbody> </table> *但每一小时内电压应增到 $\text{AC}1,000\text{V}(\text{r.m.s.})$ 一次，并保持 0.1 秒。 • 预处理 在测试温度下施加测试电压 60 ± 5 分钟。 撤到*室内条件下放置 24 ± 2 小时。	标称静电容量	测试时间	测试电压	$C \geq 10,000\text{pF}$	$1,000 + 48 / - 0 \text{ hrs.}$	$\text{AC}300\text{V}(\text{r.m.s.})$	$C < 10,000\text{pF}$	$1,500 + 48 / - 0 \text{ hrs.}$	$\text{AC}500\text{V}(\text{r.m.s.})^*$
		标称静电容量		测试时间	测试电压							
		$C \geq 10,000\text{pF}$		$1,000 + 48 / - 0 \text{ hrs.}$	$\text{AC}300\text{V}(\text{r.m.s.})$							
		$C < 10,000\text{pF}$		$1,500 + 48 / - 0 \text{ hrs.}$	$\text{AC}500\text{V}(\text{r.m.s.})^*$							
		静电容量变化		在 $\pm 20\%$ 范围内								
D.F.	最大 0.05											
绝缘电阻	大于 $1,000\text{M}\Omega$											
	介电强度	按照第4项										
19	湿度负荷	外观	在 $40 \pm 2^{\circ}\text{C}$ 及 90 至 95% 相对湿度条件下放置 $500 + 24 / - 0$ 小时。 撤到*室内条件下放置 24 ± 2 小时，然后进行测量。 • 预处理 在测试温度下施加测试电压 60 ± 5 分钟。 撤到*室内条件下放置 24 ± 2 小时。									
		静电容量变化		在 $\pm 15\%$ 范围内								
		D.F.		最大 0.05								
		绝缘电阻		大于 $1,000\text{M}\Omega$								
		介电强度		按照第4项								

* "室内条件" 温度: 15 至 35°C ，相对湿度: 45 至 75% ，大气压: 86 至 106kPa

片状独石陶瓷电容器



安全规格认证品 GC型 (UL, IEC60384-14 X1/Y2级)

特点

1. 交流线路用片状独石陶瓷电容器 (经认证符合安全标准)。
2. 新型独石结构，体积小、静电容量高，能在高电压下工作。
3. 与引线型电容器相比，本新型电容器已变得极小、极薄，其体积不超过以前的1/10，高度不超过1/4。
4. GC型可用作X1级与Y2级电容器，以及符合UL1414标准的线间旁路电容器。
5. 保证承受 + 125 。
6. 仅适用回流焊接。

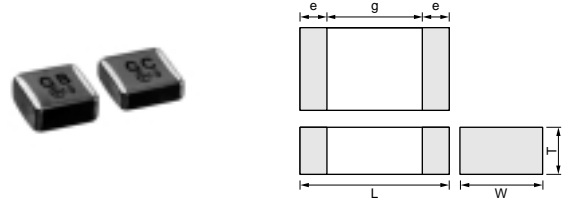

Part Number	Dimensions (mm)				
	L	W	T	e min.	g min.
GA355D	5.7 ±0.4	5.0 ±0.4	2.0 ±0.3	0.3	4.0

用途

1. 最适合用作各种切换式电源的Y电容器或X电容器
2. 最适合调制解调器用

请勿将这些产品用于汽车动力总成或安全设备，包括电动车和插入式混合动力车的充电器。
 只有产品指南上明确标有“车用”的产品才可用于诸如动力传动和安全设备等汽车应用。

安全规格认证情况

	Standard No.	Class	Rated Voltage
UL	UL1414	Line By-pass	AC250V (r.m.s.)
VDE	IEC 60384-14 EN 60384-14	X1, Y2	
BSI	EN 60065 (14.2) IEC 60384-14 EN 60384-14		
SEMKO	IEC 60384-14 EN 60384-14		
ESTI	EN 60065 IEC 60384-14		

品名	额定电压 (V)	温度特性代号 (规格)	静电容量 (pF)	长 L (mm)	宽 W (mm)	厚度 T (mm)	电极 g 最小 (mm)	电极 e (mm)
GA355DR7GC101KY02L	AC250 (r.m.s.)	X7R (EIA)	100 ±10%	5.7	5.0	2.0	4.0	0.3 min.
GA355DR7GC151KY02L	AC250 (r.m.s.)	X7R (EIA)	150 ±10%	5.7	5.0	2.0	4.0	0.3 min.
GA355DR7GC221KY02L	AC250 (r.m.s.)	X7R (EIA)	220 ±10%	5.7	5.0	2.0	4.0	0.3 min.
GA355DR7GC331KY02L	AC250 (r.m.s.)	X7R (EIA)	330 ±10%	5.7	5.0	2.0	4.0	0.3 min.

片状独石陶瓷电容器



安全规格认证品 GD型 (IEC60384-14 Y3级)

特点

1. 可用于符合IEC/EN60950及UL1950标准的机器。
2. GD型可用作Y3级电容器。
3. 新型独石结构，体积小、静电容量高，能在高电压下工作。
4. 保证承受 + 125 。
5. 仅适用回流焊接。
6. 提供低型 (厚度: 最大1.5mm)。它们适用于薄型设备。

用途

1. 最适合无变压器的DAA调制解调器线路滤波器及耦合用。
2. 最适合信息设备线路滤波器用。

请勿将这些产品用于汽车动力总成或安全设备，包括电动车和插入式混合动力车的充电器。

只有产品指南上明确标有“车用”的产品才可用于诸如动力传动和安全设备等汽车应用。

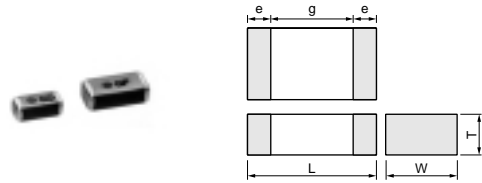

Part Number	Dimensions (mm)				
	L	W	T	e min.	g min.
GA342A	4.5 ±0.3	2.0 ±0.2	1.0 +0, -0.3	0.3	2.5
GA342D			2.0 ±0.3		
GA342Q			1.5 +0, -0.3		
GA343D	4.5 ±0.4	3.2 ±0.3	2.0 +0, -0.3		
GA343Q			1.5 +0, -0.3		

安全规格认证情况

	Standard No.	Class	Rated Voltage
UL	UL 60950-1	Y3	AC250V(r.m.s.)
SEMKO	IEC 60384-14 EN 60384-14		

Applications

Size	Switching power supplies	Communication network devices such as a modem
4.5×3.2mm and under	—	◎

品名	额定电压 (V)	温度特性代号 (规格)	静电容量 (pF)	长 L (mm)	宽 W (mm)	厚度 T (mm)	电极 g 最小 (mm)	电极 e (mm)
GA342D1XGD100JY02L	AC250 (r.m.s.)	SL (JIS)	10 ±5%	4.5	2.0	2.0	2.5	0.3 min.
GA342D1XGD120JY02L	AC250 (r.m.s.)	SL (JIS)	12 ±5%	4.5	2.0	2.0	2.5	0.3 min.
GA342D1XGD150JY02L	AC250 (r.m.s.)	SL (JIS)	15 ±5%	4.5	2.0	2.0	2.5	0.3 min.
GA342D1XGD180JY02L	AC250 (r.m.s.)	SL (JIS)	18 ±5%	4.5	2.0	2.0	2.5	0.3 min.
GA342D1XGD220JY02L	AC250 (r.m.s.)	SL (JIS)	22 ±5%	4.5	2.0	2.0	2.5	0.3 min.
GA342A1XGD270JW31L	AC250 (r.m.s.)	SL (JIS)	27 ±5%	4.5	2.0	1.0	2.5	0.3 min.
GA342A1XGD330JW31L	AC250 (r.m.s.)	SL (JIS)	33 ±5%	4.5	2.0	1.0	2.5	0.3 min.
GA342A1XGD390JW31L	AC250 (r.m.s.)	SL (JIS)	39 ±5%	4.5	2.0	1.0	2.5	0.3 min.
GA342A1XGD470JW31L	AC250 (r.m.s.)	SL (JIS)	47 ±5%	4.5	2.0	1.0	2.5	0.3 min.
GA342A1XGD560JW31L	AC250 (r.m.s.)	SL (JIS)	56 ±5%	4.5	2.0	1.0	2.5	0.3 min.
GA342A1XGD680JW31L	AC250 (r.m.s.)	SL (JIS)	68 ±5%	4.5	2.0	1.0	2.5	0.3 min.
GA342A1XGD820JW31L	AC250 (r.m.s.)	SL (JIS)	82 ±5%	4.5	2.0	1.0	2.5	0.3 min.
GA342QR7GD101KW01L	AC250 (r.m.s.)	X7R (EIA)	100 ±10%	4.5	2.0	1.5	2.5	0.3 min.
GA342QR7GD151KW01L	AC250 (r.m.s.)	X7R (EIA)	150 ±10%	4.5	2.0	1.5	2.5	0.3 min.
GA342QR7GD221KW01L	AC250 (r.m.s.)	X7R (EIA)	220 ±10%	4.5	2.0	1.5	2.5	0.3 min.
GA342QR7GD331KW01L	AC250 (r.m.s.)	X7R (EIA)	330 ±10%	4.5	2.0	1.5	2.5	0.3 min.
GA342QR7GD471KW01L	AC250 (r.m.s.)	X7R (EIA)	470 ±10%	4.5	2.0	1.5	2.5	0.3 min.
GA342QR7GD681KW01L	AC250 (r.m.s.)	X7R (EIA)	680 ±10%	4.5	2.0	1.5	2.5	0.3 min.
GA342QR7GD102KW01L	AC250 (r.m.s.)	X7R (EIA)	1000 ±10%	4.5	2.0	1.5	2.5	0.3 min.
GA342QR7GD152KW01L	AC250 (r.m.s.)	X7R (EIA)	1500 ±10%	4.5	2.0	1.5	2.5	0.3 min.
GA343QR7GD182KW01L	AC250 (r.m.s.)	X7R (EIA)	1800 ±10%	4.5	3.2	1.5	2.5	0.3 min.
GA343QR7GD222KW01L	AC250 (r.m.s.)	X7R (EIA)	2200 ±10%	4.5	3.2	1.5	2.5	0.3 min.
GA343DR7GD472KW01L	AC250 (r.m.s.)	X7R (EIA)	4700 ±10%	4.5	3.2	2.0	2.5	0.3 min.

片状独石陶瓷电容器



安全规格认证品 GF型 (IEC60384-14 Y2, X1/Y2级)

特点

1. 可用于符合IEC/EN60950及UL1950标准的机器。而且，GA352/355型可用于符合IEC/EN60065、UL1492、及UL6500标准的机器。
2. GF型可用作Y2级电容器。
3. 新型独石结构，体积小、静电容量高，能在高电压下工作。
4. 保证承受 + 125 。
5. 仅适用回流焊接。
6. 提供低型（厚度：最大1.5mm）。它们适用于薄型设备。

用途

1. 最适合无变压器的DAA调制解调器线路滤波器及耦合用。
2. 最适合信息设备线路滤波器用。
3. 最适合用作各种切换式电源的Y电容器或X电容器。（仅限GA352/355型）

请勿将这些产品用于汽车动力总成或安全设备，包括电动车和插入式混合动力车的充电器。
 只有产品指南上明确标有“车用”的产品才可用于诸如动力传动和安全设备等汽车应用。

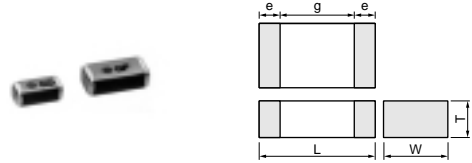

Part Number	Dimensions (mm)				
	L	W	T	e min.	g min.
GA342A	4.5 ±0.3	2.0 ±0.2	1.0 +0, -0.3	0.3	2.5
GA342D			2.0 ±0.2*		
GA342Q			1.5 +0, -0.3		
GA352Q	5.7 ±0.4	2.8 ±0.3	1.5 +0, -0.3		
GA355D			2.0 +0, -0.3		
GA355Q			1.5 +0, -0.3		

* GA342D1X : 2.0±0.3

安全规格认证情况

	Standard No.	Class	Status of Recognition		Rated Voltage
			Size : 4.5x2.0mm	Size : 5.7x2.8mm and over	
UL	UL1414	X1, Y2	—	◎	AC250V (r.m.s.)
	UL 60950-1	—	◎	—	
VDE	IEC 60384-14	X1, Y2	—	◎	(r.m.s.)
SEMKO	EN 60384-14	Y2	◎	◎	

Applications

Size	Switching power supplies	Communication network devices such as a modem
4.5x2.0mm	—	◎
5.7x2.8mm and over	◎	◎

品名	额定电压 (V)	温度特性代号 (规格)	静电容量 (pF)	长 L (mm)	宽 W (mm)	厚度 T (mm)	电极 g 最小 (mm)	电极 e (mm)
GA342D1XGF100JY02L	AC250 (r.m.s.)	SL (JIS)	10 ±5%	4.5	2.0	2.0	2.5	0.3 min.
GA342D1XGF120JY02L	AC250 (r.m.s.)	SL (JIS)	12 ±5%	4.5	2.0	2.0	2.5	0.3 min.
GA342D1XGF150JY02L	AC250 (r.m.s.)	SL (JIS)	15 ±5%	4.5	2.0	2.0	2.5	0.3 min.
GA342D1XGF180JY02L	AC250 (r.m.s.)	SL (JIS)	18 ±5%	4.5	2.0	2.0	2.5	0.3 min.
GA342D1XGF220JY02L	AC250 (r.m.s.)	SL (JIS)	22 ±5%	4.5	2.0	2.0	2.5	0.3 min.
GA342A1XGF270JW31L	AC250 (r.m.s.)	SL (JIS)	27 ±5%	4.5	2.0	1.0	2.5	0.3 min.
GA342A1XGF330JW31L	AC250 (r.m.s.)	SL (JIS)	33 ±5%	4.5	2.0	1.0	2.5	0.3 min.
GA342A1XGF390JW31L	AC250 (r.m.s.)	SL (JIS)	39 ±5%	4.5	2.0	1.0	2.5	0.3 min.
GA342A1XGF470JW31L	AC250 (r.m.s.)	SL (JIS)	47 ±5%	4.5	2.0	1.0	2.5	0.3 min.
GA342A1XGF560JW31L	AC250 (r.m.s.)	SL (JIS)	56 ±5%	4.5	2.0	1.0	2.5	0.3 min.
GA342A1XGF680JW31L	AC250 (r.m.s.)	SL (JIS)	68 ±5%	4.5	2.0	1.0	2.5	0.3 min.
GA342A1XGF820JW31L	AC250 (r.m.s.)	SL (JIS)	82 ±5%	4.5	2.0	1.0	2.5	0.3 min.
GA342QR7GF101KW01L	AC250 (r.m.s.)	X7R (EIA)	100 ±10%	4.5	2.0	1.5	2.5	0.3 min.
GA342QR7GF151KW01L	AC250 (r.m.s.)	X7R (EIA)	150 ±10%	4.5	2.0	1.5	2.5	0.3 min.
GA342DR7GF221KW02L	AC250 (r.m.s.)	X7R (EIA)	220 ±10%	4.5	2.0	2.0	2.5	0.3 min.
GA342DR7GF331KW02L	AC250 (r.m.s.)	X7R (EIA)	330 ±10%	4.5	2.0	2.0	2.5	0.3 min.
GA342QR7GF471KW01L	AC250 (r.m.s.)	X7R (EIA)	470 ±10%	4.5	2.0	1.5	2.5	0.3 min.
GA352QR7GF471KW01L	AC250 (r.m.s.)	X7R (EIA)	470 ±10%	5.7	2.8	1.5	4.0	0.3 min.
GA342QR7GF681KW01L	AC250 (r.m.s.)	X7R (EIA)	680 ±10%	4.5	2.0	1.5	2.5	0.3 min.
GA352QR7GF681KW01L	AC250 (r.m.s.)	X7R (EIA)	680 ±10%	5.7	2.8	1.5	4.0	0.3 min.
GA342DR7GF102KW02L	AC250 (r.m.s.)	X7R (EIA)	1000 ±10%	4.5	2.0	2.0	2.5	0.3 min.
GA352QR7GF102KW01L	AC250 (r.m.s.)	X7R (EIA)	1000 ±10%	5.7	2.8	1.5	4.0	0.3 min.
GA352QR7GF152KW01L	AC250 (r.m.s.)	X7R (EIA)	1500 ±10%	5.7	2.8	1.5	4.0	0.3 min.

接下页。

☐ 接上页。

品名	额定电压 (V)	温度特性代号 (规格)	静电容量 (pF)	长 L (mm)	宽 W (mm)	厚度 T (mm)	电极 g 最小 (mm)	电极 e (mm)
GA355QR7GF182KW01L	AC250 (r.m.s.)	X7R (EIA)	1800 ±10%	5.7	5.0	1.5	4.0	0.3 min.
GA355QR7GF222KW01L	AC250 (r.m.s.)	X7R (EIA)	2200 ±10%	5.7	5.0	1.5	4.0	0.3 min.
GA355QR7GF332KW01L	AC250 (r.m.s.)	X7R (EIA)	3300 ±10%	5.7	5.0	1.5	4.0	0.3 min.
GA355DR7GF472KW01L	AC250 (r.m.s.)	X7R (EIA)	4700 ±10%	5.7	5.0	2.0	4.0	0.3 min.

www.tocosc.com

片状独石陶瓷电容器



安全规格认证品 GB型 (IEC60384-14 X2级)

特点

1. GB型可用作X2级电容器。
2. 交流线路用片状独石陶瓷电容器 (经认证符合安全标准)。
3. 新型独石结构，体积小、静电容量高，能在高电压下工作。
4. 与引线型电容器相比，本新型电容器已变得极小、极薄，其体积不超过以前的1/10，高度不超过1/4。
5. 保证承受 + 125 。
6. 仅适用回流焊接。

用途

最适合用作各种切换式电源的X电容器

请勿将这些产品用于汽车动力总成或安全设备，包括电动车和插入式混合动力车的充电器。

只有产品指南上明确标有“车用”的产品才可用于诸如动力传动和安全设备等汽车应用。

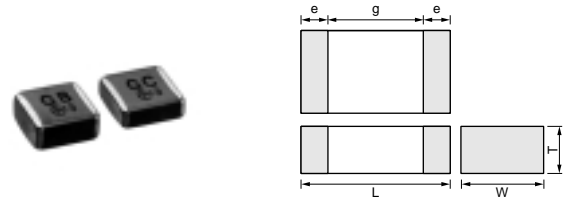



Part Number	Dimensions (mm)				
	L	W	T	e min.	g min.
GA355Q	5.7 ±0.4	5.0 ±0.4	1.5 +0,-0.3	0.3	3.0
GA355D			2.0 +0,-0.3		
GA355E			2.5 +0,-0.3		
GA355X			2.9 +0,-0.4		

安全规格认证情况

	Standard No.	Class	Rated Voltage
VDE	IEC 60384-14 EN 60384-14	X2	AC250V (r.m.s.)
SEMKO			
ESTI			

品名	额定电压 (V)	温度特性代号 (规格)	静电容量 (pF)	长 L (mm)	宽 W (mm)	厚度 T (mm)	电极 g 最小 (mm)	电极 e (mm)
GA355QR7GB103KW01L	AC250 (r.m.s.)	X7R (EIA)	10000 ±10%	5.7	5.0	1.5	3.0	0.3 min.
GA355QR7GB153KW01L	AC250 (r.m.s.)	X7R (EIA)	15000 ±10%	5.7	5.0	1.5	3.0	0.3 min.
GA355DR7GB223KW01L	AC250 (r.m.s.)	X7R (EIA)	22000 ±10%	5.7	5.0	2.0	3.0	0.3 min.
GA355ER7GB333KW01L	AC250 (r.m.s.)	X7R (EIA)	33000 ±10%	5.7	5.0	2.5	3.0	0.3 min.
GA355ER7GB473KW01L	AC250 (r.m.s.)	X7R (EIA)	47000 ±10%	5.7	5.0	2.5	3.0	0.3 min.
GA355XR7GB563KW06L	AC250 (r.m.s.)	X7R (EIA)	56000 ±10%	5.7	5.0	2.9	3.0	0.3 min.

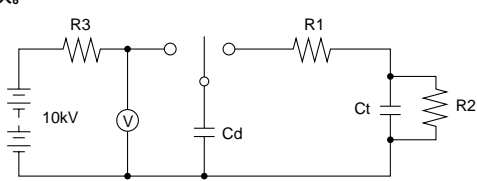
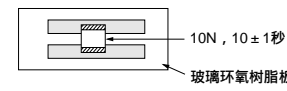
GA3系列规格和测试方法

编号	项目	特性	测试方法																				
1	动作温度范围	- 55至 + 125°C	-																				
2	外观	无缺陷或异常	目视检查																				
3	尺寸	在规定尺寸范围内	使用游标卡尺																				
4	介电强度	无缺陷或异常	在端子间施加表中的电压60 ± 1秒时不应观察到任何故障，并且充电/放电电流低于50mA。 <table border="1" style="margin-left: auto; margin-right: auto;"> <thead> <tr> <th colspan="2">测试电压</th> </tr> </thead> <tbody> <tr> <td>GB型</td> <td>DC1075V</td> </tr> <tr> <td>GC/GD/GF型</td> <td>AC1500V (r.m.s.)</td> </tr> </tbody> </table>	测试电压		GB型	DC1075V	GC/GD/GF型	AC1500V (r.m.s.)														
测试电压																							
GB型	DC1075V																						
GC/GD/GF型	AC1500V (r.m.s.)																						
5	冲激电压 (用于: GD/GF型)	电容器中未发生自愈的故障或闪络。	进行10次交替极性脉冲。 (每个极性各5次) 脉冲间隔为60秒。 外加电压: 零到峰值2.5kV																				
6	绝缘电阻 (I.R.)	大于6,000MΩ	绝缘电阻应在DC500 ± 50V条件下、在充电开始60 ± 5秒内测量。																				
7	静电容容量	在规定偏差范围内																					
8	散逸因数 (D.F.) Q	<table border="1" style="margin-left: auto; margin-right: auto;"> <thead> <tr> <th>特性</th> <th>规格</th> </tr> </thead> <tbody> <tr> <td>X7R</td> <td>D.F. ≤ 0.025</td> </tr> <tr> <td>SL</td> <td>Q ≥ 400 + 20C*² (C < 30pF) Q ≥ 1000 (C ≥ 30pF)</td> </tr> </tbody> </table>	特性	规格	X7R	D.F. ≤ 0.025	SL	Q ≥ 400 + 20C* ² (C < 30pF) Q ≥ 1000 (C ≥ 30pF)	静电容容量/Q值/D.F.值应在1 ± 0.2kHz的频率 (SL特性: 1 ± 0.2MHz) 及AC1 ± 0.2V (r.m.s.) 的电压条件下进行测量。														
特性	规格																						
X7R	D.F. ≤ 0.025																						
SL	Q ≥ 400 + 20C* ² (C < 30pF) Q ≥ 1000 (C ≥ 30pF)																						
9	静电容容量温度特性	<table border="1" style="margin-left: auto; margin-right: auto;"> <thead> <tr> <th>特性</th> <th>静电容容量变化</th> </tr> </thead> <tbody> <tr> <td>X7R</td> <td>在 ± 15% 范围内</td> </tr> </tbody> </table> <p>在 - 55至 + 125°C范围保证温度特性</p> <table border="1" style="margin-left: auto; margin-right: auto;"> <thead> <tr> <th>特性</th> <th>温度系数</th> </tr> </thead> <tbody> <tr> <td>SL</td> <td>+ 350至 - 1000ppm/°C</td> </tr> </tbody> </table> <p>在 + 20至 + 85°C范围保证温度特性</p>	特性	静电容容量变化	X7R	在 ± 15% 范围内	特性	温度系数	SL	+ 350至 - 1000ppm/°C	<p>静电容容量应在表中列出的各温度阶段进行测量。</p> <table border="1" style="margin-left: auto; margin-right: auto;"> <thead> <tr> <th>阶段</th> <th>温度 (°C)</th> </tr> </thead> <tbody> <tr> <td>1</td> <td>25 ± 2 (SL特性20 ± 2)</td> </tr> <tr> <td>2</td> <td>最低工作温度 ± 3</td> </tr> <tr> <td>3</td> <td>25 ± 2 (SL特性20 ± 2)</td> </tr> <tr> <td>4</td> <td>最高工作温度 ± 2</td> </tr> <tr> <td>5</td> <td>25 ± 2 (SL特性20 ± 2)</td> </tr> </tbody> </table> <p>SL特性: 应在阶段3和阶段4之间在85°C条件下测量静电容容量。 • X7R特性预处理 进行150 + 0 - 10°C热处理60 ± 5分钟，然后在室内条件*1下放置24 ± 2小时。</p>	阶段	温度 (°C)	1	25 ± 2 (SL特性20 ± 2)	2	最低工作温度 ± 3	3	25 ± 2 (SL特性20 ± 2)	4	最高工作温度 ± 2	5	25 ± 2 (SL特性20 ± 2)
特性	静电容容量变化																						
X7R	在 ± 15% 范围内																						
特性	温度系数																						
SL	+ 350至 - 1000ppm/°C																						
阶段	温度 (°C)																						
1	25 ± 2 (SL特性20 ± 2)																						
2	最低工作温度 ± 3																						
3	25 ± 2 (SL特性20 ± 2)																						
4	最高工作温度 ± 2																						
5	25 ± 2 (SL特性20 ± 2)																						
10	放电测试 (用于: GC型)	<p>外观 无缺陷或异常</p> <p>绝缘电阻 大于1,000MΩ</p> <p>介电强度 按照第4项</p>	<p>如图所示，按规定的直流电压充电的电容器 (Cd) 以5秒为间隔放电50次。</p>  <p>Ct: 被测电容器 Cd: 0.001μF R1: 1,000Ω R2: 100MΩ R3: 浪涌电阻</p>																				
11	端子结合强度	不应出现端子脱落或其它缺陷。	<p>将电容器焊接在图1中所示的测试夹具 (玻璃环氧树脂板) 上。然后沿箭头方向施加10N的力。焊接应使用回流焊接方法进行，而且应谨慎作业，以使焊接均匀且不会由于热冲击产生缺陷。</p>  <p>图1</p>																				
12	振荡电阻	<p>外观 无缺陷或异常</p> <p>静电容容量 在规定偏差范围内</p> <table border="1" style="margin-left: auto; margin-right: auto;"> <thead> <tr> <th>特性</th> <th>规格</th> </tr> </thead> <tbody> <tr> <td>X7R</td> <td>D.F. ≤ 0.025</td> </tr> <tr> <td>SL</td> <td>Q ≥ 400 + 20C*² (C < 30pF) Q ≥ 1000 (C ≥ 30pF)</td> </tr> </tbody> </table>	特性	规格	X7R	D.F. ≤ 0.025	SL	Q ≥ 400 + 20C* ² (C < 30pF) Q ≥ 1000 (C ≥ 30pF)	<p>将电容器焊接在测试夹具 (玻璃环氧树脂板) 上。电容器应进行简谐运动，其总幅值为1.5mm，频率在近似10至55Hz之间均匀变化。频率范围 (从10至55Hz再返回10Hz) 应在约1分钟内完成。振动应在3个相互垂直方向各进行2小时 (总计6小时)。</p> 														
特性	规格																						
X7R	D.F. ≤ 0.025																						
SL	Q ≥ 400 + 20C* ² (C < 30pF) Q ≥ 1000 (C ≥ 30pF)																						

*1 "室内条件" 温度: 15至35°C, 相对湿度: 45至75%, 大气压: 86至106kPa

*2 "C" 表示标称静电容容量值 (pF)。

GA3系列规格和测试方法

☐ 接上页。

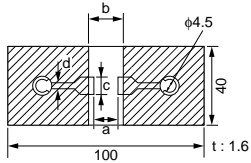
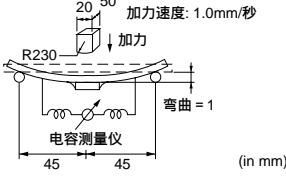
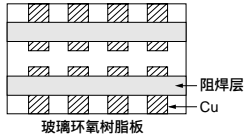
编号	项目	特性	测试方法																							
13	弯曲强度	不应出现裂缝或明显缺陷。	将电容器焊接在图2中所示的测试夹具(玻璃环氧树脂板)上。 然后在图3所示的方向加力。 焊接应使用回流焊接方法进行，而且应谨慎作业，以使焊接均匀且不会由于热冲击产生缺陷。																							
		 <table border="1" data-bbox="363 474 874 627"> <thead> <tr> <th rowspan="2">长×宽 (mm)</th> <th colspan="4">尺寸 (mm)</th> </tr> <tr> <th>a</th> <th>b</th> <th>c</th> <th>d</th> </tr> </thead> <tbody> <tr> <td>4.5×2.0</td> <td>3.5</td> <td>7.0</td> <td>2.4</td> <td rowspan="4">1.0</td> </tr> <tr> <td>4.5×3.2</td> <td>3.5</td> <td>7.0</td> <td>3.7</td> </tr> <tr> <td>5.7×2.8</td> <td>4.5</td> <td>8.0</td> <td>3.2</td> </tr> <tr> <td>5.7×5.0</td> <td>4.5</td> <td>8.0</td> <td>5.6</td> </tr> </tbody> </table> <p style="text-align: center;">图2</p>		长×宽 (mm)	尺寸 (mm)				a	b	c	d	4.5×2.0	3.5	7.0	2.4	1.0	4.5×3.2	3.5	7.0	3.7	5.7×2.8	4.5	8.0	3.2	5.7×5.0
长×宽 (mm)	尺寸 (mm)																									
	a	b	c	d																						
4.5×2.0	3.5	7.0	2.4	1.0																						
4.5×3.2	3.5	7.0	3.7																							
5.7×2.8	4.5	8.0	3.2																							
5.7×5.0	4.5	8.0	5.6																							
14	端子可焊性	75%端子需均匀且连续焊接。	将电容器浸在乙醇(JIS-K-8101)和松香(JIS-K-5902)(松香占25%的重量)溶液中。 浸泡在焊锡溶液 2 ± 0.5 秒。 浸泡速度: 25 ± 2.5 mm/秒 焊锡温度: $245 \pm 5^\circ\text{C}$ 无铅焊料(Sn-3.0Ag-0.5Cu) $235 \pm 5^\circ\text{C}$ H60A或H63A 共晶锡																							
			 <p style="text-align: center;">图3</p>																							
15	耐焊热性	外观	无明显缺陷																							
		静电容量变化	<table border="1"> <thead> <tr> <th>特性</th> <th>静电容量变化</th> </tr> </thead> <tbody> <tr> <td>X7R</td> <td>在$\pm 10\%$范围内</td> </tr> <tr> <td>SL</td> <td>在$\pm 2.5\%$或$\pm 0.25\text{pF}$(以较大者为准)范围内</td> </tr> </tbody> </table>	特性	静电容量变化	X7R	在 $\pm 10\%$ 范围内	SL	在 $\pm 2.5\%$ 或 $\pm 0.25\text{pF}$ (以较大者为准)范围内																	
		特性	静电容量变化																							
		X7R	在 $\pm 10\%$ 范围内																							
SL	在 $\pm 2.5\%$ 或 $\pm 0.25\text{pF}$ (以较大者为准)范围内																									
绝缘电阻	大于1,000MΩ																									
介电强度	按照第4项																									
			按下表预热电容器。将电容器浸泡在 $260 \pm 5^\circ\text{C}$ 的共晶锡溶液 10 ± 1 秒。 在*1室内条件下放置 24 ± 2 小时，然后进行测量。 • 浸泡速度: 25 ± 2.5 mm/秒 • X7R特性预处理 进行 $150 + 0/- 10^\circ\text{C}$ 热处理 60 ± 5 分钟，然后在*1室内条件下放置 24 ± 2 小时。																							
			*预热 <table border="1" data-bbox="933 1064 1444 1142"> <thead> <tr> <th>阶段</th> <th>温度</th> <th>时间</th> </tr> </thead> <tbody> <tr> <td>1</td> <td>100°C至120°C</td> <td>1分钟</td> </tr> <tr> <td>2</td> <td>170°C至200°C</td> <td>1分钟</td> </tr> </tbody> </table>	阶段	温度	时间	1	100°C 至 120°C	1分钟	2	170°C 至 200°C	1分钟														
阶段	温度	时间																								
1	100°C 至 120°C	1分钟																								
2	170°C 至 200°C	1分钟																								
16	温度周期	外观	无明显缺陷																							
		静电容量变化	<table border="1"> <thead> <tr> <th>特性</th> <th>静电容量变化</th> </tr> </thead> <tbody> <tr> <td>X7R</td> <td>在$\pm 15\%$范围内</td> </tr> <tr> <td>SL</td> <td>在$\pm 2.5\%$或$\pm 0.25\text{pF}$(以较大者为准)范围内</td> </tr> </tbody> </table>	特性	静电容量变化	X7R	在 $\pm 15\%$ 范围内	SL	在 $\pm 2.5\%$ 或 $\pm 0.25\text{pF}$ (以较大者为准)范围内																	
		特性	静电容量变化																							
		X7R	在 $\pm 15\%$ 范围内																							
		SL	在 $\pm 2.5\%$ 或 $\pm 0.25\text{pF}$ (以较大者为准)范围内																							
		D.F. Q	<table border="1"> <thead> <tr> <th>特性</th> <th>规格</th> </tr> </thead> <tbody> <tr> <td>X7R</td> <td>D.F. ≤ 0.05</td> </tr> <tr> <td>SL</td> <td>$Q \geq 400 + 20C^{*2}$ ($C < 30\text{pF}$) $Q \geq 1000$ ($C \geq 30\text{pF}$)</td> </tr> </tbody> </table>	特性	规格	X7R	D.F. ≤ 0.05	SL	$Q \geq 400 + 20C^{*2}$ ($C < 30\text{pF}$) $Q \geq 1000$ ($C \geq 30\text{pF}$)																	
特性	规格																									
X7R	D.F. ≤ 0.05																									
SL	$Q \geq 400 + 20C^{*2}$ ($C < 30\text{pF}$) $Q \geq 1000$ ($C \geq 30\text{pF}$)																									
绝缘电阻	大于3,000MΩ																									
介电强度	按照第4项																									
			将电容器固定在图4中所示的支撑夹具(玻璃环氧树脂板)上。 按照下表中列出的4种热处理方法执行5个周期。 在*1室内条件下放置 24 ± 2 小时，然后进行测量。 <table border="1" data-bbox="933 1243 1444 1377"> <thead> <tr> <th>阶段</th> <th>温度(°C)</th> <th>时间(分钟)</th> </tr> </thead> <tbody> <tr> <td>1</td> <td>最低动作温度± 3</td> <td>30 ± 3</td> </tr> <tr> <td>2</td> <td>常温</td> <td>2至3</td> </tr> <tr> <td>3</td> <td>最高动作温度± 2</td> <td>30 ± 3</td> </tr> <tr> <td>4</td> <td>常温</td> <td>2至3</td> </tr> </tbody> </table>	阶段	温度(°C)	时间(分钟)	1	最低动作温度 ± 3	30 ± 3	2	常温	2至3	3	最高动作温度 ± 2	30 ± 3	4	常温	2至3								
阶段	温度(°C)	时间(分钟)																								
1	最低动作温度 ± 3	30 ± 3																								
2	常温	2至3																								
3	最高动作温度 ± 2	30 ± 3																								
4	常温	2至3																								
			• X7R特性预处理 进行 $150 + 0/- 10^\circ\text{C}$ 热处理 60 ± 5 分钟，然后在*1室内条件下放置 24 ± 2 小时。																							
			 <p style="text-align: center;">图4</p>																							
17	湿度(稳态)	外观	无明显缺陷																							
		静电容量变化	<table border="1"> <thead> <tr> <th>特性</th> <th>静电容量变化</th> </tr> </thead> <tbody> <tr> <td>X7R</td> <td>在$\pm 15\%$范围内</td> </tr> <tr> <td>SL</td> <td>在$\pm 5.0\%$或$\pm 0.5\text{pF}$(以较大者为准)范围内</td> </tr> </tbody> </table>	特性	静电容量变化	X7R	在 $\pm 15\%$ 范围内	SL	在 $\pm 5.0\%$ 或 $\pm 0.5\text{pF}$ (以较大者为准)范围内																	
		特性	静电容量变化																							
		X7R	在 $\pm 15\%$ 范围内																							
		SL	在 $\pm 5.0\%$ 或 $\pm 0.5\text{pF}$ (以较大者为准)范围内																							
D.F. Q	<table border="1"> <thead> <tr> <th>特性</th> <th>规格</th> </tr> </thead> <tbody> <tr> <td>X7R</td> <td>D.F. ≤ 0.05</td> </tr> <tr> <td>SL</td> <td>$Q \geq 275 + 5/2C^{*2}$ ($C < 30\text{pF}$) $Q \geq 350$ ($C \geq 30\text{pF}$)</td> </tr> </tbody> </table>	特性	规格	X7R	D.F. ≤ 0.05	SL	$Q \geq 275 + 5/2C^{*2}$ ($C < 30\text{pF}$) $Q \geq 350$ ($C \geq 30\text{pF}$)																			
特性	规格																									
X7R	D.F. ≤ 0.05																									
SL	$Q \geq 275 + 5/2C^{*2}$ ($C < 30\text{pF}$) $Q \geq 350$ ($C \geq 30\text{pF}$)																									
绝缘电阻	大于3,000MΩ																									
介电强度	按照第4项																									
			这项测试之前,已进行了下列项目测试。 • 编号11 端子结合强度(施加5N的力) • 编号13 电路板耐弯曲性能																							
			将电容器在 $40 \pm 2^\circ\text{C}$ 及90至95%相对湿度条件下放置 $500 + 24/- 0$ 小时。 撤到*1室内条件下放置 24 ± 2 小时，然后进行测量。 • X7R特性预处理 进行 $150 + 0/- 10^\circ\text{C}$ 热处理 60 ± 5 分钟，然后在*1室内条件下放置 24 ± 2 小时。																							

*1 "室内条件" 温度: 15至 35°C , 相对湿度: 45至75%, 大气压: 86至106kPa

*2 "C" 表示标称静电容量值(pF)。

☐ 接下页。

GA3系列规格和测试方法

☞ 接上页。

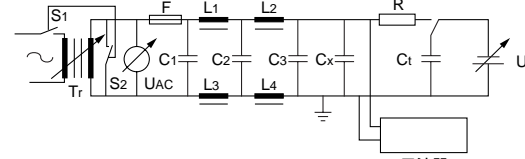
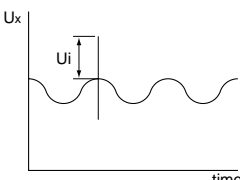
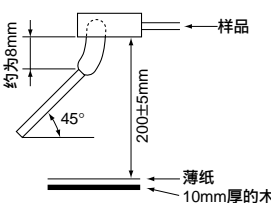
编号	项目	特性	测试方法						
18	寿命	外观	无明显缺陷						
		静电容量变化	特性	静电容量变化					
			X7R	在 ± 20% 范围内					
		D.F. Q	特性	规格					
			X7R	D.F. ≤ 0.05					
绝缘电阻	大于 3,000MΩ								
介电强度	按照第4项								
19	湿度负荷	外观	无明显缺陷						
		静电容量变化	特性	静电容量变化					
			X7R	在 ± 15% 范围内					
		D.F. Q	特性	规格					
			X7R	D.F. ≤ 0.05					
绝缘电阻	大于 3,000MΩ								
介电强度	按照第4项								
20	主动可燃性	cheesecloth (粗绵布) 不燃烧。	<p>电容器因个别用1到2层cheesecloth (粗绵布) 包装。在电容器施加20次放电。各次放电的间隔为5秒。最后的放电后，U_{AC}应保持通电2分钟。</p>  <p>示波器</p> <p>C_{1,2} : 1μF ± 10% C₃ : 0.033μF ± 5% 10kV L₁至₄: 1.5mH ± 20% 16A 杆状扼流 C_t : 3μF ± 5% 10kV R : 100Ω ± 2% C_x : 电容器 (测试对象) U_{AC} : U_R ± 5% F : 保险丝 额定电流 16A U_R : 额定电压 U_t : 在C_t施加的电压</p>  <table border="1" data-bbox="1181 1590 1420 1680"> <thead> <tr> <th>型号</th> <th>U_i</th> </tr> </thead> <tbody> <tr> <td>GB, GD</td> <td>2.5kV</td> </tr> <tr> <td>GC, GF</td> <td>5kV</td> </tr> </tbody> </table>	型号	U _i	GB, GD	2.5kV	GC, GF	5kV
型号	U _i								
GB, GD	2.5kV								
GC, GF	5kV								
21	被动可燃性	燃烧时间不超过30秒。薄纸不燃烧。	<p>测试的电容器应在燃烧效果最佳的位置。每个样品应一次性燃烧。 燃烧时间：30秒</p>  <p>火焰尺寸: 12 ± 1mm 喷烧器 : 35mm长 内径 0.5 ± 0.1mm 外径 最大0.9mm 气体 : 纯度95%以上的丁烷</p>						

*1 "室内条件" 温度: 15至35°C, 相对湿度: 45至75%, 大气压: 86至106kPa

*2 "C" 表示标称静电容量值 (pF)。

GRM/GR4/GR7/GA2/GA3系列数据 (典例)

■ 静电容量 - 温度特性

C0G/U2J/SL特性

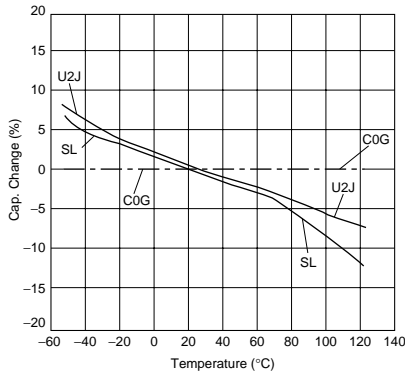

X7R特性

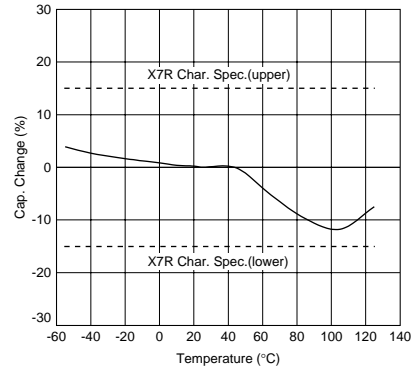

GR4系列

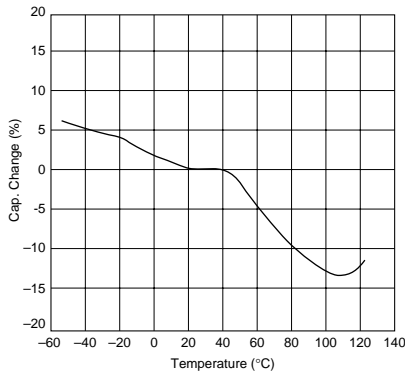

■ 阻抗 - 频率特性

GRM系列 (C0G特性 630V)

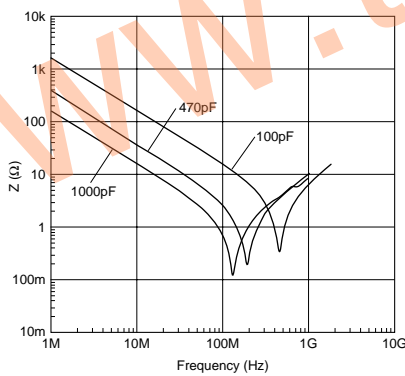

GRM系列 (X7R特性 250V)

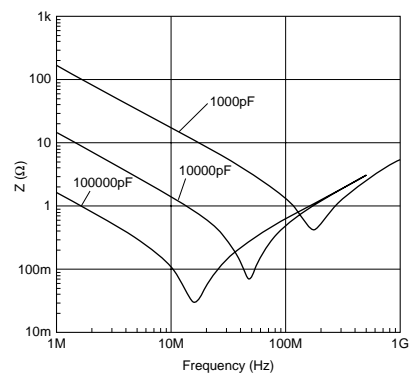

接下页。

GRM/GR4/GR7/GA2/GA3系列数据 (典例)

接上页

■ 阻抗 - 频率特性

GRM系列 (X7R特性 630V)

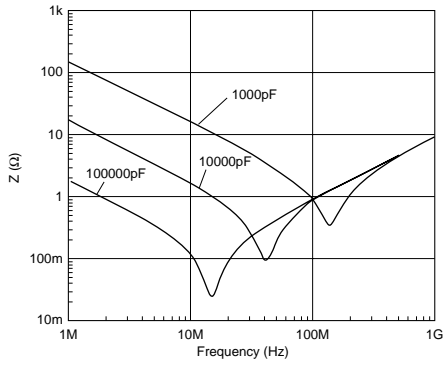

GR4系列

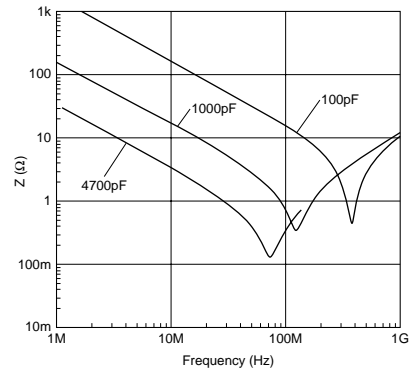

GR7系列

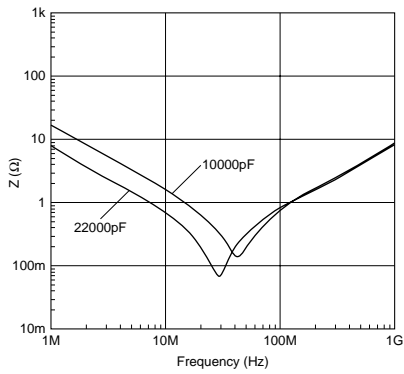

GA2系列

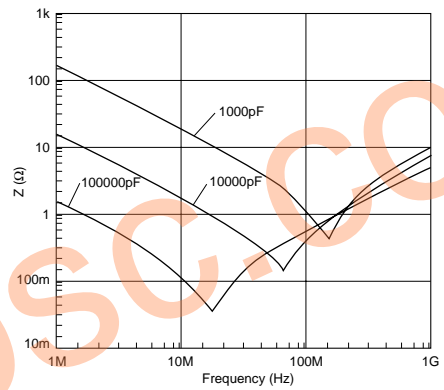

GA3系列 (GD型)

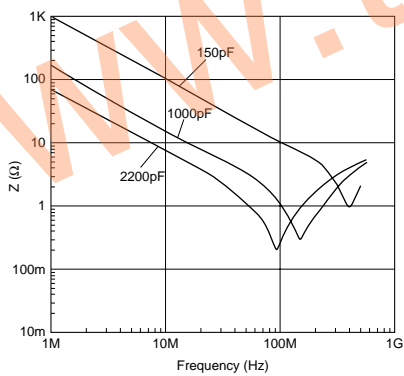

GA3系列 (GF型)

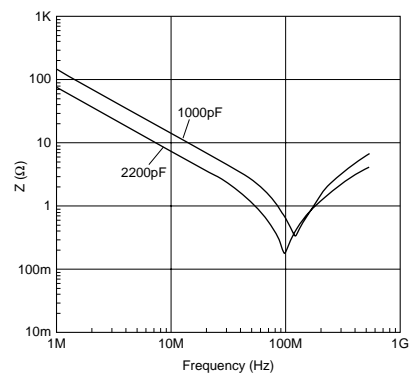

接下页

GRM/GR4/GR7/GA2/GA3系列数据 (典例)

接上页

■ 阻抗 - 频率特性

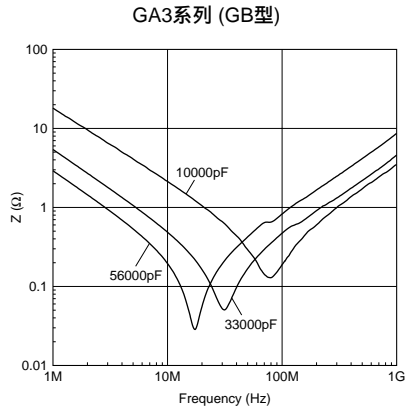

■ 静电容量 - 交流电压特性

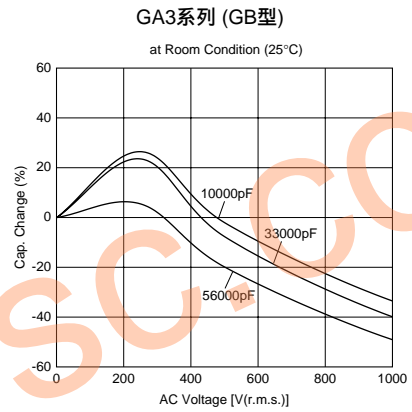
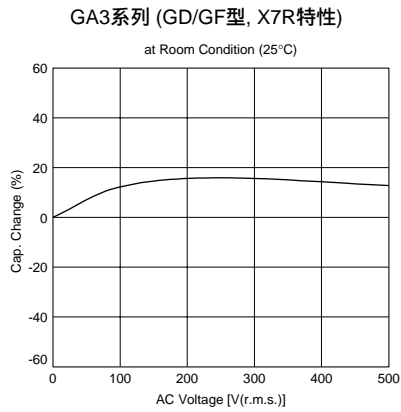

www.tococsc.com

包装

编带是标准的包装方法。

最少订购数量指南

品名		尺寸 (mm)			数量 (件)	
					φ180mm卷盘	
		L	W	T	纸带	压纹带
中高压	GRM18	1.6	0.8	0.8	4,000	-
	GRM21	2.0	1.25	1.0	4,000	-
				1.25	-	3,000
	GRM31/GR731	3.2	1.6	1.0	4,000	-
				1.25	-	3,000
				1.6	-	2,000
	GRM32	3.2	2.5	1.0	4,000	-
				1.25	-	3,000
				1.5	-	2,000
	GRM42/GR442	4.5	2.0	1.0	-	3,000
1.5				-	2,000	
2.0				-	2,000	
GRM43/GR443	4.5	3.2	1.5	-	1,000	
			2.0	-	1,000	
			2.5	-	500	
GRM55/GR455	5.7	5.0	2.0	-	1,000	
AC250V	GA242	4.5	2.0	1.5	-	2,000
	GA243	4.5	3.2	1.5	-	1,000
				2.0	-	1,000
GA255	5.7	5.0	2.0	-	1,000	
安全规格认证	GA342	4.5	2.0	1.0	-	3,000
				1.5	-	2,000
				2.0	-	2,000
	GA343	4.5	3.2	1.5	-	1,000
				2.0	-	1,000
	GA352	5.7	2.8	1.5	-	1,000
				2.0	-	1,000
				2.5	-	500
GA355	5.7	5.0	2.7	-	500	
			2.9	-	500	

编带包装

(1) 编带外观

压纹带

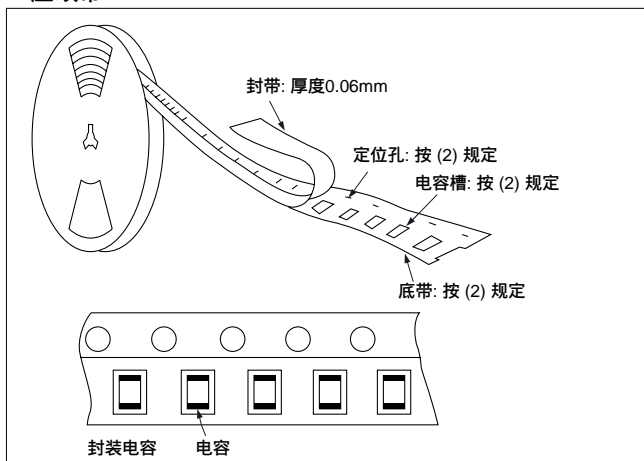

纸带

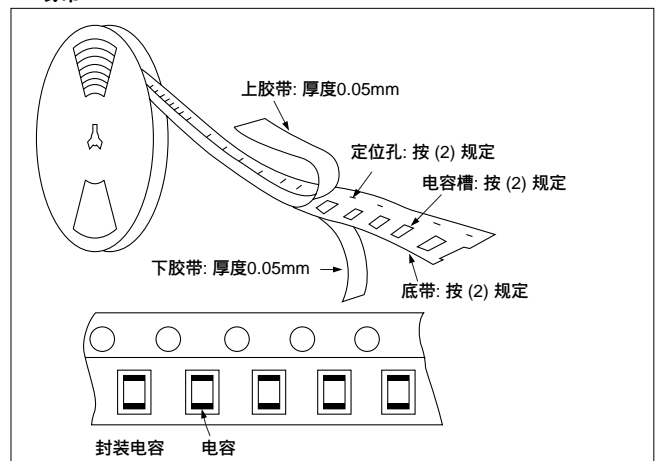

接下页。 ↗

包装

接上页。

(2) 编带尺寸
压纹带

8mm宽，4mm间距编带

品名	A*	B*
GRM21 (T≥1.25mm)	1.45	2.25
GRM31/GR731 (T≥1.25mm)	2.0	3.6
GRM32 (T≥1.25mm)	2.9	3.6

*标称值

12mm宽，8mm/4mm间距编带

品名	A*	B*
GRM42/GR442/GA242/GA342	2.5	5.1
GRM43/GR443/GA243/GA343	3.6	4.9
GA352	3.2	6.1
GRM55/GR455/GA255/GA355	5.4	6.1

*1 GRM42/GR442/GA242/GA342时4.0±0.1mm
*标称值

(in mm)

纸带

8mm宽，4mm间距编带

品名	A*	B*
GRM18	1.05	1.85
GRM21 (T=1.0mm)	1.45	2.25
GRM31/GR731 (T=1.0mm)	2.0	3.6
GRM32 (T=1.0mm)	2.9	3.6

*标称值
(in mm)

(3) 卷盘尺寸

(in mm)

接下页。

包装

接上页。

(4) 编带方法

电容器编带按顺时针方向缠绕。编带向您拉出时，定位孔位于右侧。

部分引导带及部分空白带应如右图所示贴在编带末端。上胶带或封带和底带至少有5个脚距的部分不能贴在编带末端。

短缺的电容器在每个卷盘中0.1%以内或不能超过1件(以较大者为准)，而且不能连续发生。

上胶带或封带和下胶带不应超出编带边缘，而且不能覆盖定位孔。

定位孔累计偏差，以10个脚距计： $\pm 0.3\text{mm}$

剥离力：如右图所示方向为0.1至0.6N。

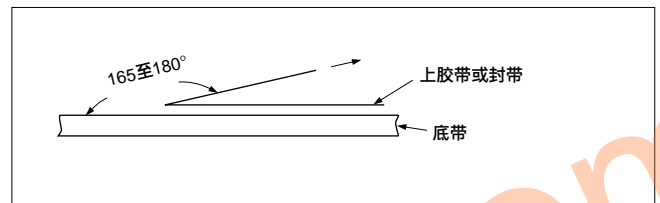
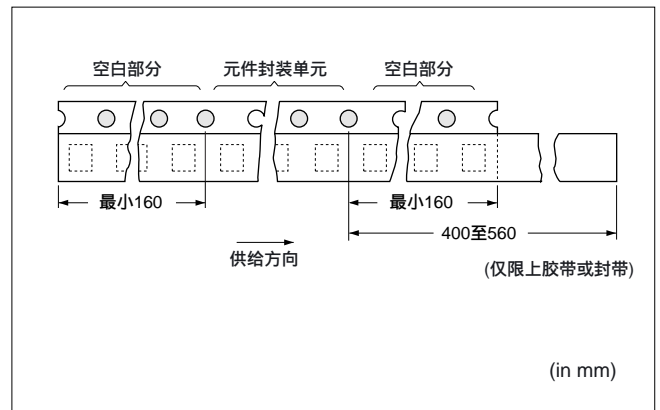

www.tocosc.com



■ 保管与使用条件

使用与保管环境

请勿将电容器存放在腐蚀性气体中，尤其是存在氯气、硫气、酸、碱、盐等的场所。同时应防潮。在对本产品进行清洗、覆膜或封膜前，请先在指定设备上测试经清洗、覆膜或封膜的产品性能，以确定上述过程不会影响产品质量。电容器应存放在温度及相对湿度分别不超出5至40 及20至70%范围的场所。

请在交货后6个月内使用电容器。

超过6个月时应检查其可焊性。

使用本产品时如忽略上述警告事项，则在严重情况下可能导致短路，并引起冒烟或局部离散。

■ 使用方面

1. 振动与冲击

使用时请勿使电容器受到过度冲击或振动。

2. 请勿直接触摸片状电容器，尤其是陶瓷部分。手上留下的残余物可能会造成短路。

使用本产品时如忽略上述警告事项，则在严重情况下可能导致短路，并引起冒烟或局部离散。

www.tocosc.com

警告

警告 (额定值)

1. 动作电压

在交流电路或纹波电流电路中使用直流额定电压电容器时，请务必将外加电压的Vp-p值或包含直流偏置电压的Vo-p值维持在额定电压范围内。

若向电路施加电压，开始或停止时可能会因谐振或切换产生暂时的异常电压。请务必使用额定电压范围包含这些异常电压的电容器。

当额定电压为直流电压的电容器用于商业电源的输入电路(AC滤波器)时，因考虑每台设备在耐电压或耐脉冲方面的各种限制规定，请确保使用安全认证型电容器。

电压	直流电压	直流 + 交流电压	交流电压	冲激电压 (1)	冲激电压 (2)
位置测量					

2. 高频电压条件下的工作温度、自生热和负荷减低

电容器的表面温度应保持在^其额定动作温度范围的上限以下。务必考虑到电容器自身发出的热量。电容器在高频电流、冲激电流等中使用可能会因介电损耗发出自生热。

(1) X7R特性时

外加电压应使自生热等负荷在25°C周围温度条件下不超过20°C范围。测量时应使用ø0.1mm小热容量(K)的热电偶，而且电容器不应受到其它元件的散热或周围温度波动影响。过热可能会导致电容器特性及可靠性下降。(切勿在冷却风扇运转时进行测量。否则无法确保测量数据的精确性)

接下页。



接上页。

(2) C0G, U2J特性时

由于低损耗电容器的低自热特性，这些电容器的允许功率一般比X7R特性电容器高很多。

当施加了引起电容器产生20°C自热的高频电压时，将超过电容器的允许功率。

外加的正弦波电压频率应小于500kHz (额定电压为DC3.15kV时小于100kHz)。外加电压应小于下图所示的值。

如果是包含谐波频率的非正弦波，请向村田制作所咨询。过热可能会导致电容器特性及可靠性下降 (切勿在冷却风扇运转时进行测量。否则无法确保测量数据的准确性)。

<C0G特性，额定电压:DC3.15kV>

小于22pF的电容器可应用于小于 / 等于100kHz，峰间最大值为4.0kV的条件，仅用于LCD背光灯反相电路中的镇流器或者谐振器。

<电容器选择工具>

我们也提供免费的软件 "村田中高压电容器选择工具(*)"，他将按照电压波形协助您选择合适的电容器。

该软件可从村田公司网站下载。

(http://www.murata.com/designlib/mmcsv_e.html).

通过输入电容值和施加在特定电容器系列上的电压波形，该软件将会计算电容器的功率消耗，并且列出合适的电容器 (非正弦波也是可以的)。

*截止2006年7月，对象系列如下。

- 温度特性C0G, U2J

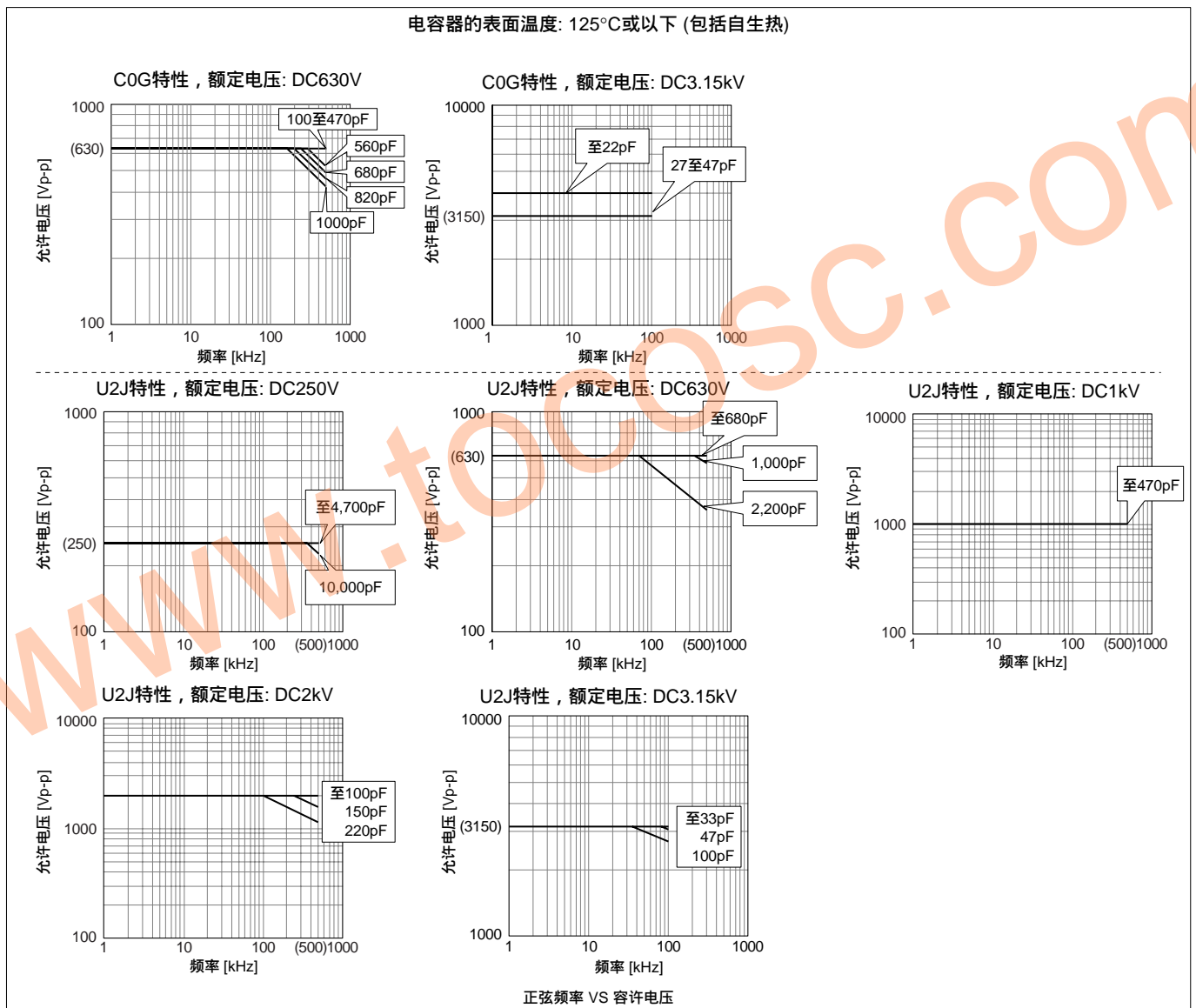

接下页。

警告

接上页。

3. 自动防故障

电容器失效可能会导致短路。务必在本产品上适当提供例如熔丝等自动防故障功能元件，这有助于消除可能发生的电击、火灾、或冒烟等。

如果在交流输入线路与接地之间使用电容器(旁通电容器)，请考虑在每条交流线路上使用熔丝，以防发生事故，例如短路。

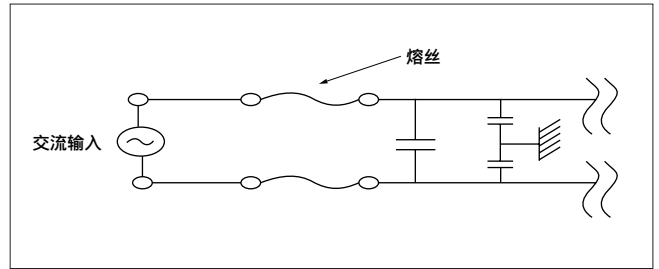

4. 交流耐电压的测试条件

(1) 测试设备

交流耐电压的测试所使用的设备应能产生与50/60Hz相似的正弦波。

如果施加变形的正弦波或超过规定电压值的过载电压，则可能会导致故障。

(2) 电压外加方法

电容器的引线或端子应与耐电压测试设备的输出端连接牢固；然后再将电压从近零增加到测试电压。如果测试电压不从近零逐渐提高而是直接施加在电容器上，则施加时应包含*过零点。测试结束时，测试电压应降到近零；然后再将电容器引线或端子从耐电压测试设备的输出端取下。如果测试电压不从近零逐渐提高而是直接施加在电容器上，则可能会出现浪涌电压，从而导致故障。

*过零点是指电压正弦通过0V的位置。

- 参见右图 -

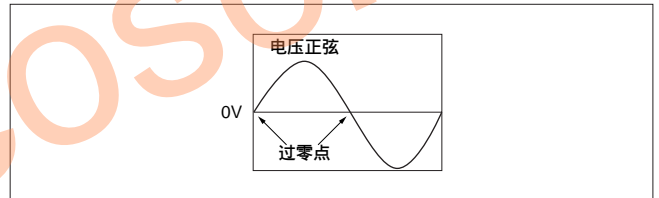

使用本产品时如忽略上述警告事项，则在严重情况下可能导致短路，并引起冒烟或局部离散。



警告 (焊接与安装)

1. 振动与冲击

使用时请勿使电容器受到过度冲击或振动。

2. 电路板材料

电容器有可能由于金属板的膨胀和收缩发生断裂。

如果您想要在金属板 (例如铝) 上使用陶瓷电容器，请与我们联系。

3. PCB分离处的焊盘布局

请选择PCB弯曲或挠曲时元件承受压力最小的位置进行安装。

[元件方向]

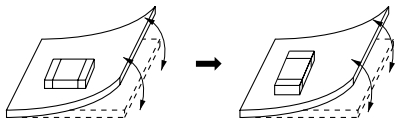

将元件相对于压力作用方向水平放置。

[元件安装位置靠近PCB分离处]

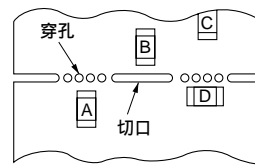

元件排布
最差 A>C>B~D 最佳

接下一页。

警告

☐ 接上页。

4. 回流焊接

如果元件突然受热，则会降低其机械强度。原因是较大的温度变化会导致内件变形。为防止造成机械损坏，应对元件和PCB板进行预热。有关预热条件的说明，请参见表1。应尽可能地保持焊接温度与元件表面温度之间的温差(ΔT)。当采用低温焊接且其峰值焊接温度低于焊锡熔点时，元件镀锡端子的可焊性将下降。使用之前请确认元件镀锡端子的可焊性。

当元件贴装后浸泡在溶剂时，务必将元件与溶剂之间的温差(ΔT) 维持在表1所示的范围内。

表1

品名	温差
G□□18/21/31	ΔT≤190°C
G□□32/42/43/52/55	ΔT≤130°C

建议采用条件

	Pb-Sn焊料		无铅焊料
	红外回流	蒸汽回流	
峰值温度	230-250°C	230-240°C	240-260°C
环境	空气	空气	空气或氮气

Pb-Sn焊料: Sn-37Pb

无铅焊料: Sn-3.0Ag-0.5Cu

[回流焊接的标准条件]

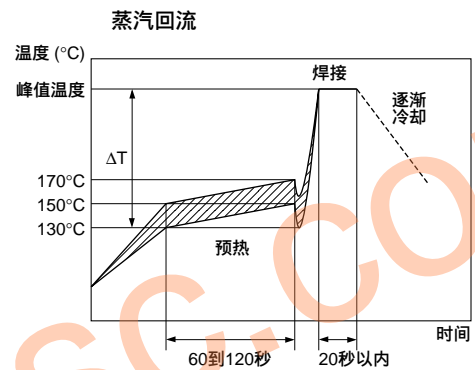
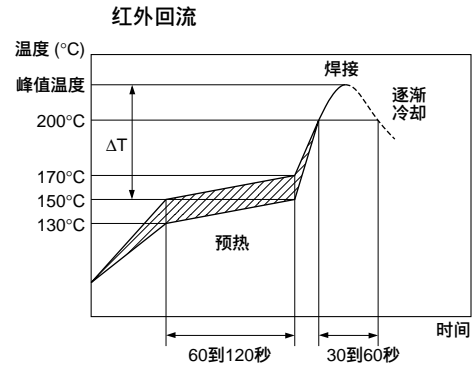

[允许焊接温度及时间]

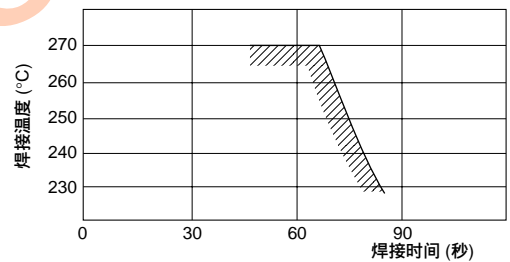

若是重复焊接，则累计焊接时间必须在以上所示的范围内。

回流焊接的最佳焊料用量

使用的锡膏过厚会导致焊接圆角偏高。这会使PCB上的元件更易受机械及热应力影响，而且可能导致元件破损。锡膏太少会造成外部电极上结合强度不够，从而导致元件从PCB上脱落。务必使锡膏均匀分布在终端表面上，厚度至少为0.2mm。

[回流焊接的最佳焊料用量]

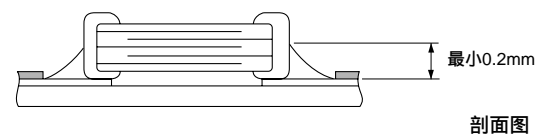

倒置PCB

勿使PCB承受异常机械冲击。

接下页。☐



☐ 接上页。

5. 波峰焊接

如果元件突然受热，则会降低其机械强度。原因是较大的温度变化会导致内件变形。焊接时间过长或温度过高会造成外部电极沥滤，从而会因电极与终端端子之间接触不良而导致结合不牢，或静电容量值降低。

为防止造成机械损坏，应对元件和PCB板进行预热。有关预热条件的说明，请参见表2。应尽可能地保持焊接温度与元件表面温度之间的温差 (ΔT)。

当元件贴装后浸泡在溶剂时，务必将元件与溶剂之间的温差维持在表2所示的范围内。

请勿对表2未列出的元件进行波峰焊接。

表2

品名	温差
G□□18/21/31	$\Delta T \leq 150^\circ\text{C}$

建议采用条件

	Pb-Sn焊料	无铅焊料
峰值温度	240-250°C	250-260°C
环境	空气	氮气

Pb-Sn焊料: Sn-37Pb

无铅焊料: Sn-3.0Ag-0.5Cu

波峰焊接的最佳焊料用量

焊接圆角顶部应低于元件的厚度。如果焊料量过大，则在弯曲或其他应力条件下存在很大的断裂危险。

[波峰焊接的标准条件]

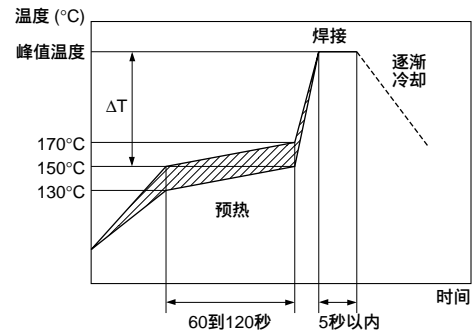

[允许焊接温度及时间]

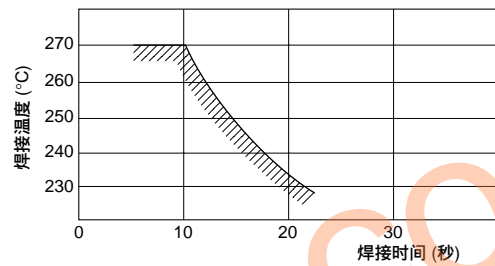

若是重复焊接，则累计焊接时间必须在以上所示的范围内。

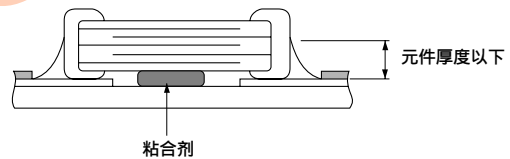

剖面图

☐ 接下页。

警告

☐ 接上页。

6. 使用烙铁进行校正

当使用烙铁焊接时元件突然受热，极端温度变化会导致内部变形，从而降低其机械强度。

为防止造成机械损坏，应对元件和PCB板进行预热。

预热条件 ("烙铁尖端温度", "预热温度", "烙铁尖端与元件和PCB之间的温差") 应该处于表3的条件范围内。

应将烙铁与元件表面之间的温差 (ΔT) 保持尽可能小。

焊接后，切勿使元件/PCB快速冷却。

返修的工作时间应尽可能短。返修时间太长时，可能会导致焊料沥滤，从而会导致终端粘合强度降低。

表3

品名	烙铁头温度	预热温度	温差 (ΔT)	环境
G□□18/21/31	350°C以下	150°C以上	$\Delta T \leq 190^\circ\text{C}$	空气
G□□32/42/43/52/55	280°C以下	150°C以上	$\Delta T \leq 130^\circ\text{C}$	空气

*Pb-Sn焊料和无铅焊料均可使用。
 Pb-Sn焊料: Sn-37Pb
 无铅焊料: Sn-3.0Ag-0.5Cu

使用烙铁返修时的最佳焊料量

如果尺寸小于G 18，那么焊锡圆角顶部应低于元件厚度的2/3或0.5mm (较小者为准)。

如果尺寸大于G 21，那么焊锡圆角顶部应低于元件厚度的2/3。

如果焊料量过大，电容器在弯曲或其他应力条件下存在很大的断裂危险。

要求使用 $\phi 3\text{mm}$ 或更小尺寸的烙铁。

返修过程中需要防止烙铁直接接触元件。

应使用 $\phi 0.5\text{mm}$ 或更细的焊条进行焊接。

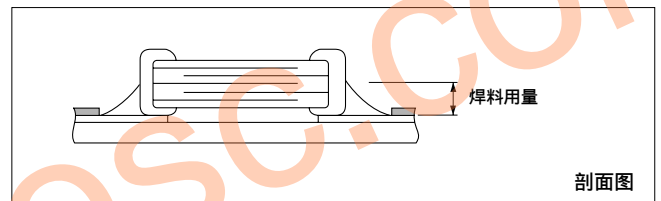

7. 清洗

清洗时若超音波振荡输出过高会导致PCB产生共振，从而造成元件破损或焊缝开裂。请注意不要振动PCB。

使用本产品时如忽略上述警告事项，则在严重情况下可能导致短路及冒烟。

注意事项

注意事项 (焊接与安装)

1. PCB布局构造

安装元件后，如果PCB上所用焊料偏多，机械应力会导致耐破坏特性降低。为防止出现这样的情况，应在设计电路板图前决定其形状及尺寸时特别谨慎。

布局的结构与尺寸 (示例)

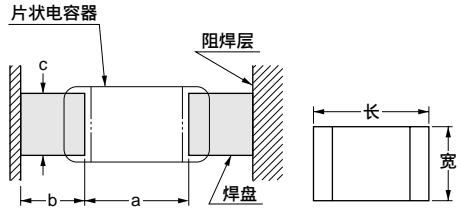

波峰焊接

长 × 宽	a	b	c
1.6×0.8	0.6-1.0	0.8-0.9	0.6-0.8
2.0×1.25	1.0-1.2	0.9-1.0	0.8-1.1
3.2×1.6	2.2-2.6	1.0-1.1	1.0-1.4

波峰焊接: 适用3.2×1.6或以下

回流焊接

长 × 宽	a	b	c
1.6×0.8	0.6-0.8	0.6-0.7	0.6-0.8
2.0×1.25	1.0-1.2	0.9-1.0	0.8-1.1
3.2×1.6	2.2-2.4	0.8-0.9	1.0-1.4
3.2×2.5	2.0-2.4	1.0-1.2	1.8-2.3
4.5×2.0	2.8-3.4	1.2-1.4	1.4-1.8
4.5×3.2	2.8-3.4	1.2-1.4	2.3-3.0
5.7×2.8	4.0-4.6	1.4-1.6	2.1-2.6
5.7×5.0	4.0-4.6	1.4-1.6	3.5-4.8

(in mm)

切口尺寸 (示例)

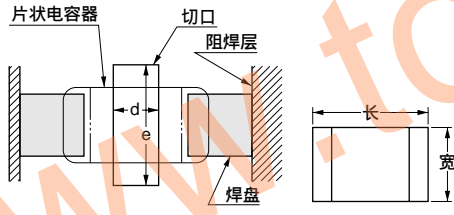

长 × 宽	d	e
1.6×0.8	-	-
2.0×1.25	-	-
3.2×1.6	1.0-2.0	3.2-3.7
3.2×2.5	1.0-2.0	4.1-4.6
4.5×2.0	1.0-2.8	3.6-4.1
4.5×3.2	1.0-2.8	4.8-5.3
5.7×2.8	1.0-4.0	4.4-4.9
5.7×5.0	1.0-4.0	6.6-7.1

(in mm)

预留切口便于清除助焊剂及在电容器背面涂上树脂。但是，切口长度设计应尽可能短，以防电容器因机械外力损坏。较长切口设计可能会使电容器从PCB受到更多的机械应力。下表为建议的切口设计。

防止焊料过量的焊盘布局

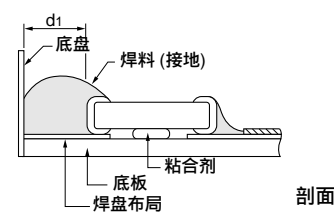
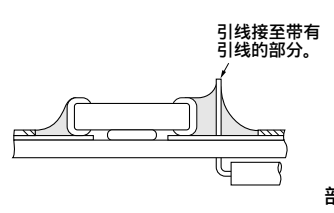
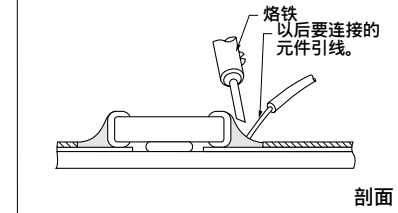
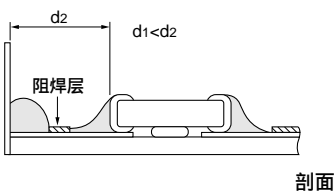
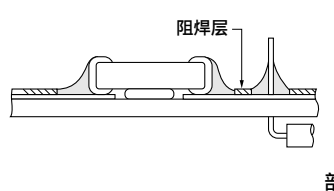
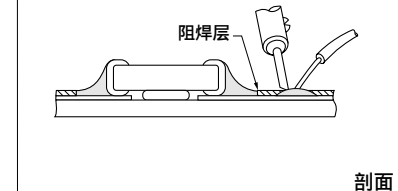
	靠近底盘贴装	安装引脚元件	后安装引脚元件
禁止示例			
通过划分焊盘进行改进的示例			

注意事项

☐ 接上页。

2. 元件的安装

粘合剂的厚度

根据端子或电容器 (20至70 μm) 和焊盘布局的厚度 (30至35 μm)，保持粘合剂的厚度 (50至105 μm 或以上)，以强化粘接触性能。

元件贴装机的机械冲击

如果定位爪与吸嘴磨损，当定位集中在一个位置时负荷会施加到元件上，从而会导致破损、断裂、定位不准等。为防止出现意外故障，应仔细检查维修。

吸嘴在安装时下死点太低会对元件形成较大负荷，从而使元件破损。一般情况下，吸嘴的下死点必须处于 PCB 的上部表面。

3. 焊接

(1) 端子有效面积损失极限和焊接所需条件

由于焊接温度和 (或) 浸泡 (熔化时间) 的情况所致，端子某些部分的有效面积可能会损失。为防止出现这样的情形，焊接时应小心，以使任何可能发生的端子有效面积损失始终不超过下图所示的 A、B、C、D 面总长度 A-B-C-D-A 的 25%。

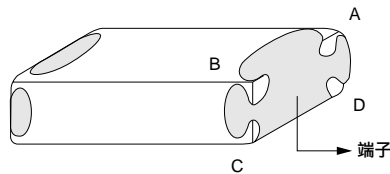

(2) 助焊剂的使用

助焊剂用量过大会产生大量的气体，从而导致可焊性降低。因此应在整个过程中均匀使用少量的助焊剂 (波峰焊接一般采用发泡系统)。

助焊剂中卤化物含量太高可能会导致外部电极腐蚀，除非经过充分的清洗。使用最大卤化物含量为 0.2% 的助焊剂。

请勿使用强酸性助焊剂。

请勿使用水溶性助焊剂*。

(*水溶性助焊剂可定义为非树脂型助焊剂，包括水洗型和非水洗型助焊剂)

4. 清洗

请先确认产品的可靠性没有问题，然后使用指定设备对它进行清洗。

清洗之后的残留物可能导致元件面电阻下降和电极部分的腐蚀等。最终可能导致可靠性下降。在超声波清洁之前，请预先使用指定设备确认没有问题。

5. 树脂涂层

在树脂涂层和封膜之前，请先使用指定设备确认对产品没有影响，然后再进行使用。

树脂用量和涂层厚度的偏差可能会在冷却与加热过程中使元件破裂。

用于涂层和封膜的树脂必须在变硬时应力较小，且吸湿性尽可能较低。

■ 额定值

1. 电容器的静电容量变化

(1) X7R特性时

电容器具有老化特性；因此，电容器若长时间使用，其静电容量会逐渐降低。而且，静电容量还可能会因周围温度或外加电压而发生巨大变化。所以不适合用于时间常数电路。若需详情，请与我公司联系。

(2) X7R特性之外时

静电容量可能会因周围温度或外加电压而发生轻微变化。若要将本产品用于严格的时间常数电路，请与我公司联系。

2. 使用设备进行性能检查

使用电容器之前，请先检查设备的性能和特性没有问题。

一般而言，2级(X7R特性)陶瓷电容器的静电容量具有电压相关特性和温度相关特性。所以，其电容值可能会随设备的工作条件而发生变化。因此，一定要确认仪器接收性能对电容器的静电容量值变化的影响，如漏电流和静噪特性。此外，必要时还要检查电容器在设备中的防电涌性能，因为通过电路的感应，浪涌电压可能会超过规定值。

www.tocosc.com

ISO 9001认证

认证标准

本文中所列的产品由ISO 9001认证的工厂生产。

工厂
株式会社福井村田制作所
株式会社出云村田制作所
株式会社冈山村田制作所
村田电子新加坡有限公司
北京村田电子有限公司
无锡村田电子有限公司

www.tocosc.com

△注:

1. 出口管制

<对于日本国外客户>

不应该通过任何渠道将村田产品用于或者销售给下列用途的设计、开发、生产、利用、维护保养或者运行，或者用作下列用途：（1）武器（大规模杀伤性武器（核武器、化学武器或生物武器或导弹）或常规武器），或者（2）专门为军事最终用途或军事最终用户的应用而设计的产品或系统。

<对于日本国内客户>

根据日本“海外流通以及对外贸易管制法”（Foreign Exchange and Foreign Trade Law）受到管制的产品在出口时必须办理出口许可证。

2. 若将本目录中的产品用于需要极高可靠性以防直接危及第三方生命、身体或财产的下列用途时，或当其中产品用于本目录规定以外的用途时，请提前与我公司销售代表或产品工程师联系。

- ① 飞行设备 ② 宇航设备 ③ 海底设备 ④ 电厂设备 ⑤ 医疗设备 ⑥ 运输设备（汽车、火车、船舶等）
⑦ 交通信号设备 ⑧ 防灾 / 预防犯罪设备 ⑨ 数据处理设备 ⑩ 与上述用途具有类似复杂性和（或）可靠性要求的其它用途

3. 本目录中的产品规格以截止2009年7月的为准。规格若有变更，或若其中产品停产，恕不另行通知。请在订购之前向我公司销售代表或产品工程师查询。若有任何疑问，请与我公司销售代表或产品工程师联系。

4. 请阅读本产品目录中的产品规格，以及有关保管、使用环境、规格上的注意事项、装配时的注意事项、使用时的注意事项的△注意事项，以免发生冒烟和（或）燃烧等。

5. 本目录因没有足够的空间说明详细规格，仅载明标准规格。因此，在订购产品之前，请核准其规格或者办理产品规格表。

6. 请注意，对由于使用我公司产品和（或）本产品目录中所述或记载的产品信息而发生有关我公司和（或）第三方知识产权及其它权利的冲突或争端，我公司概不负责，除非另有规定。由此而论，未经我公司许可，禁止自作主张将上述授权权利转授任何第三方。

7. 我公司在生产过程中未使用蒙特利尔议定书（Montreal Protocol）规定的消耗臭氧层物质（ODS）。



株式会社 村田制作所

<http://www.murata.com/cn/>

<总公司> 株式会社 村田制作所
京都府长冈京市东神足1丁目10番1号 邮政编码617-8555
电话: 81-75-951-9111

<海外营业部> 东京都涩谷区涩谷3丁目29番地12号 邮政编码 150-0002
电话: 81-3-5469-6123 传真: 81-3-5469-6155
E-mail: intl@murata.co.jp

<台湾> 台湾村田股份有限公司 台北营业部
台湾台北市中山北路2段44号中山大楼14楼A室
电话: 886-2-2562-4218 传真: 886-2-2536-6721
E-mail: mtb1@murata.co.jp

<香港> 村田有限公司
香港九龙尖沙咀弥敦道132美丽华大厦810-814室
电话: 852-2376-3898 传真: 852-2375-5655
E-mail: enquiry@murata.com.hk

<中国>

北京村田电子有限公司
北京市顺义县天竺镇天竺空港工农业区天柱路11号
邮政编码: 101312
电话: 86-10-8048-6622 传真: 86-10-8048-6665
E-mail: BS222@murata.co.jp

村田电子贸易(天津)有限公司
天津市和平区南京路189号津汇广场2号楼1502室
邮政编码: 300051
电话: 86-22-8319-1655 传真: 86-22-8319-1656
E-mail: mctsales@murata.co.jp

村田电子贸易(深圳)有限公司
深圳市福田区福中三路1006号诺德金融中心29层
邮政编码: 518026
电话: 86-755-8202-2080 传真: 86-755-8202-2380
E-mail: enquiry@sz.murata.com.cn

村田电子贸易(上海)有限公司
上海市闸北区永和路318弄(东方环球企业中心)2号
邮政编码: 200072
电话: 86-21-3205-4626 传真: 86-21-3205-4611