

# 多層片式陶瓷電容器

## MULTILAYER CHIP CERAMIC CAPACITOR

### ■ 通用型COG/COH片容

通用型COG片容屬於 I 類高頻電容器，其電容量非常穩定，幾乎不隨溫度、電壓和時間的變化而變化。尤其適用於高頻電子線路。

#### ● 特性

- \* 具有高的電容量穩定性,在-55℃ ~ 125℃ 工作範圍內,其溫度系數為 $0 \pm 30\text{ppm}/^\circ\text{C}$ 、 $0 \pm 60\text{ppm}/^\circ\text{C}$ 。
- \* 疊層獨石結構,具有高可靠性。
- \* 優良的焊接性和耐焊性,適用於回流焊和波峰焊。

#### ● 應用

- \* 適用於各種高頻電子線路。

#### ● 產品規格型號表示方法

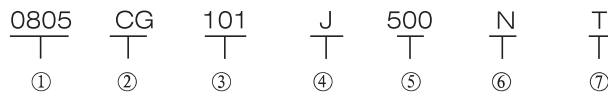

① 尺寸		
型號	英制(英寸)	公制(毫米)
0402	0.04 × 0.02	1.00 × 0.50
0603	0.06 × 0.03	1.60 × 0.80
0805	0.08 × 0.05	2.00 × 1.25
1206	0.12 × 0.06	3.20 × 1.60

② 介質種類	
代碼	介質材料
CG	COG或NPO
CH	COH

③ 標稱電容量(PF)	
表示方式	實際值
100	$10 \times 10^0$
101	$10 \times 10^1$
102	$10 \times 10^2$

④ 誤差級別	
代碼	誤差
J	$\pm 5.00\%$
G	$\pm 2.00\%$
C	$\pm 0.25\text{PF}$
B	$\pm 0.10\text{PF}$
D	$\pm 0.50\text{PF}$

⑤ 工作電壓	
表示方法	實際電壓
6R3	6.3V
100	10V
250	25V
500	50V

⑥ 端頭類別	
表示方法	端頭材料
S	純銀端頭
C	純銅端頭
N	三層電鍍端頭 (銀或銅層/鎳層/錫層)

⑦ 包裝方式	
表示方法	包裝
無標記	袋裝散包裝
T	綳帶包裝
B	塑料盒散包裝

#### ● 外形尺寸

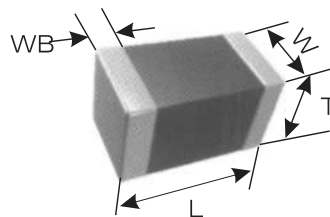

規格型號		尺寸( mm )			
英制表示	公制表示	L	W	T	WB
0402	1005	$1.00 \pm 0.05$	$0.50 \pm 0.05$	$0.50 \pm 0.05$	$0.25 \pm 0.10$
0603	1608	$1.60 \pm 0.10$	$0.80 \pm 0.10$	$0.80 \pm 0.10$	$0.30 \pm 0.10$
0805	2012	$2.00 \pm 0.20$	$1.25 \pm 0.20$	$0.80 \pm 0.10$ $1.00 \pm 0.10$ $1.25 \pm 0.20$	$0.50 \pm 0.25$
1206	3216	$3.20 \pm 0.30$	$1.60 \pm 0.20$	$0.80 \pm 0.10$ $1.00 \pm 0.10$ $1.25 \pm 0.20$	$0.50 \pm 0.25$

## COG/COH MLCC for general-use

COG MLCC for General-use is class I high frequency capacitor, its capacitance is very stable, almost will not change along with the temperature, voltage and time. Specially be suitable for high frequency circuits.

### Features

- \* The capacitance is very stable, its operating temperature is  $-55^{\circ}\text{C}\sim 125^{\circ}\text{C}$ , within the range, the temperature coefficient is  $0\pm 30\text{ppm}/^{\circ}\text{C}$ ,  $0\pm 60\text{ppm}/^{\circ}\text{C}$ .
- \* It has multi-layer monolithic structure, has high reliability.
- \* It has good solderability and soldering resistance, suitable for flow/reflow soldering.

### Application

- \* It is suitable for all kinds of high frequency circuits.

### Product Part Number Expression

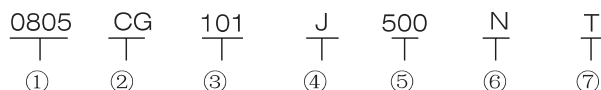

①Dimensions		
Type	British (Inch)	Metric (mm)
0402	$0.04\times 0.02$	$1.00\times 0.50$
0603	$0.06\times 0.03$	$1.60\times 0.80$
0805	$0.08\times 0.05$	$2.00\times 1.25$
1206	$0.12\times 0.06$	$3.20\times 1.60$

②Dielectric Type	
Code	Dielectric
CG	COG or NPO
CH	COH

③Normal Capacitance(PF)	
Expression Method	Actual Value
100	$10\times 10^0$
101	$10\times 10^1$
102	$10\times 10^2$

④Capacitance Tolerance	
Code	Tolerance
J	$\pm 5.00\%$
G	$\pm 2.00\%$
C	$\pm 0.25\text{PF}$
B	$\pm 0.10\text{PF}$
D	$\pm 0.50\text{PF}$

⑤Rated Voltage	
Expression Method	Actual Value
500	50V
250	25V
101	100V
201	200V

⑥Termination Type	
Expression Method	Termination Material
S	Pure Silver
C	Pure Copper
N	Three Layers Plating Terminal (Silver or Copper layer/ Nickel layer /Tin layer)

⑦Package Method	
Expression Method	Packaging
No Mark	Bulk Packaging in a Bag
T	Taping Packaging
B	Bulk Plastic Box Packaging

### Outside Dimension

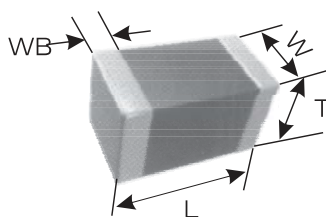

Type		Dimension (mm)			
British Expression	Metric Expression	L	W	T	WB
0402	1005	$1.00\pm 0.05$	$0.50\pm 0.05$	$0.50\pm 0.05$	$0.25\pm 0.10$
0603	1608	$1.60\pm 0.10$	$0.80\pm 0.10$	$0.80\pm 0.10$	$0.30\pm 0.10$
0805	2012	$2.00\pm 0.20$	$1.25\pm 0.20$	$0.80\pm 0.10$ $1.00\pm 0.10$ $1.25\pm 0.20$	$0.50\pm 0.25$
1206	3216	$3.20\pm 0.30$	$1.60\pm 0.20$	$0.80\pm 0.10$ $1.00\pm 0.10$ $1.25\pm 0.20$	$0.50\pm 0.25$

# 多層片式陶瓷電容器

## MULTILAYER CHIP CERAMIC CAPACITOR

- 電容量範圍

項目	通用型COG/COH片容																			
	0402					0603					0805					1206				
尺寸																				
工作電壓	6.3V	10V	16V	25V	50V	6.3V	10V	16V	25V	50V	6.3V	10V	16V	25V	50V	6.3V	10V	16V	25V	50V
電容量																				
0.5PF																				
1PF																				
2PF																				
3PF																				
4PF																				
5PF																				
6PF																				
7PF																				
10PF																				
22PF																				
33PF																				
47PF																				
68PF																				
100PF																				
120PF																				
150PF																				
180PF																				
220PF																				
330PF																				
470PF																				
560PF																				
680PF																				
1000PF																				
2200PF																				
2700PF																				
3300PF																				
4700PF																				
5600PF																				
6800PF																				
10nF																				
12nF																				
15nF																				
22nF																				
27nF																				
33nF																				
47nF																				

**Capacitance Range**

Item	COG/COH MLCC for general-use																			
	0402					0603					0805					1206				
Rated Voltage	6.3V	10V	16V	25V	50V	6.3V	10V	16V	25V	50V	6.3V	10V	16V	25V	50V	6.3V	10V	16V	25V	50V
Capacitance																				
0.5PF																				
1PF																				
2PF																				
3PF																				
4PF																				
5PF																				
6PF																				
7PF																				
10PF																				
22PF																				
33PF																				
47PF																				
68PF																				
100PF																				
120PF																				
150PF																				
180PF																				
220PF																				
330PF																				
470PF																				
560PF																				
680PF																				
1000PF																				
2200PF																				
2700PF																				
3300PF																				
4700PF																				
5600PF																				
6800PF																				
10nF																				
12nF																				
15nF																				
22nF																				
27nF																				
33nF																				
47nF																				

# 多層片式陶瓷電容器

## MULTILAYER CHIP CERAMIC CAPACITOR

### ■ 通用型COG、COH、PH~SL可靠性測試方法

編號	項目	標準		測試方法									
		通用型COG、COH片容	通用型PH、RH、SH、TH、UJ、SL片容										
1	工作溫度範圍	-55℃ ~ 125℃	-55℃ ~ 85℃										
2	外觀	1. 瓷體顏色一致性好。 2. 芯片無可見損傷,光滑平整。 3. 瓷體無外露電極,裂痕,孔洞。 4. 端電極無裂痕,孔洞,磨損及表面氧化等。 5. 端電極應無延伸現象或延伸部分不超過端頭寬度的一半。		※在 $\geq 10\times$ 倍以上的顯微鏡下觀察。									
3	尺寸	在規定尺寸範圍內		※使用千分尺或游標卡尺。									
4	電容量	在規定偏差範圍內		※測試儀器:HP4278A電橋、HP4284電橋。									
5	損耗因數(D.F.)	$Cr < 5PF \quad < 0.56\%$ $5PF \leq Cr < 50PF \quad 1.5 [(150/Cr)+7] \times 10^{-4}$ $Cr \geq 50PF \quad < 0.15\%$		※測試條件: 1. 測試溫度: $25^\circ C \pm 5^\circ C$ , 濕度: 30% ~ 75%。 2. 測試電壓: $1.0 \pm 0.2V$ 。 3. 測試頻率: $C < 1000PF, 1.0 \pm 0.1MHz$ ; $C \geq 1000PF, 1.0 \pm 0.1KHz$									
6	絕緣電阻 (I.R.)	$C \leq 10nF \quad Ri \geq 5 \times 10^{10} \Omega$ $C > 10nF \quad Ri \cdot Cr \geq 500s$		※測試儀器: 絕緣電阻測試儀(如: SF2511絕緣測試機)。 ※測試方法: 施加額定工作電壓, 在 $60 \pm 5$ 秒內測量絕緣電阻。									
7	耐電壓強度	$> 3 \times$ 額定工作電壓		※施加3倍額定工作電壓, 持續 $60 \pm 1$ 秒, 未出現擊穿現象并且充電 / 放電電流低於50mA。									
8	電容量溫度特性	在工作溫度範圍內符合電容器特性溫度系數要求		※首先進行預處理: 進行 $150+0/-10^\circ C$ 熱處理 $60 \pm 5$ 分鐘, 然后在室溫條件下放置 $24 \pm 2$ 小時。 ※在 $-55 \sim 125^\circ C$ 或者 $-55 \sim 85^\circ C$ 範圍內測試電容量, 其電容值相對於 $25^\circ C$ 時數值的變化率應在規定範圍內。									
9	可焊性	75% 端電極覆蓋錫		※將電容器浸在乙醇和松香溶液中。然後浸入有鉛 $235 \pm 5^\circ C$ (無鉛 $245 \pm 5^\circ C$ ) 的混合焊錫溶液 $2 \pm 0.5$ 秒。浸入速度: $25 \pm 2.5mm/秒$ 。									
10	耐焊接熱	外觀 電容量變化率 D.F. I.R.	無明顯缺陷 $\leq \pm 5\%$ 或 $\pm 0.5PF$ 取兩者中最大的 同初始標準 同初始標準	※首先進行預處理: 進行 $150+0/-10^\circ C$ 熱處理 $60 \pm 5$ 分鐘, 然后在室溫條件下放置 $24 \pm 2$ 小時。 ※然後按下表預熱電容器。將電容器浸入 $260 \pm 5^\circ C$ 的混合焊錫溶液 $10 \pm 1$ 秒。再在室溫條件下放置 $24 \pm 2$ 小時, 然後進行測量。 浸入速度: $25 \pm 2.5mm/秒$ 。 ※預熱條件如下:									
				<table border="1"> <thead> <tr> <th>階段</th> <th>溫度</th> <th>時間</th> </tr> </thead> <tbody> <tr> <td>1</td> <td><math>100^\circ C - 120^\circ C</math></td> <td>1分鐘</td> </tr> <tr> <td>2</td> <td><math>170^\circ C - 200^\circ C</math></td> <td>1分鐘</td> </tr> </tbody> </table>	階段	溫度	時間	1	$100^\circ C - 120^\circ C$	1分鐘	2	$170^\circ C - 200^\circ C$	1分鐘
階段	溫度	時間											
1	$100^\circ C - 120^\circ C$	1分鐘											
2	$170^\circ C - 200^\circ C$	1分鐘											

• General COG、COH、PH~SL MLCC reliability test method

Number	Item	Standard		Test Method									
		COG、COH MLCC for General-use	PH, RH, SH, TH, UJ, SL MLCC for General-use										
1	Operating Temperature Range	-55℃~125℃	-55℃~85℃										
2	Appearance	1.Good ceramic body color continuity. 2.The chips have no visual damages and must be very smooth. 3.No exposed inner- electrode, no cracks or holes. 4.The outer electrode should have no cracks, holes, damages or surface oxidation. 5.Outer electrode no prolongation or the prolongation is less than half of that of the termination width.		※Check by using microscope $\geq 10\times$ .									
3	Dimensions	Within the specified dimensions		※Using micrometer or vernier calipers									
4	Capacitance	Within the specified tolerance		※Measuring Equipments:HP4278 capacitance meter,HP4284 capacitance,									
5	Dissipation Factor (DF)	Cr<5PF $\leq 0.56\%$ 5PF<Cr<50PF $1.5 [(150/Cr)+7] \times 10^{-4}$ Cr>50PF $\leq 0.15\%$		※Measuring Conditions: 1.Measuring Temperature:25℃ $\pm 5^\circ$ C.Humidity: 30%~75%. 2.Measuring Voltage:1.0 $\pm 0.2$ V. 3.Measuring Frequency:C<1000PF, 1.0 $\pm 0.1$ MHz C $\geq 1000$ PF, 1.0 $\pm 0.1$ KHz									
6	Insulation Resistance	C $\leq 10$ nF Ri $\geq 5 \times 10^{10} \Omega$ C>10nF Ri · Cr $> 500$ s		※Measuring Equipment:Insulation resistance meter (such as Sf2511 insulation resistance). ※Measuring Method:Must measure at rated voltage, and measure the IR within 60 $\pm 5$ seconds.									
7	Withstanding Voltage	>3x rated continuous working voltage		※Must measure at 3 times rated voltage, dwell time: 60 $\pm 1$ seconds, no short and the changing/discharging current less than 50mA.									
8	Capacitance Temperature Characteristic	Must meet the capacitor character temperature coefficient requirements within the operating temperature range.		※First, pre-heat: heat treat 60 $\pm 5$ minutes at 150+0/-10℃, then set it for 24 $\pm 2$ hours at room temperature. ※Measure the capacitance at -55~125℃ or -55~85℃, the capacitance change ratio comparing to that of 25℃ must be within the specified range.									
9	Solderability	Tin coverage should be 75% of the outer electrode		※Dip the capacitor into ethanol or colophony solution, and then dip it into 235 $\pm 5^\circ$ C ( or 245 $\pm 5^\circ$ C leadless eutectic solder solution ) eutectic solder solution having lead for 2 $\pm 0.5$ seconds. Dipping speed: 25 $\pm 2.5$ mm/second.									
10	Resistance to Soldering	Appearance	No defects visible	※First pre-heat: heat treat for 60 $\pm 5$ minutes at 150+0/-10℃, then set it for 24 $\pm 2$ hours at room temperature. ※Then pre-heat the capacitance according to the following chart. Dip the capacitor into 260 $\pm 5^\circ$ C eutectic solder solution for 10 $\pm 1$ seconds. Then set it for 24 $\pm 2$ hours at room temperature, then measure. Dipping speed: 25 $\pm 2.5$ mm/second. ※Preheat conditions:									
		Cap. Change ratio	$\leq \pm 5\%$ or $\pm 0.5$ PF (whichever is larger)										
		DF	Same as original spec										
		IR	Same as original spec										
				<table border="1"> <thead> <tr> <th>Stage</th> <th>Temperature</th> <th>Time</th> </tr> </thead> <tbody> <tr> <td>1</td> <td>100℃—120℃</td> <td>1minute</td> </tr> <tr> <td>2</td> <td>170℃—200℃</td> <td>1minute</td> </tr> </tbody> </table>	Stage	Temperature	Time	1	100℃—120℃	1minute	2	170℃—200℃	1minute
Stage	Temperature	Time											
1	100℃—120℃	1minute											
2	170℃—200℃	1minute											

# 多層片式陶瓷電容器

## MULTILAYER CHIP CERAMIC CAPACITOR

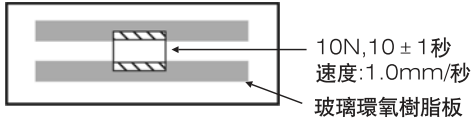
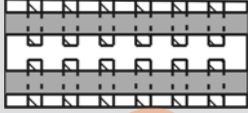
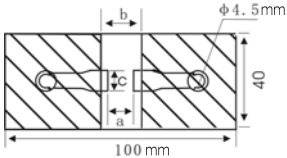
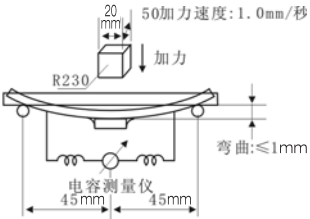
編號	項目	標準		測試方法																						
11	端電極結合強度	不應出現端頭脫落或其它缺陷。		<p>※使用混合焊錫將電容器焊接在圖 1 中所示的測試夾具( 玻璃環氧樹脂板) 上。然後沿箭頭方向施加 10N 的力。焊接應利用烙鐵或使用回流焊方法進行，而且應謹慎作業，以使焊接均勻且不會出現熱衝擊等不良現象。</p>  <p>10N, 10 ± 1 秒 速度: 1.0mm/秒 玻璃環氧樹脂板</p> <p>圖 1</p>																						
12	耐振動性	外觀	無明顯缺陷	<p>※將電容器焊接在測試夾具( 玻璃環氧樹脂板) 上。電容器應進行簡諧運動，其總幅值為 1.5mm，頻率在近似 10—55Hz 之間均勻變化。頻率範圍( 從 10 至 55Hz 再返回 10Hz) 應在約 1 分鐘內完成。振動應在三個相互垂直方向各進行 2 小時( 總計 6 小時) 。</p>  <p>圖 2</p>																						
		電容量	在規定偏差範圍內																							
		D.F.	同初始標準																							
13	抗彎曲性	不應出現裂縫或其他缺陷。		<p>※使用混合焊錫將電容器焊接在圖 3 中所示的測試夾具( 玻璃環氧樹脂板) 上，然後在圖 4 所示的方向加力。焊接應利用烙鐵或使用回流焊方法進行，而且應謹慎作業，以使焊接均勻且不會出現熱衝擊等不良現象。</p>  <p>圖 3</p>  <p>圖 4</p> <table border="1" data-bbox="906 1568 1252 1713"> <thead> <tr> <th rowspan="2">L×W (mm)</th> <th colspan="4">尺寸 (mm)</th> </tr> <tr> <th>a</th> <th>b</th> <th>c</th> <th>d</th> </tr> </thead> <tbody> <tr> <td>4.5×2.0</td> <td>3.5</td> <td>7.0</td> <td>2.4</td> <td rowspan="3">1.0</td> </tr> <tr> <td>4.5×3.2</td> <td>3.5</td> <td>7.0</td> <td>3.7</td> </tr> <tr> <td>5.7×6.3</td> <td>4.5</td> <td>8.0</td> <td>5.6</td> </tr> </tbody> </table>	L×W (mm)	尺寸 (mm)				a	b	c	d	4.5×2.0	3.5	7.0	2.4	1.0	4.5×3.2	3.5	7.0	3.7	5.7×6.3	4.5	8.0	5.6
L×W (mm)	尺寸 (mm)																									
	a	b	c	d																						
4.5×2.0	3.5	7.0	2.4	1.0																						
4.5×3.2	3.5	7.0	3.7																							
5.7×6.3	4.5	8.0	5.6																							
14	溫度循環	外觀	無缺陷或異常	<p>※首先進行預處理：進行 150+0/-10℃ 熱處理 60 ± 5 分鐘，然後在室溫條件下放置 24 ± 2 小時。</p> <p>※按照下表中列出的四種熱處理方法執行五次循環。</p> <p>在室溫條件下放置 24 ± 2 小時，然後進行測量。</p>																						

Number	Items	Standard		Test Method																						
11	Adhesive Strength of Termination	No removal of the terminations or other defect shall occur		<p>※Solder the capacitor to the test jig (glass epoxy resin board) shown in Fig.1 using a eutectic solder. Then apply a 10N force in the direction shown as the arrowhead. The soldering shall be done either with an iron or using the reflow method and shall be conducted with care so that the soldering is uniform and free of defects such as heat shock, etc.</p> <p>10N, 10±1s Speed: 1.0mm/s Glass epoxy resin board</p> <p>Fig.1</p>																						
12	Vibration Resistance	Appearance	No defects or abnormalities	<p>※Solder the capacitor to the test jig (glass epoxy resin board). The capacitor should be subjected to a simple harmonic motion having a total amplitude of 1.5mm, the frequency being varied uniformly between the approximate limits of 10 and 55Hz, shall be traversed (from 10 Hz to 55 Hz then 10 Hz again) in approximately 1 minute. This motion shall be applied for a period of 2 hours in each 3 mutually perpendicular directions (total is 6 hours).</p> <p>Fig.2</p>																						
		Capacitance	Within the specified tolerance range																							
		DF	Same as original spec																							
13	Bending Resistance	No cracks or other defects shall occur		<p>※Solder the capacitor to the test jig (glass epoxy resin board) shown in Fig.3 using a eutectic solder. Then apply a 10N force in the direction shown as Fig.4. The soldering shall be done either with an iron or using the reflow method and shall be conducted with care so that the soldering is uniform and free of defects such as heat shock, etc.</p> <p>Fig.3</p> <p>Fig.4</p> <table border="1"> <thead> <tr> <th rowspan="2">L×W (mm)</th> <th colspan="4">Dimension</th> </tr> <tr> <th>a</th> <th>b</th> <th>c</th> <th>d</th> </tr> </thead> <tbody> <tr> <td>4.5×2.0</td> <td>3.5</td> <td>7.0</td> <td>2.4</td> <td rowspan="3">1.0</td> </tr> <tr> <td>4.5×3.2</td> <td>3.5</td> <td>7.0</td> <td>3.7</td> </tr> <tr> <td>5.7×6.3</td> <td>4.5</td> <td>8.0</td> <td>5.6</td> </tr> </tbody> </table>	L×W (mm)	Dimension				a	b	c	d	4.5×2.0	3.5	7.0	2.4	1.0	4.5×3.2	3.5	7.0	3.7	5.7×6.3	4.5	8.0	5.6
L×W (mm)	Dimension																									
	a	b	c	d																						
4.5×2.0	3.5	7.0	2.4	1.0																						
4.5×3.2	3.5	7.0	3.7																							
5.7×6.3	4.5	8.0	5.6																							
14	Temperature Cycle	Appearance	No defects or abnormalities	<p>※Pre-treatment: Heat-treat the capacitor for 60±5 minutes at 150+0/-10℃, then set it for 24±2 hours at room temperature.</p> <p>※Perform five cycles according to the four heat treatments listed in the following table. Set it for 24±2 hours at room temperature, then measure.</p>																						



# 多層片式陶瓷電容器

## MULTILAYER CHIP CERAMIC CAPACITOR

編號	項目	標準		測試方法															
14	溫度循環	電容量	$\leq \pm 2.5\%$ 或 $\pm 0.25\text{PF}$ ,取兩者中最大的。	熱處理方法如下表: <table border="1" style="margin-left: 20px;"> <thead> <tr> <th>階段</th> <th>溫度(℃)</th> <th>時間(分鐘)</th> </tr> </thead> <tbody> <tr> <td>1</td> <td>最低工作溫度<math>\pm 3</math></td> <td><math>30 \pm 3</math></td> </tr> <tr> <td>2</td> <td>常溫</td> <td>2—3</td> </tr> <tr> <td>3</td> <td>最高工作溫度<math>\pm 2</math></td> <td><math>30 \pm 3</math></td> </tr> <tr> <td>4</td> <td>常溫</td> <td>2—3</td> </tr> </tbody> </table>	階段	溫度(℃)	時間(分鐘)	1	最低工作溫度 $\pm 3$	$30 \pm 3$	2	常溫	2—3	3	最高工作溫度 $\pm 2$	$30 \pm 3$	4	常溫	2—3
		階段	溫度(℃)		時間(分鐘)														
		1	最低工作溫度 $\pm 3$		$30 \pm 3$														
2	常溫	2—3																	
3	最高工作溫度 $\pm 2$	$30 \pm 3$																	
4	常溫	2—3																	
D.F.	同初始標準																		
I.R.	大于10000M $\Omega$																		
15	濕度(穩態)	外觀	無缺陷或異常	※在 $40 \pm 2^\circ\text{C}$ 和 90—95% 相對濕度條件下放置 $500 \pm 24/-0$ 小時。 然後將其移動到室溫條件下恢復放置 $24 \pm 2$ 小時，進行測量。															
		電容量	$\leq \pm 5\%$ 或 $\pm 0.5\text{PF}$ ,取兩者中最大的。																
		D.F.	同初始標準																
I.R.	大于10000M $\Omega$																		
16	濕度負荷	外觀	無缺陷或異常	※在 $40 \pm 2^\circ\text{C}$ 和 90—95% 相對濕度條件下施加額定電壓 $500 \pm 24/-0$ 小時。然後將其移動到室溫條件下放置 $24 \pm 2$ 小時， 進行測量。															
		電容量	$\leq \pm 5\%$ 或 $\pm 0.5\text{PF}$ ,取兩者中最大的。																
		D.F.	同初始標準																
I.R.	大于10000M $\Omega$																		
17	壽命	外觀	無缺陷或異常	※在上限溫度下施加2倍的額定工作電壓 $1000 \pm 12$ 小時，充放電電 流不超過50mA。將其移動到室溫條件下恢復放置 $24 \pm 2$ 小時， 進行測量。															
		電容量	$\leq \pm 5\%$ 或 $\pm 0.5\text{PF}$ ,取兩者中最大的。																
		D.F.	同初始標準																
I.R.	大于10000M $\Omega$																		

Number	Item	Standard		Test Method															
14	Temperature Cycle	Cap. Change ratio	$\leq \pm 2.5\%$ or $\pm 0.25$ PF (whichever is larger)	※Heat-treatment: <table border="1" style="margin-left: 20px;"> <thead> <tr> <th>stage</th> <th>temperature (°C)</th> <th>time (min.)</th> </tr> </thead> <tbody> <tr> <td>1</td> <td>lowest operating temperature <math>\pm 3</math></td> <td><math>30 \pm 3</math></td> </tr> <tr> <td>2</td> <td>normal temperature</td> <td>2—3</td> </tr> <tr> <td>3</td> <td>high operating temperature <math>\pm 2</math></td> <td><math>30 \pm 3</math></td> </tr> <tr> <td>4</td> <td>normal temperature</td> <td>2—3</td> </tr> </tbody> </table>	stage	temperature (°C)	time (min.)	1	lowest operating temperature $\pm 3$	$30 \pm 3$	2	normal temperature	2—3	3	high operating temperature $\pm 2$	$30 \pm 3$	4	normal temperature	2—3
		stage	temperature (°C)		time (min.)														
		1	lowest operating temperature $\pm 3$		$30 \pm 3$														
		2	normal temperature		2—3														
3	high operating temperature $\pm 2$	$30 \pm 3$																	
4	normal temperature	2—3																	
D.F.	Same as original spec																		
I.R.	More than $10000M\Omega$																		
15	Humidity Steady State	Appearance	No defects or abnormalities	※Set the capacitor for $500+24/-0$ hours at the condition of $40 \pm 2^\circ\text{C}$ and 90-95% humidity. Then remove and set it for $24 \pm 2$ hours at room temperature, then measure.															
		Cap. Change ratio	$\leq \pm 5\%$ or $\pm 0.5$ PF (whichever is larger)																
		D.F.	Same as original spec																
		I.R.	More than $10000M\Omega$																
16	Humidity Load	Appearance	No defects or abnormalities	※Apply rated voltage to the capacitor for $500+24/-0$ hours at the condition of $40 \pm 2^\circ\text{C}$ and 90-95% humidity. Remove and set it for $24 \pm 2$ hours at room temperature, then measure.															
		Cap. Change ratio	$\leq \pm 5\%$ or $\pm 0.5$ PF (whichever is larger)																
		D.F.	Same as original spec																
		I.R.	More than $10000M\Omega$																
17	Life Test	Appearance	No defects or abnormalities	※Apply two times rated voltage to the capacitor for $1000 \pm 12$ hours at the upper temperature limits, the charging current should be less than 50mA. Remove and set it for $24 \pm 2$ hours at room temperature, then measure.															
		Cap. Change ratio	$\leq \pm 5\%$ or $\pm 0.5$ PF (whichever is larger)																
		D.F.	Same as original spec																
		I.R.	More than $10000M\Omega$																

■ 通用型片容特性曲綫

- COG和PH、RH、SH、TH、UH系列

溫度系數圖

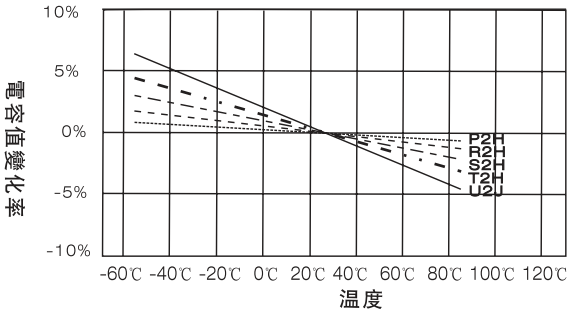

X7R溫度特性

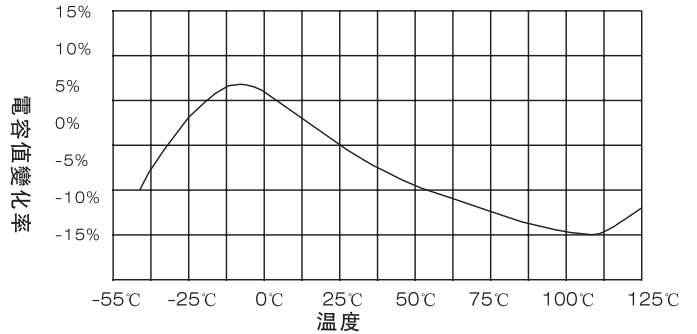

Z5U溫度特性

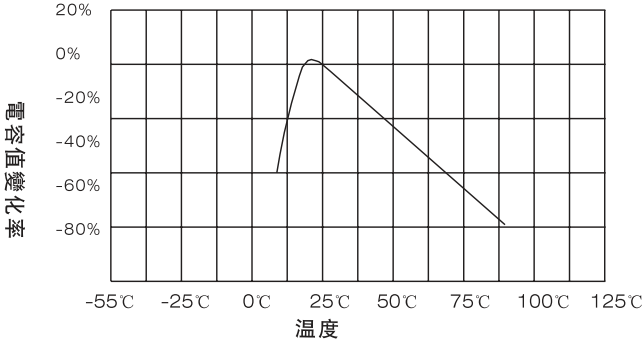

Y5V溫度特性

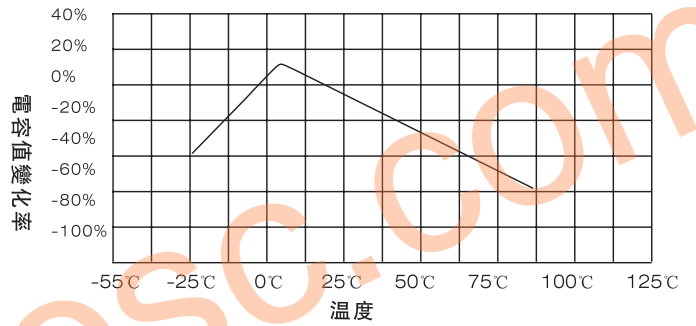

- 電容器偏壓特性圖

測量條件: COG :1MHZ  
X7R,Z5U,Y5V:1KHZ

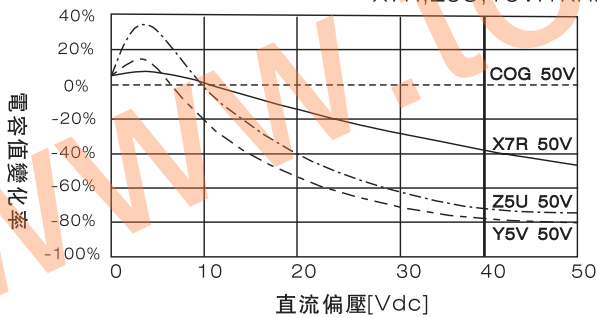

- 電容器交流電壓特性圖

測量條件: COG :1MHZ  
X7R,Z5U,Y5V:1KHZ

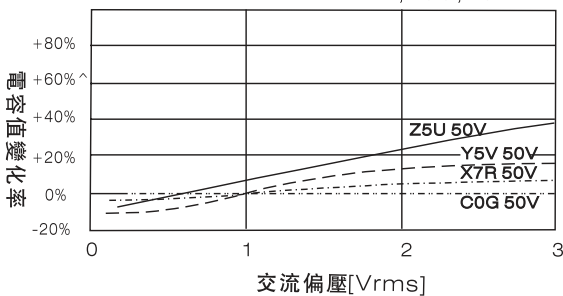

- 電容器老化特性圖

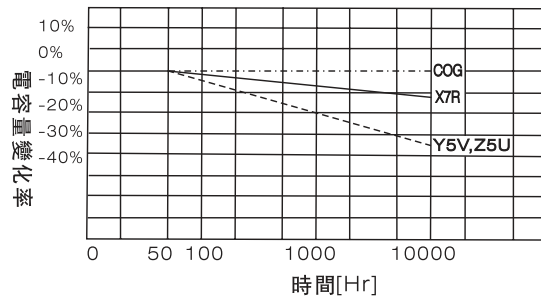

■ GENEREL-USE MLCC CHARCCTER PROFILES

- COG and PH、RH、SH、TH、UH saries temperature coefficient

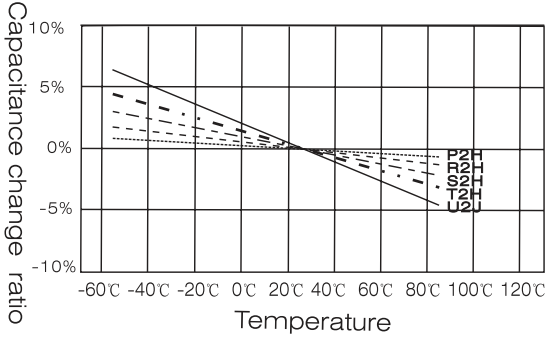

X7R temprture characteristics

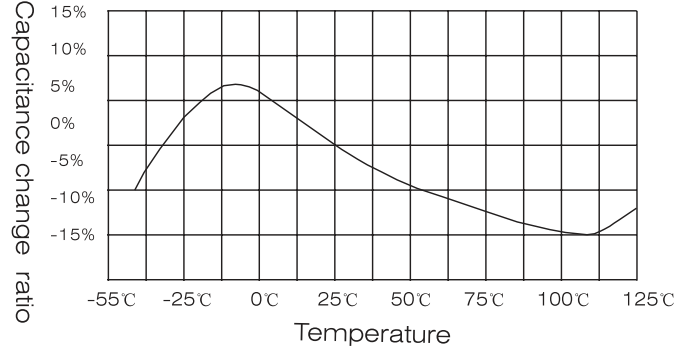

Z5U temperature character

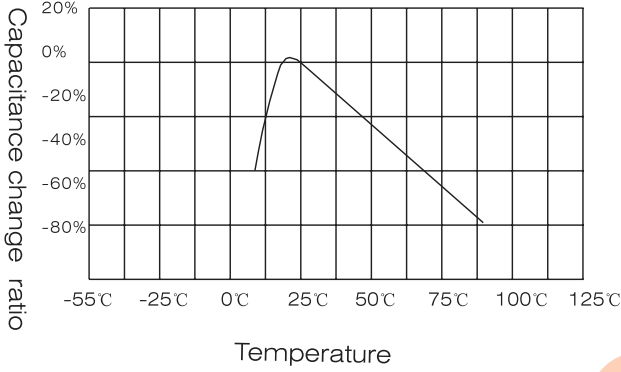

Y5V temperature characteristics

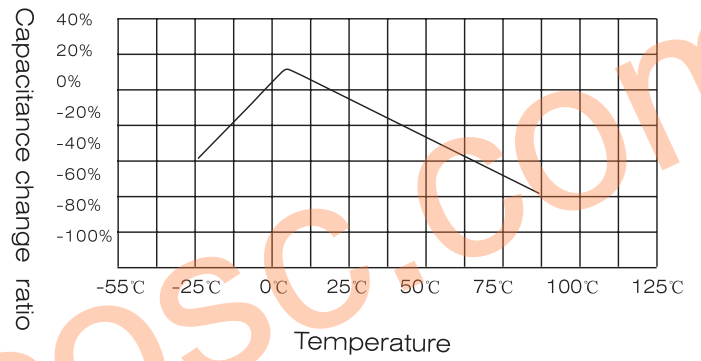

- DC Voltage Characteristics

Measuring condition COG :1MHz  
X7R、Z5U、Y5V:1KHz

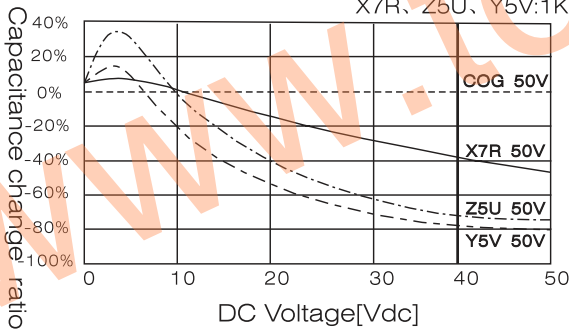

- Capacitance-AC Voltage

Characterics

Measuring condition: COG :1MHz  
X7R,Z5U,Y5V:1KHz

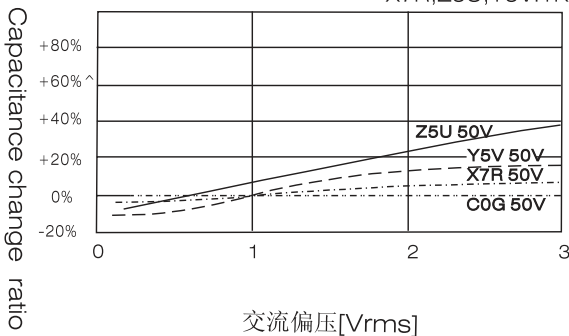

- Capacitance change aging

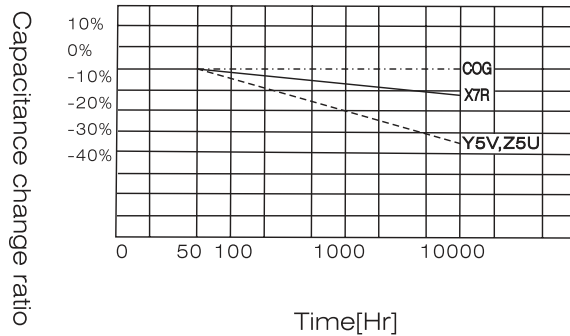

# 多層片式陶瓷電容器

## MULTILAYER CHIP CERAMIC CAPACITOR

### ■ 包裝

- 紙帶卷盤結構

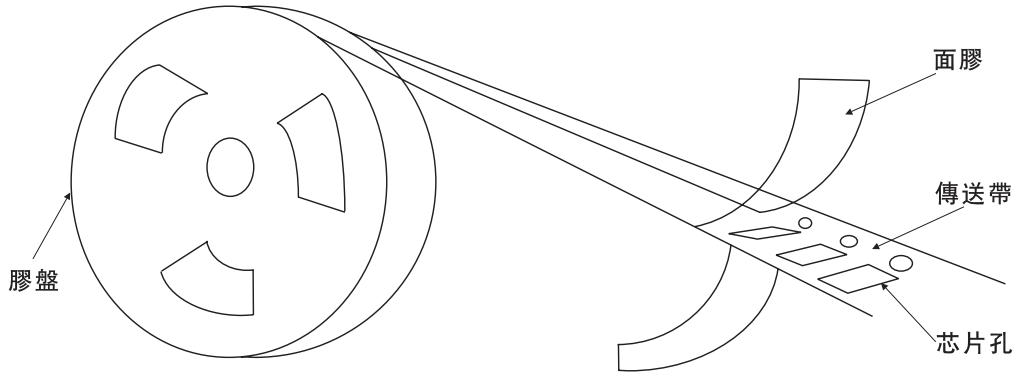

\* 適合 0402, 0603, 0805, 1206 常規尺寸產品的紙帶尺寸

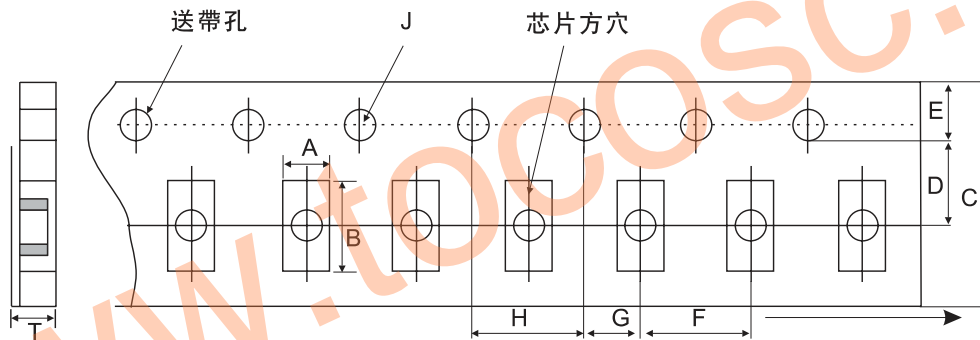

代號 紙帶規格	A	B	C	D	E	F	G	H	J	T*
0402	0.65 ±0.10	1.15 ±0.10	8.00 ±0.10	3.50 ±0.05	1.75 ±0.10	2.00 ±0.05	2.00 ±0.05	4.00 ±0.10	1.50-0/ +0.10	低于 0.80
0603	1.10 ±0.20	1.90 ±0.20	8.00 ±0.20	3.50 ±0.05	1.75 ±0.10	4.00 ±0.10	2.00 ±0.10	4.00 ±0.10	1.50-0/ +0.10	低于 1.10
0805	1.45 ±0.20	2.30 ±0.20	8.00 ±0.20	3.50 ±0.05	1.75 ±0.10	4.00 ±0.10	2.00 ±0.10	4.00 ±0.10	1.50-0/ +0.10	低于 1.10
1206	1.80 ±0.20	3.40 ±0.20	8.00 ±0.20	3.50 ±0.05	1.75 ±0.10	4.00 ±0.10	2.00 ±0.10	4.00 ±0.10	1.50-0/ +0.10	低于 1.10

## ■ Package

- Paper Tape Taping

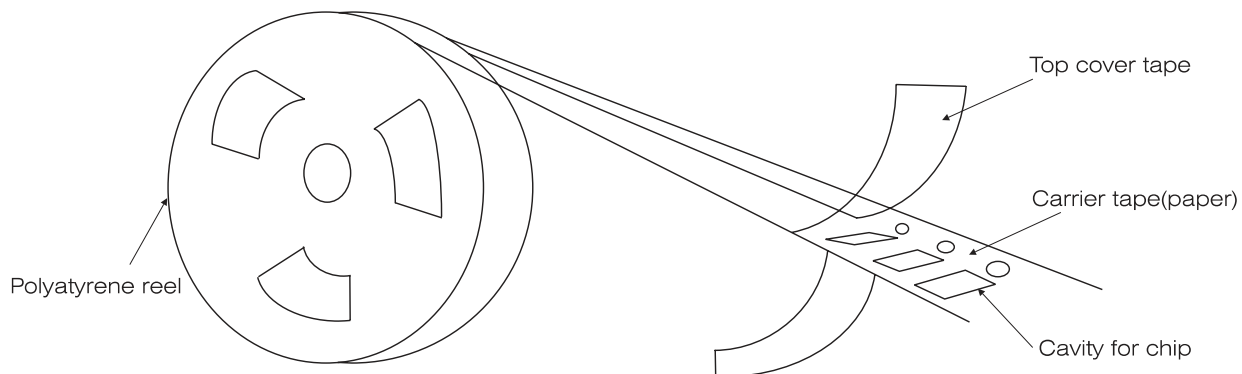

※Dimensions of paper take taping for 0402, 0603, 0805, 1206

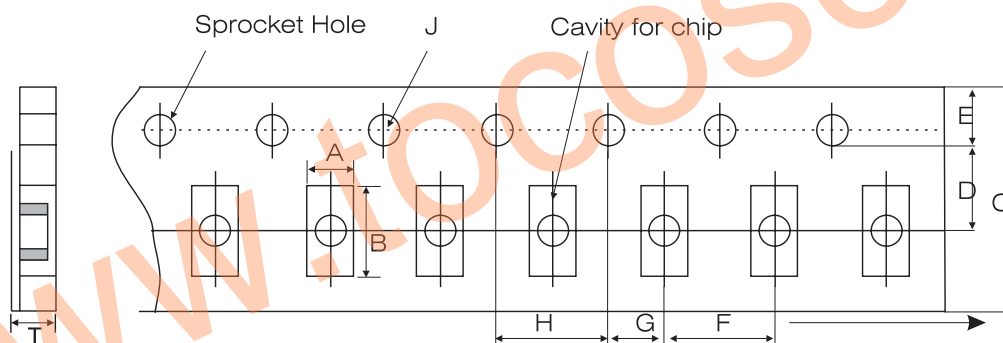

Code Paper size	A	B	C	D	E	F	G	H	J	T*
0402	0.65 ±0.10	1.15 ±0.10	8.00 ±0.10	3.50 ±0.05	1.75 ±0.10	2.00 ±0.05	2.00 ±0.05	4.00 ±0.10	1.50-0/ +0.10	Below 0.80
0603	1.10 ±0.20	1.90 ±0.20	8.00 ±0.20	3.50 ±0.05	1.75 ±0.10	4.00 ±0.10	2.00 ±0.10	4.00 ±0.10	1.50-0/ +0.10	Below 1.10
0805	1.45 ±0.20	2.30 ±0.20	8.00 ±0.20	3.50 ±0.05	1.75 ±0.10	4.00 ±0.10	2.00 ±0.10	4.00 ±0.10	1.50-0/ +0.10	Below 1.10
1206	1.80 ±0.20	3.40 ±0.20	8.00 ±0.20	3.50 ±0.05	1.75 ±0.10	4.00 ±0.10	2.00 ±0.10	4.00 ±0.10	1.50-0/ +0.10	Below 1.10

■ 包裝

- 紙帶卷盤結構

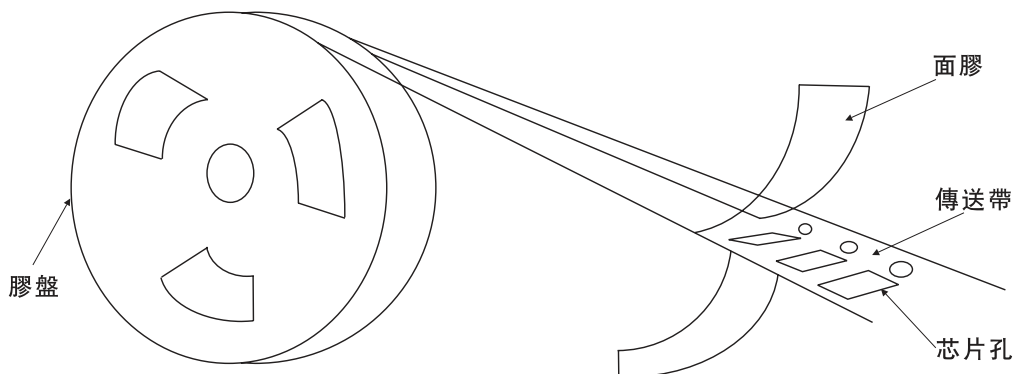

\* 適合0805, 1206, 1210, 1808, 1812常規尺寸產品的塑膠帶尺寸

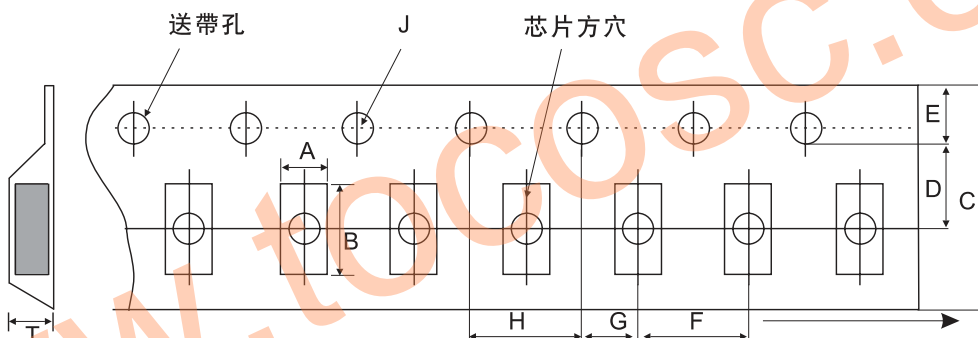

代號 紙帶規格	A	B	C	D	E	F*	G	H	J	T
0805	1.55 ±0.20	2.35 ±0.20	8.00 ±0.20	3.50 ±0.05	1.75 ±0.10	4.00 ±0.10	2.00 ±0.10	4.00 ±0.10	1.50-0/ +0.10	低於 1.50
1206	1.95 ±0.20	3.60 ±0.20	8.00 ±0.20	3.50 ±0.05	1.75 ±0.10	4.00 ±0.10	2.00 ±0.10	4.00 ±0.10	1.50-0/ +0.10	低於 1.85
1210	2.70 ±0.10	3.42 ±0.10	8.00 ±0.10	3.50 ±0.05	1.75 ±0.10	4.00 ±0.10	2.00 ±0.05	4.00 ±0.10	1.50-0/ +0.10	低於 3.2
1808	2.20 ±0.10	4.95 ±0.10	12.00 ±0.10	5.50 ±0.05	1.75 ±0.10	4.00 ±0.10	2.00 ±0.05	4.00 ±0.10	1.50-0/ +0.10	低於 3.0
1812	3.66 ±0.10	4.95 ±0.10	12.00 ±0.10	5.50 ±0.05	1.75 ±0.10	8.00 ±0.10	2.00 ±0.05	4.00 ±0.10	1.50-0/ +0.10	低於 4.0

注意:\*表示此處對尺寸的要求非常精確

• Embossed Taping

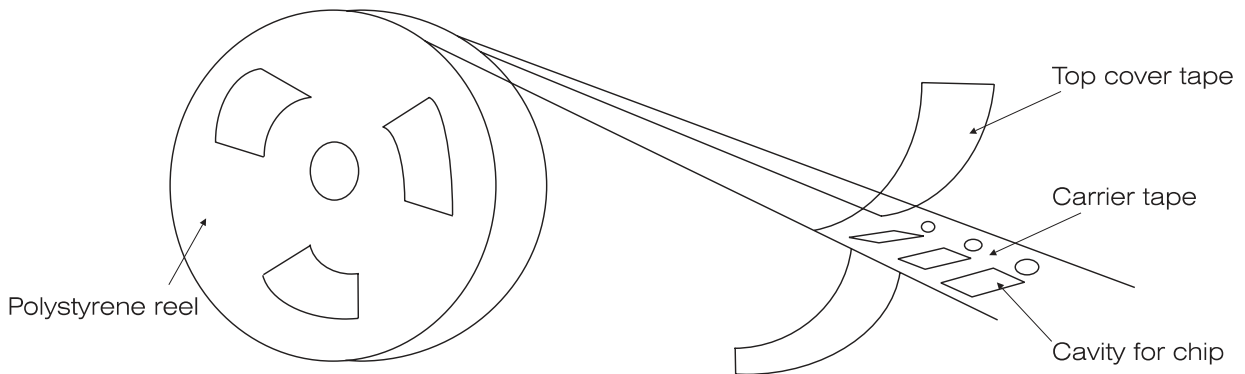

※Dimensions of embossed taping for 0805, 1206, 1210, 1808, 1812 type

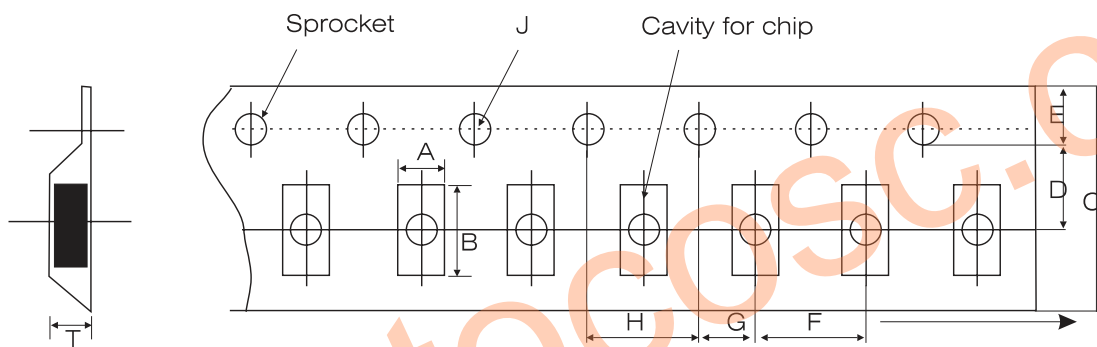

Code Tape size	A	B	C	D	E	F*	G	H	J	T
0805	1.55 ±0.20	2.35 ±0.20	8.00 ±0.20	3.50 ±0.05	1.75 ±0.10	4.00 ±0.10	2.00 ±0.10	4.00 ±0.10	1.50-0/ +0.10	低于 1.50
1206	1.95 ±0.20	3.60 ±0.20	8.00 ±0.20	3.50 ±0.05	1.75 ±0.10	4.00 ±0.10	2.00 ±0.10	4.00 ±0.10	1.50-0/ +0.10	低于 1.85
1210	2.70 ±0.10	3.42 ±0.10	8.00 ±0.10	3.50 ±0.05	1.75 ±0.10	4.00 ±0.10	2.00 ±0.05	4.00 ±0.10	1.50-0/ +0.10	低于 3.2
1808	2.20 ±0.10	4.95 ±0.10	12.00 ±0.10	5.50 ±0.05	1.75 ±0.10	4.00 ±0.10	2.00 ±0.05	4.00 ±0.10	1.50-0/ +0.10	低于 3.0
1812	3.66 ±0.10	4.95 ±0.10	12.00 ±0.10	5.50 ±0.05	1.75 ±0.10	8.00 ±0.10	2.00 ±0.05	4.00 ±0.10	1.50-0/ +0.10	低于 4.0

Note: The place with "\*" means where needs exactly dimensions.



## 多層片式陶瓷電容器

MULTILAYER CHIP CERAMIC CAPACITOR

- 傳送帶的前後結構

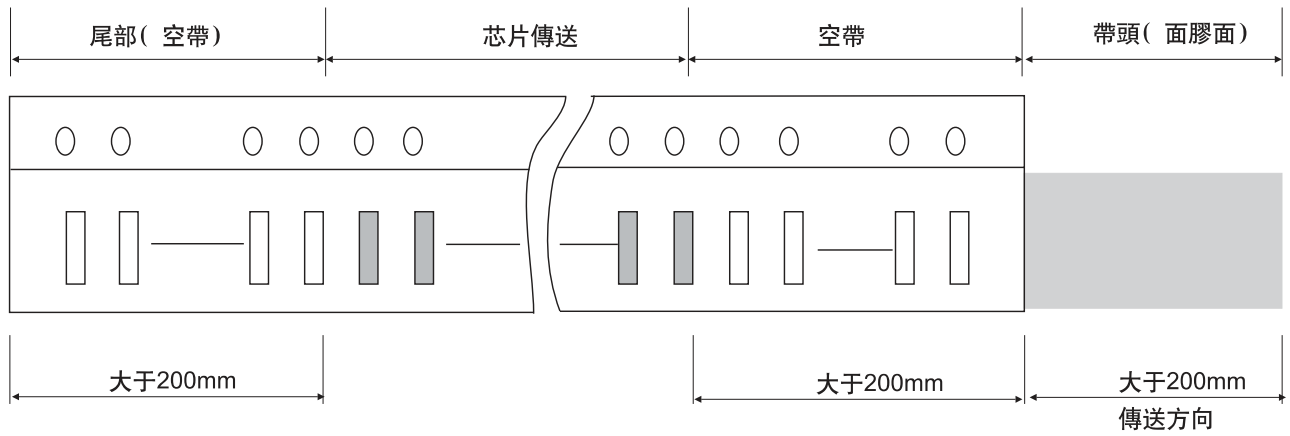

- 卷盤尺寸(單位:mm)

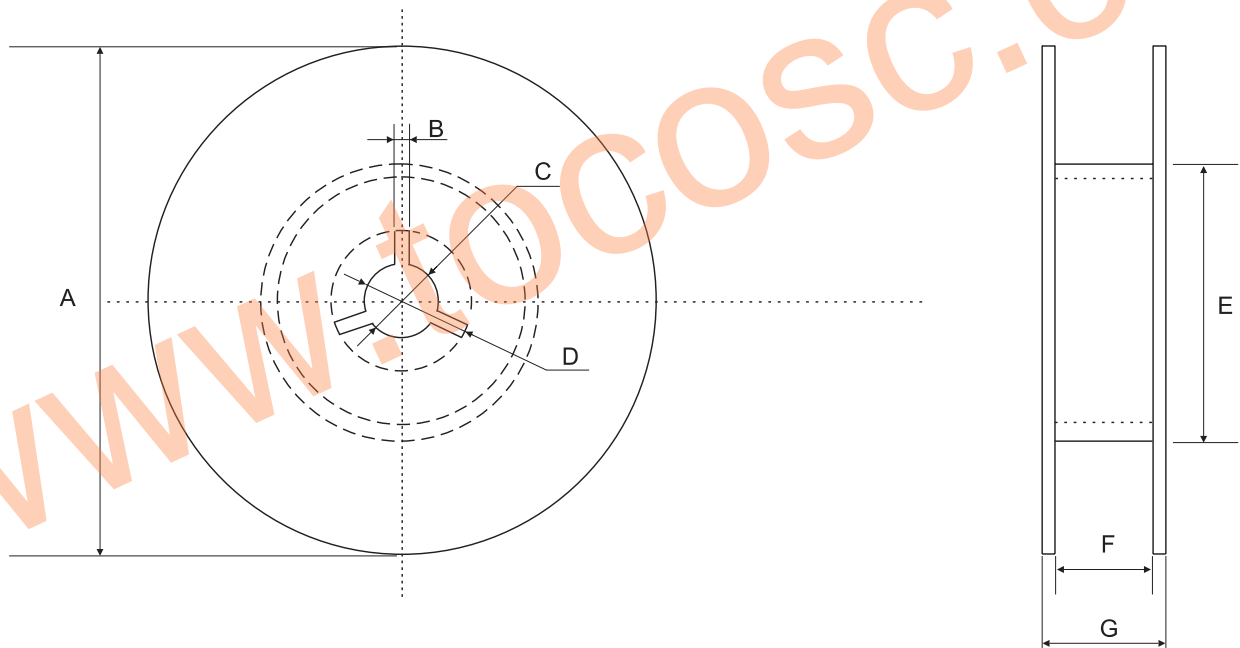

- 尺寸代碼

A	B	C	D	E	F	G
$\Phi 178.00 \pm 2.00$	3.00	$\Phi 13.00 \pm 0.50$	$\Phi 21.00 \pm 0.80$	$\Phi 50.00$ 或更大	$10.00 \pm 1.50$	12MAX
$\Phi 330.00 \pm 2.00$	3.00	$\Phi 13.00 \pm 0.50$	$\Phi 21.00 \pm 0.80$	$\Phi 50.00$ 或更大	$10.00 \pm 1.50$	12MAX

• Structure of leader part and end part of the carrier paper

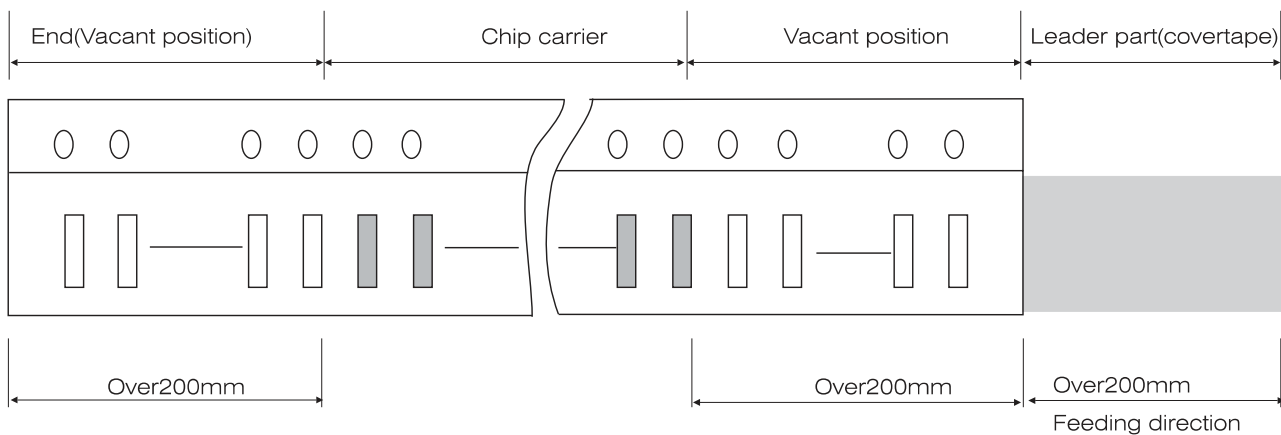

• Reel Dimensions (unit:mm)

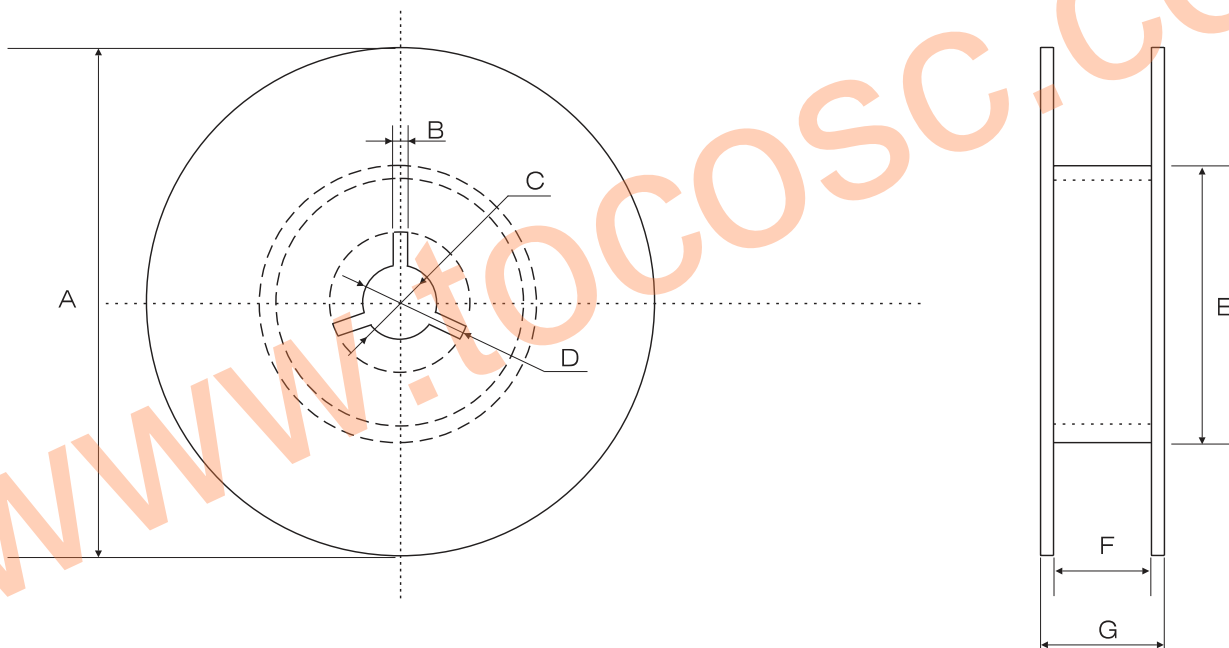

• Code

A	B	C	D	E	F	G
$\Phi 178.00 \pm 2.00$	3.00	$\Phi 13.00 \pm 0.50$	$\Phi 21.00 \pm 0.80$	$\Phi 50.00$ or max	$10.00 \pm 1.50$	12MAX
$\Phi 330.00 \pm 2.00$	3.00	$\Phi 13.00 \pm 0.50$	$\Phi 21.00 \pm 0.80$	$\Phi 50.00$ or max	$10.00 \pm 1.50$	12MAX

# 多層片式陶瓷電容器

## MULTILAYER CHIP CERAMIC CAPACITOR

### 關於卷帶的說明

#### 面膠剝離強度

(A)紙帶

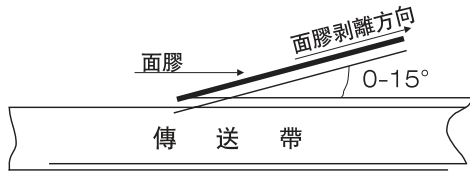

(B)塑料膠盤

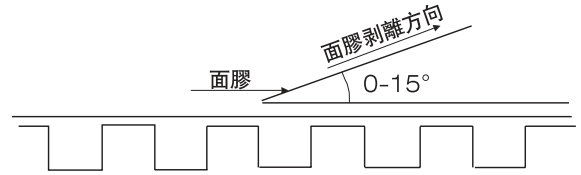

標準：0.1N<剝離強度<0.7N；在剝離時，紙帶不能有紙碎，也不能粘在底、面膠上。

#### 塑料盒散包裝

標示	A	B	T	C	D	E
尺寸	6.80±0.10	8.80±1.00	12.00±0.10	15.00+0.10/-0	2.00±0/-0.10	4.70±0.10
標示	F	W	G	H	L	I
尺寸	31.50+0.20/-0	36.00+0/-0.2	19.00±0.35	7.00±0.35	110.00±0.70	5.00±0.35

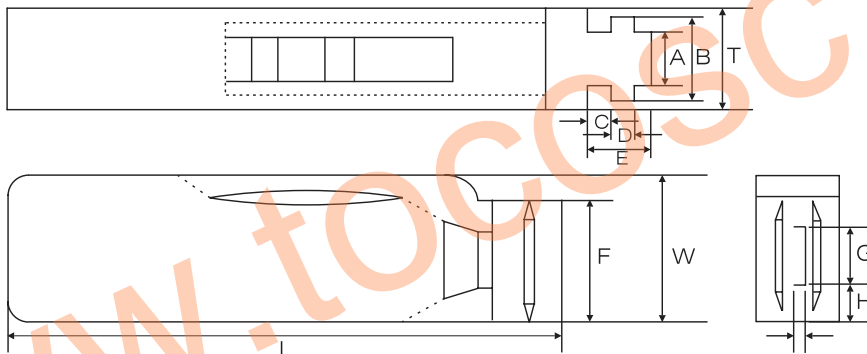

#### 包裝數量

尺寸	包裝形式和數量			
	紙帶卷盤	膠帶卷盤	塑料盒散裝	一般散裝
0402	10000		20000	5000
0603	4000		15000	5000
0805	4000	3000	10000	5000
1206	4000	T≤1.35mm 3000 T>1.35mm 2000	5000	5000
1210		T≤1.80mm 2000 T>1.80mm 1000		2000
1808		2000		2000
1812		T≤1.85mm 1000 T>1.85mm 500		2000
2225		500		500
3035		500		

注意：包裝的形式和數量可根據客戶的要求來定。

## ■ TAPING SPECIFICATION

- Top cover tape peeling strength

(A) Paper Taping

(b) Cover tape peeling direction

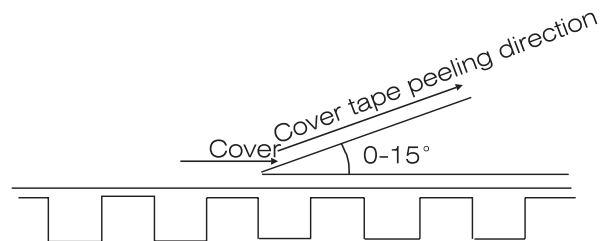
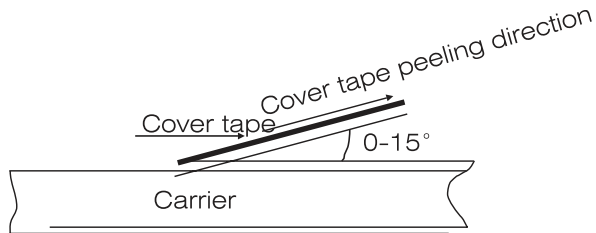

Standard:  $0.1N < \text{peeling forc} < 0.7N$ ;

No paper dirty remains on the scotch when peeling, and no sticks to top and bottom cover tape.

- Bulk Case Package

Symbol	A	B	T	C	D	E
Dimension	$6.80 \pm 0.10$	$8.80 \pm 1.00$	$12.00 \pm 0.10$	$15.00 + 0.10 / -1$	$2.00 \pm 0 / -0.10$	$4.70 \pm 0.10$
Symol	F	W	G	H	L	I
Dimension	$31.50 + 0.20 / -0$	$36.00 + 0 / -0.2$	$19.00 \pm 0.35$	$7.00 \pm 0.35$	$110.00 \pm 0.70$	$5.00 \pm 0.35$

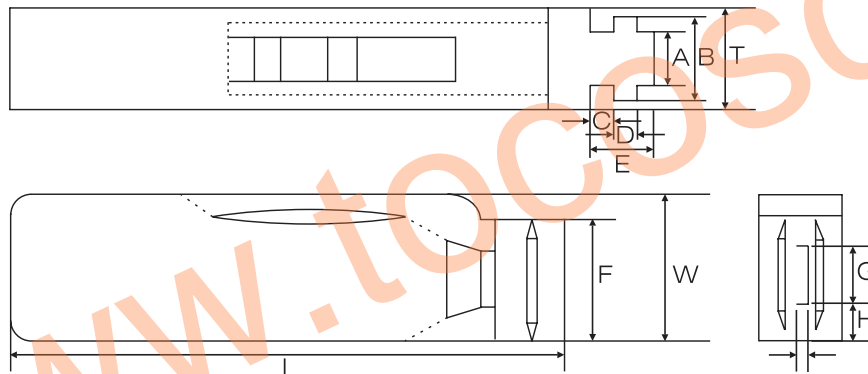

- Pack Quantity

Size	Pakaging method and quantity			
	Paper tape taping	Plastic embossed taping	Bulk plastic box packaging	Normal bulk packaging
0402	10000		20000	5000
0603	4000		15000	5000
0805	4000	3000	10000	5000
1206	4000	$T \leq 1.35\text{mm}$ 3000 $T > 1.35\text{mm}$ 2000	5000	5000
1210		$T \leq 1.80\text{mm}$ 2000 $T > 1.80\text{mm}$ 1000		2000
1808		2000		2000
1812		$T \leq 1.85\text{mm}$ 1000 $T > 1.85\text{mm}$ 500		2000
2225		500		500
3035		500		

Note: We can choose packing style and quantity can be according to the customer's requirement.

■ 通用型片式電容使用注意事項

階段	預防	注意事項																																																																															
1 綫路設計	<p>使用環境的確認： 醫療器械、航空用器、原子彈反應器如果出現故障，會對人的生命和整個社會造成巨大的損壞。因此用于這些設備的電容器必須具有很高的可靠性和安全性，并且比用于普通應用的電容器元件的要求更高，其區別也很明顯。</p>	<p>電子額定系數和性能的工作電壓（額定電壓的確認）</p> <ol style="list-style-type: none"> <li>1. 電容器的工作電壓應比其額定電壓低。如果在一DC電壓上加載一個AC電壓，那么兩個峰值電壓之和應小于所選擇的電容器的額定值。對於同時使用AC電壓和脈衝電壓的電路，它們的峰值電壓之和也應低于電容器的額定電壓。</li> <li>2. 甚至在供給的電壓低于額定電壓值時，如果電路中使用的高頻AC電壓或脈衝電壓升高的時間過快，那么電容器的性能會因此被減弱。</li> </ol>																																																																															
2. PCB板的設計	<p>基板配置（墊板的設計）</p> <p>當電容器被安裝在PCB板上后，所使用的焊料的量（焊盤的大小）會直接影響電容器的性能。因此在設計焊盤時必須考慮到以下幾點：</p> <ol style="list-style-type: none"> <li>1. 所用焊料的量的大小會影響芯片抗機械應力的能力，從而可能導致電容器破碎或開裂。因此在設計基板時，必須慎重考慮焊盤的大小和配置，這些對組成基板的焊料的量有着決定的作用。</li> <li>2. 如果不止一個元件被連續焊接在同一基板或焊盤上時，焊盤的設計應可以使每個元件的焊接點被阻焊區隔離開。</li> </ol>	<p>以下圖表為所推薦使用的墊板以防止過量的焊料量(基板較大時會超出元件的端頭)同時也給出了不合理的基板設計圖。</p> <p>以下為推薦使用的PCB上焊盤的尺寸</p> <p>推薦用于波峰焊接的焊盤尺寸（單位：mm）</p> <table border="1"> <thead> <tr> <th>類型</th> <th>0603</th> <th>0805</th> <th>1206</th> <th>1210</th> </tr> </thead> <tbody> <tr> <td rowspan="2">尺寸</td> <td>L</td> <td>1.60</td> <td>2.00</td> <td>3.20</td> <td>3.20</td> </tr> <tr> <td>W</td> <td>0.80</td> <td>1.25</td> <td>1.60</td> <td>2.5</td> </tr> <tr> <td>A</td> <td>0.8~1.0</td> <td>1.0~1.4</td> <td>1.8~2.5</td> <td>1.8~2.5</td> </tr> <tr> <td>B</td> <td>0.5~0.8</td> <td>0.8~1.5</td> <td>0.8~1.7</td> <td>0.8~1.7</td> </tr> <tr> <td>C</td> <td>0.6~0.8</td> <td>0.9~1.2</td> <td>1.2~1.6</td> <td>1.8~2.5</td> </tr> </tbody> </table> <p>推薦用于回流焊接的焊盤尺寸（單位：mm）</p> <table border="1"> <thead> <tr> <th>類型</th> <th>0402</th> <th>0603</th> <th>0805</th> <th>1206</th> <th>1210</th> <th>1812</th> <th>2225</th> </tr> </thead> <tbody> <tr> <td rowspan="2">尺寸</td> <td>L</td> <td>1.10</td> <td>1.60</td> <td>2.00</td> <td>3.20</td> <td>3.20</td> <td>5.70</td> </tr> <tr> <td>W</td> <td>0.50</td> <td>0.80</td> <td>1.25</td> <td>1.60</td> <td>2.50</td> <td>3.20</td> <td>6.30</td> </tr> <tr> <td>A</td> <td>0.45~0.55</td> <td>0.6~0.8</td> <td>0.8~1.2</td> <td>1.8~2.5</td> <td>1.8~2.5</td> <td>2.5~3.5</td> <td>3.7~4.7</td> </tr> <tr> <td>B</td> <td>0.40~0.50</td> <td>0.6~0.8</td> <td>0.6~1.2</td> <td>0.6~1.5</td> <td>0.6~1.5</td> <td>1.0~1.8</td> <td>1.0~2.3</td> </tr> <tr> <td>C</td> <td>0.45~0.55</td> <td>0.6~0.8</td> <td>0.9~1.6</td> <td>1.2~2.0</td> <td>1.8~3.2</td> <td>2.3~3.5</td> <td>3.5~5.5</td> </tr> </tbody> </table> <p>過量的焊料會影響芯片耐機械應力的能力。因此在設計基板時，需注意這些。</p>	類型	0603	0805	1206	1210	尺寸	L	1.60	2.00	3.20	3.20	W	0.80	1.25	1.60	2.5	A	0.8~1.0	1.0~1.4	1.8~2.5	1.8~2.5	B	0.5~0.8	0.8~1.5	0.8~1.7	0.8~1.7	C	0.6~0.8	0.9~1.2	1.2~1.6	1.8~2.5	類型	0402	0603	0805	1206	1210	1812	2225	尺寸	L	1.10	1.60	2.00	3.20	3.20	5.70	W	0.50	0.80	1.25	1.60	2.50	3.20	6.30	A	0.45~0.55	0.6~0.8	0.8~1.2	1.8~2.5	1.8~2.5	2.5~3.5	3.7~4.7	B	0.40~0.50	0.6~0.8	0.6~1.2	0.6~1.5	0.6~1.5	1.0~1.8	1.0~2.3	C	0.45~0.55	0.6~0.8	0.9~1.6	1.2~2.0	1.8~3.2	2.3~3.5	3.5~5.5
類型	0603	0805	1206	1210																																																																													
尺寸	L	1.60	2.00	3.20	3.20																																																																												
	W	0.80	1.25	1.60	2.5																																																																												
A	0.8~1.0	1.0~1.4	1.8~2.5	1.8~2.5																																																																													
B	0.5~0.8	0.8~1.5	0.8~1.7	0.8~1.7																																																																													
C	0.6~0.8	0.9~1.2	1.2~1.6	1.8~2.5																																																																													
類型	0402	0603	0805	1206	1210	1812	2225																																																																										
尺寸	L	1.10	1.60	2.00	3.20	3.20	5.70																																																																										
	W	0.50	0.80	1.25	1.60	2.50	3.20	6.30																																																																									
A	0.45~0.55	0.6~0.8	0.8~1.2	1.8~2.5	1.8~2.5	2.5~3.5	3.7~4.7																																																																										
B	0.40~0.50	0.6~0.8	0.6~1.2	0.6~1.5	0.6~1.5	1.0~1.8	1.0~2.3																																																																										
C	0.45~0.55	0.6~0.8	0.9~1.6	1.2~2.0	1.8~3.2	2.3~3.5	3.5~5.5																																																																										









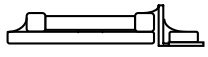
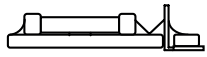
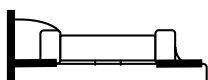
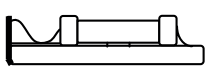
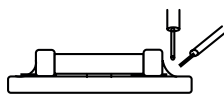
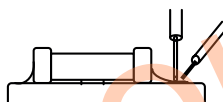
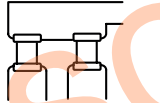
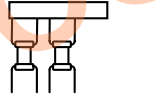
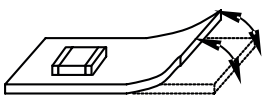
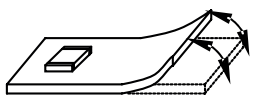
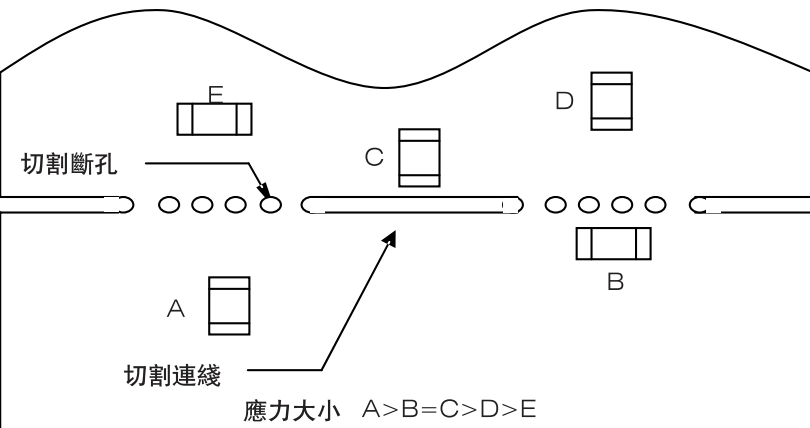
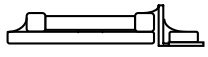
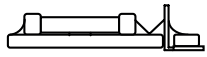
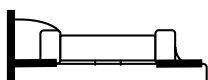
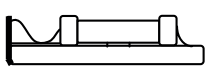
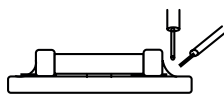
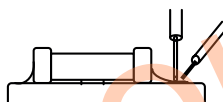
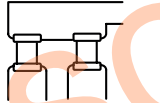
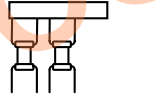
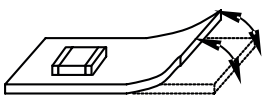
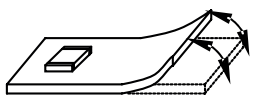
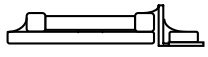
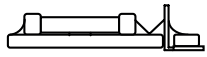
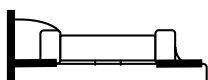
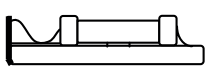
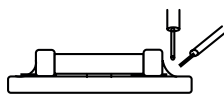
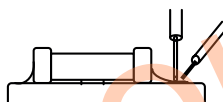
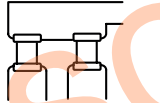
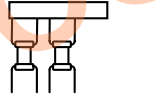
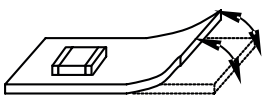
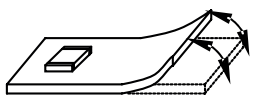

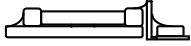

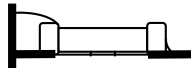
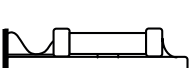
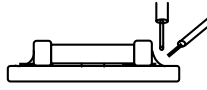
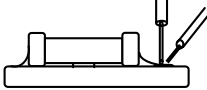
## ■ Precautions for the use of general MLCC

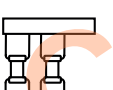
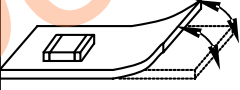
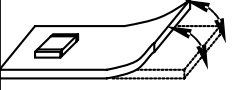
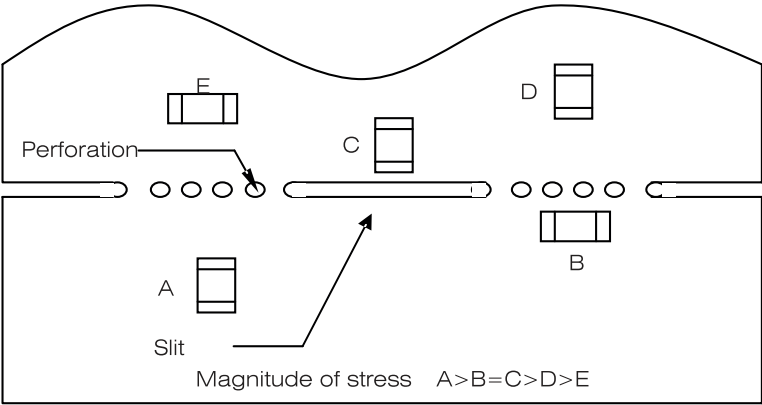
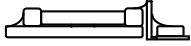
Stages	Precaution	Technical considerations																																																																																
1. Circuit Design	<p>Verification of operating environment:</p> <p>If there were any malfunction in medical equipment, spacecraft or nuclear reactors, etc. it will causes serious damage to human life or social ramifications. For this reason , any capacitors to be used in such equipments must have very high safety and reliability considerations and must have high requirements than capacitor normal for applications.</p>	<p>Electrical rating and performance:</p> <p>Operating Voltage (Verification of Rated voltage)</p> <p>1. The operating voltage for capacitors must always be lower than their rated values.</p> <p>If an AC voltage is loaded on a DC voltage, the sum of the two peak voltages should be lower than the rated value of the capacitor chosen. For a circuit where both an AC and a pulse voltage may be present, the sum of their peak voltages should also be lower than the capacitor's rated voltage.</p> <p>2. Even if the applied voltage is lower than the rated value, the reliability of capacitors might be reduced if either a high frequency AC voltage or a pulse voltage having rapid rise time is present in the circuit.</p>																																																																																
2. PCB Design	<p>Pattern configurations (Design of Land-patterns)</p> <p>When capacitors are mounted on a PCB, the amount of solder used (size of fillet) can directly affect capacitor performance. Therefore, the following items must be carefully considered in the design of solder land patterns:</p> <p>(1)The amount of solder applied can affect the ability of chips to withstand mechanical stresses, which may lead to breaking or cracking. Therefore, when designing land-patterns it is necessary to consider the appropriate size and configuration of the solder pads, which determines the amount of solder necessary to form the fillets.</p> <p>(2) When more than one part is jointly soldered onto the same land or pad, the pad must be designed so that each components soldering point is separated by soldering-resist.</p>	<p>1. The following diagrams and tables show some examples of recommended patterns to prevent excessive solder amounts (larger fillets will extend above the components end terminations). Examples of improper pattern designs are also shown.</p> <p>Recommended land dimensions for PCB</p> <p>Recommend land dimensions for wave-soldering (unit: mm)</p> <table border="1"> <thead> <tr> <th>Type</th> <th>0603</th> <th>0805</th> <th>1206</th> <th>1210</th> </tr> </thead> <tbody> <tr> <td rowspan="2">Size</td> <td>L</td> <td>1.60</td> <td>2.00</td> <td>3.20</td> <td>3.20</td> </tr> <tr> <td>W</td> <td>0.80</td> <td>1.25</td> <td>1.60</td> <td>2.50</td> </tr> <tr> <td>A</td> <td>0.80~1.00</td> <td>1.00~1.40</td> <td>1.80~2.50</td> <td>1.80~2.50</td> </tr> <tr> <td>B</td> <td>0.50~0.80</td> <td>0.80~1.50</td> <td>0.80~1.70</td> <td>0.80~1.70</td> </tr> <tr> <td>C</td> <td>0.60~0.80</td> <td>0.90~1.20</td> <td>1.20~1.60</td> <td>1.80~2.50</td> </tr> </tbody> </table> <p>Recommend land dimensions for reflow-soldering (unit: mm)</p> <table border="1"> <thead> <tr> <th>Type</th> <th>0402</th> <th>0603</th> <th>0805</th> <th>1206</th> <th>1210</th> <th>1812</th> <th>2225</th> </tr> </thead> <tbody> <tr> <td rowspan="2">Size</td> <td>L</td> <td>1.00</td> <td>1.60</td> <td>2.00</td> <td>3.20</td> <td>3.20</td> <td>4.50</td> <td>5.70</td> </tr> <tr> <td>W</td> <td>0.50</td> <td>0.80</td> <td>1.25</td> <td>1.60</td> <td>2.50</td> <td>3.20</td> <td>6.30</td> </tr> <tr> <td>A</td> <td>0.45~0.55</td> <td>0.6~0.8</td> <td>0.8~1.2</td> <td>1.8~2.5</td> <td>1.8~2.5</td> <td>2.5~3.5</td> <td>3.7~4.7</td> </tr> <tr> <td>B</td> <td>0.40~0.50</td> <td>0.6~0.8</td> <td>0.6~1.2</td> <td>0.6~1.5</td> <td>0.6~1.5</td> <td>1.0~1.8</td> <td>1.0~2.3</td> </tr> <tr> <td>C</td> <td>0.45~0.55</td> <td>0.6~0.8</td> <td>0.9~1.6</td> <td>1.2~2.0</td> <td>1.8~3.2</td> <td>2.3~3.5</td> <td>3.5~5.5</td> </tr> </tbody> </table> <p>Excess solder can affect the ability of chips to withstand mechanical stresses. Therefore, please take proper precautions when designing land-patterns.</p>	Type	0603	0805	1206	1210	Size	L	1.60	2.00	3.20	3.20	W	0.80	1.25	1.60	2.50	A	0.80~1.00	1.00~1.40	1.80~2.50	1.80~2.50	B	0.50~0.80	0.80~1.50	0.80~1.70	0.80~1.70	C	0.60~0.80	0.90~1.20	1.20~1.60	1.80~2.50	Type	0402	0603	0805	1206	1210	1812	2225	Size	L	1.00	1.60	2.00	3.20	3.20	4.50	5.70	W	0.50	0.80	1.25	1.60	2.50	3.20	6.30	A	0.45~0.55	0.6~0.8	0.8~1.2	1.8~2.5	1.8~2.5	2.5~3.5	3.7~4.7	B	0.40~0.50	0.6~0.8	0.6~1.2	0.6~1.5	0.6~1.5	1.0~1.8	1.0~2.3	C	0.45~0.55	0.6~0.8	0.9~1.6	1.2~2.0	1.8~3.2	2.3~3.5	3.5~5.5
Type	0603	0805	1206	1210																																																																														
Size	L	1.60	2.00	3.20	3.20																																																																													
	W	0.80	1.25	1.60	2.50																																																																													
A	0.80~1.00	1.00~1.40	1.80~2.50	1.80~2.50																																																																														
B	0.50~0.80	0.80~1.50	0.80~1.70	0.80~1.70																																																																														
C	0.60~0.80	0.90~1.20	1.20~1.60	1.80~2.50																																																																														
Type	0402	0603	0805	1206	1210	1812	2225																																																																											
Size	L	1.00	1.60	2.00	3.20	3.20	4.50	5.70																																																																										
	W	0.50	0.80	1.25	1.60	2.50	3.20	6.30																																																																										
A	0.45~0.55	0.6~0.8	0.8~1.2	1.8~2.5	1.8~2.5	2.5~3.5	3.7~4.7																																																																											
B	0.40~0.50	0.6~0.8	0.6~1.2	0.6~1.5	0.6~1.5	1.0~1.8	1.0~2.3																																																																											
C	0.45~0.55	0.6~0.8	0.9~1.6	1.2~2.0	1.8~3.2	2.3~3.5	3.5~5.5																																																																											

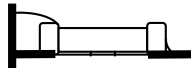
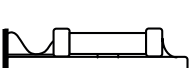
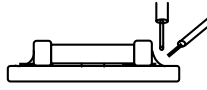
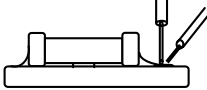
# 多層片式陶瓷電容器

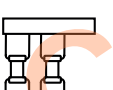
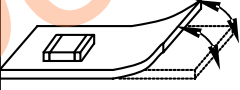
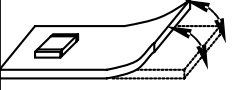
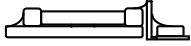
## MULTILAYER CHIP CERAMIC CAPACITOR

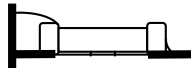
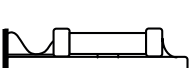
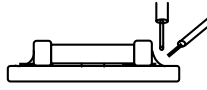
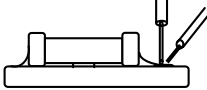

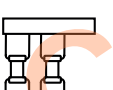
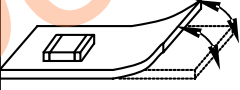
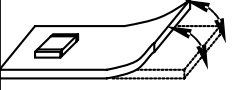



階段	預防	注意事項																					
	<p>基板配置 (電容器在儀器 (分割) PCB板上的安裝設計) 將電容器安裝在板上之后, 芯片將承受在下一加工過程中產生的機械應力 (PCB的切割, 板的檢驗、其它部件的安裝, 裝配到底盤、波峰焊接回流焊板, 等)。出于這個原因, 在設計焊盤和 SMD電容器的位置時, 應注意考慮將應力減到最低點。</p>	<p>焊料用量好與差的例子如下:</p> <table border="1" data-bbox="635 347 1465 1120"> <thead> <tr> <th>項目</th> <th>不推薦</th> <th>推薦</th> </tr> </thead> <tbody> <tr> <td>混合安裝 SMD 和引線元件</td> <td></td> <td></td> </tr> <tr> <td>靠近底盤的元件的安裝</td> <td></td> <td></td> </tr> <tr> <td>在已安裝元件的附近手工焊接引線元件</td> <td></td> <td></td> </tr> <tr> <td>水平安裝元件</td> <td></td> <td></td> </tr> </tbody> </table> <p>1. 下圖示為電容器在PCB板上布局好壞的例子: PCB板彎曲變形時產生應力, 應將電容器安裝在 PCB板上的受影響最小的位置。</p> <table border="1" data-bbox="635 1254 1465 1456"> <thead> <tr> <th></th> <th>不推薦</th> <th>推薦</th> </tr> </thead> <tbody> <tr> <td>板的變形</td> <td></td> <td></td> </tr> </tbody> </table> <p>2. 電容器安裝在切割PCB板上時, 電容器所受機械應力的由電容器的布局而定。以下為推薦使用的布局方式:</p> <div data-bbox="646 1556 1460 1982">  <p>切割斷孔</p> <p>切割連線</p> <p>應力大小 <math>A &gt; B = C &gt; D &gt; E</math></p> </div>	項目	不推薦	推薦	混合安裝 SMD 和引線元件			靠近底盤的元件的安裝			在已安裝元件的附近手工焊接引線元件			水平安裝元件				不推薦	推薦	板的變形		
項目	不推薦	推薦																					
混合安裝 SMD 和引線元件																							
靠近底盤的元件的安裝																							
在已安裝元件的附近手工焊接引線元件																							
水平安裝元件																							
	不推薦	推薦																					
板的變形																							





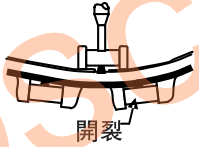
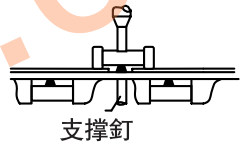

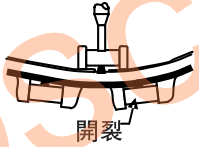
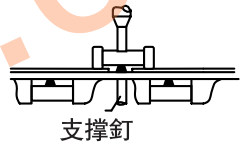

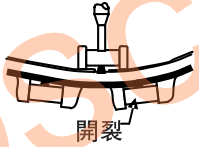
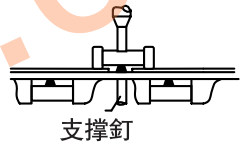

Stages	Precautions	Technical considerations																					
	<p>Pattern configurations (Capacitor layout on panelized [breakaway] PC boards)</p> <p>After capacitors have been mounted on the boards, chips can be subjected to mechanical stresses in subsequent manufacturing processes (PCB cutting, board inspection, mounting of additional parts, assembly into the chassis, wave soldering the reflow-soldering boards etc.). For this reason, planning pattern configurations and the position of SMD capacitors should be carefully performed to minimize stress.</p>	<p>Examples of good and bad solder application.</p> <table border="1" data-bbox="592 360 1358 1021"> <thead> <tr> <th>Items</th> <th>Not recommended</th> <th>Recommended</th> </tr> </thead> <tbody> <tr> <td>Mixed mounting of SMD and leaded components</td> <td></td> <td></td> </tr> <tr> <td>Component placement close to the chassis</td> <td></td> <td></td> </tr> <tr> <td>Hand soldering of leaded components near mounted components</td> <td></td> <td></td> </tr> <tr> <td>Horizontal component placement</td> <td></td> <td></td> </tr> </tbody> </table> <p>1.The following are examples of good and bad capacitor layout: SMD capacitors should be located to minimize any possible mechanical stresses from board warp or deflection.</p> <table border="1" data-bbox="592 1167 1262 1413"> <thead> <tr> <th></th> <th>Not recommended</th> <th>Recommended</th> </tr> </thead> <tbody> <tr> <td>Deflection of the board</td> <td></td> <td></td> </tr> </tbody> </table> <p>2.To layout the capacitors for the breakaway PC board, it should be noted that the amount of mechanics stresses given will vary depending on capacitor layout, The example below shows recommendations for better design.</p>  <p>Magnitude of stress <math>A &gt; B = C &gt; D &gt; E</math></p>	Items	Not recommended	Recommended	Mixed mounting of SMD and leaded components			Component placement close to the chassis			Hand soldering of leaded components near mounted components			Horizontal component placement				Not recommended	Recommended	Deflection of the board		
Items	Not recommended	Recommended																					
Mixed mounting of SMD and leaded components																							
Component placement close to the chassis																							
Hand soldering of leaded components near mounted components																							
Horizontal component placement																							
	Not recommended	Recommended																					
Deflection of the board																							

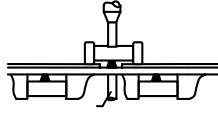

## 多層片式陶瓷電容器

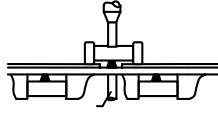
### MULTILAYER CHIP CERAMIC CAPACITOR

階段	預防	注意事項									
		<p>3.PCB板沿着接縫孔切割開時，電容器所受機械應力的大小因使用的方法不同而不同。以下方法按應力從小到大進行排列：推板、割裂、V形凹槽、接縫孔。因此，任何理想的SMD電容器的布局必須考慮到PCB板的分割方法。</p>									
<p>3. 自動安裝應考慮到的問題</p>	<p>調節安裝機器： 在將電容器安裝在PCB板上時，不能讓電容器承受過量的衝擊力。應定期對安裝機器進行維修和檢查。</p>	<p>1. 如果吸拾管降低的位置超過最低限位，就會對電容器產生過大的壓力，從而導致電容器破裂。為了避免上述現象的發生，在降低吸拾管時，要注意以下各點：</p> <ol style="list-style-type: none"> <li>(1) 在校正PCB板的偏差后，應將吸拾管的最低限位調節到PCB板的表面水平位置。</li> <li>(2) 吸拾壓力應調節至1到3N之間。</li> <li>(3) 為了減少吸拾管衝擊力導致PCB板的變形程度，支撐釘應放在PCB板的下方。下圖有吸拾管安裝較好的例子。</li> </ol> <table border="1" data-bbox="635 763 1449 1182"> <thead> <tr> <th data-bbox="635 763 882 837"></th> <th data-bbox="882 763 1161 837">不推薦使用</th> <th data-bbox="1161 763 1449 837">推薦使用</th> </tr> </thead> <tbody> <tr> <td data-bbox="635 837 882 1003">單面安裝</td> <td data-bbox="882 837 1161 1003">  </td> <td data-bbox="1161 837 1449 1003">  </td> </tr> <tr> <td data-bbox="635 1003 882 1182">雙面安裝</td> <td data-bbox="882 1003 1161 1182">  </td> <td data-bbox="1161 1003 1449 1182">  </td> </tr> </tbody> </table> <p>2. 如果對位釘磨損，吸管的調整會致使電容器受到機械應力的衝擊而缺口或開裂。為了避免這種現象的發生，在對處於停止狀態下對位釘間寬度和支撐釘進行定期的檢查、維修、檢驗和更換。</p>		不推薦使用	推薦使用	單面安裝			雙面安裝		
	不推薦使用	推薦使用									
單面安裝											
雙面安裝											

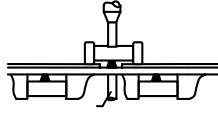
Stages	Precautions	Technical considerations									
		<p>3. When breaking PC boards along their perforations, the amount of mechanical stress on the capacitors can vary according to the method used. The following methods are listed in order from least stressful to most stressful: push-back, slit, V-grooving, and perforation. Thus, any ideal SMD capacitor layout must also consider the PCB splitting method.</p>									
<p>3. Considerations for automatic placement</p>	<p>Adjustment of mounting machine Excessive impact load should not be imposed on the capacitors when mounting onto the PC boards. The maintenance and inspection of the mounting devices must minimize the stresses..</p>	<p>1. If the pick-up nozzle is lower than the low limit, too much force may be imposed on the capacitors, causing damage. To avoid this, the following points should be considered before lowering the pick-up nozzle:</p> <ol style="list-style-type: none"> <li>(1) The lower limit of the pick-up nozzle should be adjusted to the surface level of the PC board after correcting for deflection of the board.</li> <li>(2) The pick-up pressure should be adjusted between 1 and 3 N static loads.</li> <li>(3) To reduce the amount of deflection of the board caused by impact of the pick-up nozzle, supporting pins of back-up should be used the under PC board. The following diagrams show some typical examples of good pick-up nozzle placement:</li> </ol> <table border="1" data-bbox="587 949 1385 1330"> <thead> <tr> <th data-bbox="587 949 826 994"></th> <th data-bbox="826 949 1086 994">Not recommended</th> <th data-bbox="1086 949 1385 994">Recommended</th> </tr> </thead> <tbody> <tr> <td data-bbox="587 994 826 1160">Single-sided mounting</td> <td data-bbox="826 994 1086 1160">  <p>Cracks</p> </td> <td data-bbox="1086 994 1385 1160">  <p>Supporting pin</p> </td> </tr> <tr> <td data-bbox="587 1160 826 1330">Double-sided mounting</td> <td data-bbox="826 1160 1086 1330">  <p>Solder peaking Cracks</p> </td> <td data-bbox="1086 1160 1385 1330">  <p>Supporting pin</p> </td> </tr> </tbody> </table> <p>2. As the alignment pin wears out, adjustment of the nozzle height can cause chipping or cracking of the capacitors because of mechanical impact on the capacitors. To avoid this, should have periodically inspection, maintenance, repair and change about the alignment pin width and supporting pins, and all this actions should be done under stopped position.</p>		Not recommended	Recommended	Single-sided mounting	 <p>Cracks</p>	 <p>Supporting pin</p>	Double-sided mounting	 <p>Solder peaking Cracks</p>	 <p>Supporting pin</p>
	Not recommended	Recommended									
Single-sided mounting	 <p>Cracks</p>	 <p>Supporting pin</p>									
Double-sided mounting	 <p>Solder peaking Cracks</p>	 <p>Supporting pin</p>									

## 多層片式陶瓷電容器

### MULTILAYER CHIP CERAMIC CAPACITOR

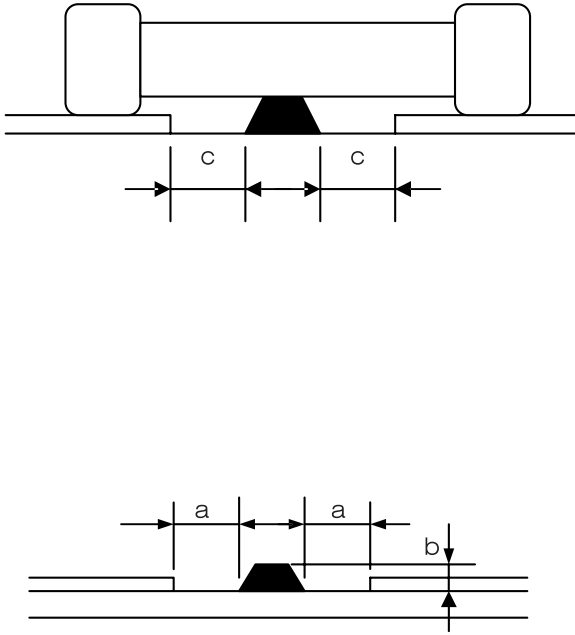
階段	預防	注意事項								
<p>3.自動安裝應考慮到的問題</p>	<p>粘着劑的選用： 在焊接安裝電容器之前，用粘着劑將電容器固定在基板上，這將導致電容器的特性降級，除非對以下因素進行合理的檢查：基板的大小、粘着劑的類型和用量、硬化的溫度和時間。因此，用戶在使用粘着劑時，要注意其用法和用量。</p>	<p>1. 一些粘着劑會減少電容器的絕緣。粘着劑和電容器收縮率的不同會在電容器上產生應力并導致開裂。甚至板上過多或過少的粘着劑會影響元件的安裝。因此在使用粘着劑時應注意以下事項：</p> <p>(1) 要求粘着劑具有的特性：</p> <ol style="list-style-type: none"> <li>在安裝和焊接過程中，粘着劑應有足夠大的力來支撐板上的元件。</li> <li>粘着劑在高溫下要有充足的強度。</li> <li>粘着劑要有很好的粘稠度</li> <li>粘着劑應在其使用期限前使用</li> <li>粘着劑可快速硬化。</li> <li>粘着劑不能被雜質污染</li> <li>粘着劑要有很好的絕緣特性</li> <li>粘着劑不能有有毒或不能發出有毒的氣體。</li> </ol> <table border="1" data-bbox="663 904 1441 1077"> <thead> <tr> <th>序號</th> <th>以 0805/1206 尺寸為例</th> </tr> </thead> <tbody> <tr> <td>a</td> <td>最小 0.3 mm</td> </tr> <tr> <td>b</td> <td>100~120 μm</td> </tr> <tr> <td>c</td> <td>粘着劑不能接觸到焊區</td> </tr> </tbody> </table> <p style="text-align: center;">電容固化后</p> 	序號	以 0805/1206 尺寸為例	a	最小 0.3 mm	b	100~120 μm	c	粘着劑不能接觸到焊區
序號	以 0805/1206 尺寸為例									
a	最小 0.3 mm									
b	100~120 μm									
c	粘着劑不能接觸到焊區									

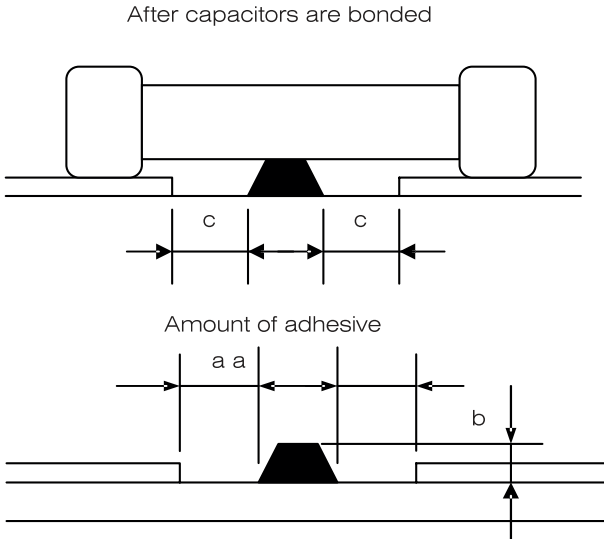
Stages	Precautions	Technical considerations								
<p>3. Considerations for automatic placement</p>	<p>Selection of Adhesives</p> <p>1. Mounting capacitors with adhesives in land patterns, before the soldering stage, may lead to degraded capacitor characteristics unless the following factors are appropriately checked: the size of land patterns, type of adhesive, amount applied, hardening temperature and hardening period. Therefore, users must pay attention to the using method and using amount of adhesives during using the adhesives.</p>	<p>1. Some adhesives may cause reduced insulation resistance, The difference between the shrinkage percentage of the adhesive and that of the capacitors may result in stresses on the capacitors and lead to cracking. Moreover, too little or too much adhesive applied to the board may adversely affect component placement, so the following precautions should be noted in the application of adhesives.</p> <p>(1) Required adhesive characteristics</p> <ol style="list-style-type: none"> <li>The adhesive should be strong enough to hold parts on the board during the mounting &amp; solder process.</li> <li>The adhesive should have sufficient strength at high temperatures.</li> <li>The adhesive should have good coating and thickness consistency.</li> <li>The adhesive should be used during its prescribed shelf life.</li> <li>The adhesive should harden rapidly.</li> <li>The adhesive must not be contaminated.</li> <li>The adhesive should have excellent insulation characteristics.</li> <li>The adhesive should not be toxic and have no emission of toxic gasses.</li> </ol> <p>2. The recommended amount of adhesives is as follows.</p> <table border="1" data-bbox="635 1151 1347 1323"> <thead> <tr> <th>Figure</th> <th>0805/1206 case sizes as examples</th> </tr> </thead> <tbody> <tr> <td>a</td> <td>0.3 mm min</td> </tr> <tr> <td>b</td> <td>100~120 <math>\mu</math>m</td> </tr> <tr> <td>c</td> <td>Adhesives should not contact the pad</td> </tr> </tbody> </table> <div style="text-align: center;"> <p>After capacitors are bonded</p>  </div>	Figure	0805/1206 case sizes as examples	a	0.3 mm min	b	100~120 $\mu$ m	c	Adhesives should not contact the pad
Figure	0805/1206 case sizes as examples									
a	0.3 mm min									
b	100~120 $\mu$ m									
c	Adhesives should not contact the pad									

## 多層片式陶瓷電容器

### MULTILAYER CHIP CERAMIC CAPACITOR

階段	預防	注意事項																																																																																															
4. 焊接		<p>1. 活化助焊劑中的鹵化物過多或使用了高酸性的助焊劑，那麼焊接後過多的殘留物會腐蝕電容器端頭電極或降解電容器表面的絕緣。</p> <p>2. 流焊接過程中使用助焊劑是為了增強電容器的可焊性，但如使用過多的助焊劑，助焊劑大量的霧氣會射到電容器上，從而使電容器可焊性受到破壞性的影響。應盡可能減少助焊劑的用量，推薦使用助焊劑氣泡體系。</p> <p>3. 由於溶水性助焊劑的殘留物易溶于空氣中的水，因此高濕條件下電容器表面上的殘留物會導致電容器絕緣下降並影響電容器的可靠性。當選用了溶水性助焊劑時，要特別留意清洗方法和所使用的機器的能力。</p> <p>焊接時的預熱處理：            加熱：在焊接前應對片式陶瓷元件在 100 到 130°C 下預熱。            冷卻：元件和清洗過程中的溫度差異不能大於 100°C。當陶瓷片式電容器曝放在快速或集中致熱或快速致冷的條件下，會受到熱衝擊的影響。因此在焊接過程中要特別注意防止電容器受到過量熱衝擊的影響。</p> <p>推薦使用的焊接方式</p>																																																																																															
		<table border="1"> <thead> <tr> <th>規格尺寸</th> <th>溫度特性</th> <th>額定電壓</th> <th>容量範圍</th> <th>焊接方法</th> </tr> </thead> <tbody> <tr> <td rowspan="3">0201</td> <td>NPO</td> <td>/</td> <td></td> <td>R</td> </tr> <tr> <td>X7R</td> <td>/</td> <td></td> <td>R</td> </tr> <tr> <td>Y5V</td> <td>/</td> <td></td> <td>R</td> </tr> <tr> <td rowspan="3">0402</td> <td>NPO</td> <td>/</td> <td></td> <td>R</td> </tr> <tr> <td>X7R</td> <td>/</td> <td></td> <td>R</td> </tr> <tr> <td>Y5V</td> <td>/</td> <td></td> <td>R</td> </tr> <tr> <td rowspan="4">0603</td> <td>NPO</td> <td>/</td> <td></td> <td>R/W</td> </tr> <tr> <td rowspan="2">X7R</td> <td rowspan="2">/</td> <td><math>C \geq 1 \mu F</math></td> <td>R</td> </tr> <tr> <td><math>C &lt; 1 \mu F</math></td> <td>R/W</td> </tr> <tr> <td rowspan="2">Y5V</td> <td rowspan="2">/</td> <td><math>C \geq 1 \mu F</math></td> <td>R</td> </tr> <tr> <td><math>C &lt; 1 \mu F</math></td> <td>R/W</td> </tr> <tr> <td rowspan="4">0805</td> <td>NPO</td> <td>/</td> <td>/</td> <td>R/W</td> </tr> <tr> <td rowspan="2">X7R</td> <td rowspan="2">/</td> <td><math>C \geq 4.7 \mu F</math></td> <td>R</td> </tr> <tr> <td><math>C &lt; 4.7 \mu F</math></td> <td>R/W</td> </tr> <tr> <td rowspan="2">Y5V</td> <td rowspan="2">/</td> <td><math>C \geq 1 \mu F</math></td> <td>R</td> </tr> <tr> <td><math>C &lt; 1 \mu F</math></td> <td>R/W</td> </tr> <tr> <td rowspan="4">1206</td> <td>NPO</td> <td>/</td> <td>/</td> <td>R/W</td> </tr> <tr> <td rowspan="2">X7R</td> <td rowspan="2">/</td> <td><math>C \geq 10 \mu F</math></td> <td>R</td> </tr> <tr> <td><math>C &lt; 10 \mu F</math></td> <td>R/W</td> </tr> <tr> <td rowspan="2">Y5V</td> <td rowspan="2">/</td> <td><math>C \geq 10 \mu F</math></td> <td>R</td> </tr> <tr> <td><math>C &lt; 10 \mu F</math></td> <td>R/W</td> </tr> <tr> <td rowspan="3"><math>\geq 1210</math></td> <td>NPO</td> <td>/</td> <td>/</td> <td>R</td> </tr> <tr> <td>X7R</td> <td>/</td> <td>/</td> <td>R</td> </tr> <tr> <td>Y5V</td> <td>/</td> <td>/</td> <td>R</td> </tr> </tbody> </table>	規格尺寸	溫度特性	額定電壓	容量範圍	焊接方法	0201	NPO	/		R	X7R	/		R	Y5V	/		R	0402	NPO	/		R	X7R	/		R	Y5V	/		R	0603	NPO	/		R/W	X7R	/	$C \geq 1 \mu F$	R	$C < 1 \mu F$	R/W	Y5V	/	$C \geq 1 \mu F$	R	$C < 1 \mu F$	R/W	0805	NPO	/	/	R/W	X7R	/	$C \geq 4.7 \mu F$	R	$C < 4.7 \mu F$	R/W	Y5V	/	$C \geq 1 \mu F$	R	$C < 1 \mu F$	R/W	1206	NPO	/	/	R/W	X7R	/	$C \geq 10 \mu F$	R	$C < 10 \mu F$	R/W	Y5V	/	$C \geq 10 \mu F$	R	$C < 10 \mu F$	R/W	$\geq 1210$	NPO	/	/	R	X7R	/	/	R	Y5V	/	/	R
規格尺寸	溫度特性	額定電壓	容量範圍	焊接方法																																																																																													
0201	NPO	/		R																																																																																													
	X7R	/		R																																																																																													
	Y5V	/		R																																																																																													
0402	NPO	/		R																																																																																													
	X7R	/		R																																																																																													
	Y5V	/		R																																																																																													
0603	NPO	/		R/W																																																																																													
	X7R	/	$C \geq 1 \mu F$	R																																																																																													
			$C < 1 \mu F$	R/W																																																																																													
	Y5V	/	$C \geq 1 \mu F$	R																																																																																													
$C < 1 \mu F$			R/W																																																																																														
0805	NPO	/	/	R/W																																																																																													
	X7R	/	$C \geq 4.7 \mu F$	R																																																																																													
			$C < 4.7 \mu F$	R/W																																																																																													
	Y5V	/	$C \geq 1 \mu F$	R																																																																																													
$C < 1 \mu F$			R/W																																																																																														
1206	NPO	/	/	R/W																																																																																													
	X7R	/	$C \geq 10 \mu F$	R																																																																																													
			$C < 10 \mu F$	R/W																																																																																													
	Y5V	/	$C \geq 10 \mu F$	R																																																																																													
$C < 10 \mu F$			R/W																																																																																														
$\geq 1210$	NPO	/	/	R																																																																																													
	X7R	/	/	R																																																																																													
	Y5V	/	/	R																																																																																													
		<p>焊接方式：R—回流焊            W—波峰焊</p>																																																																																															

Stages	Precautions	Technical considerations																																																																																															
4.Soldering	1.	<p>When too much halogenated substance(Chlorine, etc) content is used to activate the flux, or highly acidic flux is used, an excessive amount of residue after soldering may lead to corrosion of the terminal electrodes or degradation of insulation resistance on the surface of the capacitors.</p> <p>2. Flux is used to increase solderability in flow soldering, but if too much flux is applied, a large amount of flux gas may be emitted and may detrimentally affect solderability. To minimize the amount of flux applied, it is recommended to use a flux-bubbling system.</p> <p>3. Since the residue of water-soluble flux is easily dissolved by water content in the air, the residue on the surface of capacitors in high humidity conditions may cause a degradation of insulation resistance and therefore affect the reliability of the components. The cleaning methods and the capability of the machines used should also be considered carefully when selecting water-soluble flux.</p> <p>Preheating when soldering            Heating: Preheat the chips at 100°C to 130 100°C before soldering.            Cooling: The temperature difference between the components and cleaning process should not be greater than 100°C.</p> <p>Ceramic chip capacitors are susceptible to thermal shock when exposed to rapid or concentrated heating or rapid cooling, Therefore, the soldering process must be conducted with great care so as to prevent malfunction of the components due to excessive thermal shock.</p> <p>Recommmended Soldering Method</p> <table border="1"> <thead> <tr> <th>Size</th> <th>Temperature Characteristics</th> <th>RatedVoltage</th> <th>Capacitance</th> <th>Soldering Method</th> </tr> </thead> <tbody> <tr> <td rowspan="3">0201</td> <td>NPO</td> <td>/</td> <td></td> <td>R</td> </tr> <tr> <td>X7R</td> <td>/</td> <td></td> <td>R</td> </tr> <tr> <td>Y5V</td> <td>/</td> <td></td> <td>R</td> </tr> <tr> <td rowspan="3">0402</td> <td>NPO</td> <td>/</td> <td></td> <td>R</td> </tr> <tr> <td>X7R</td> <td>/</td> <td></td> <td>R</td> </tr> <tr> <td>Y5V</td> <td>/</td> <td></td> <td>R</td> </tr> <tr> <td rowspan="4">0603</td> <td>NPO</td> <td>/</td> <td></td> <td>R/W</td> </tr> <tr> <td rowspan="2">X7R</td> <td rowspan="2">/</td> <td><math>C \geq 1 \mu F</math></td> <td>R</td> </tr> <tr> <td><math>C &lt; 1 \mu F</math></td> <td>R/W</td> </tr> <tr> <td rowspan="2">Y5V</td> <td rowspan="2">/</td> <td><math>C \geq 1 \mu F</math></td> <td>R</td> </tr> <tr> <td><math>C &lt; 1 \mu F</math></td> <td>R/W</td> </tr> <tr> <td rowspan="4">0805</td> <td>NPO</td> <td>/</td> <td>/</td> <td>R/W</td> </tr> <tr> <td rowspan="2">X7R</td> <td rowspan="2">/</td> <td><math>C \geq 4.7 \mu F</math></td> <td>R</td> </tr> <tr> <td><math>C &lt; 4.7 \mu F</math></td> <td>R/W</td> </tr> <tr> <td rowspan="2">Y5V</td> <td rowspan="2">/</td> <td><math>C \geq 1 \mu F</math></td> <td>R</td> </tr> <tr> <td><math>C &lt; 1 \mu F</math></td> <td>R/W</td> </tr> <tr> <td rowspan="4">1206</td> <td>NPO</td> <td>/</td> <td>/</td> <td>R/W</td> </tr> <tr> <td rowspan="2">X7R</td> <td rowspan="2">/</td> <td><math>C \geq 10 \mu F</math></td> <td>R</td> </tr> <tr> <td><math>C &lt; 10 \mu F</math></td> <td>R/W</td> </tr> <tr> <td rowspan="2">Y5V</td> <td rowspan="2">/</td> <td><math>C \geq 10 \mu F</math></td> <td>R</td> </tr> <tr> <td><math>C &lt; 10 \mu F</math></td> <td>R/W</td> </tr> <tr> <td rowspan="3"><math>\geq 1210</math></td> <td>NPO</td> <td>/</td> <td>/</td> <td>R</td> </tr> <tr> <td>X7R</td> <td>/</td> <td>/</td> <td>R</td> </tr> <tr> <td>Y5V</td> <td>/</td> <td>/</td> <td>R</td> </tr> </tbody> </table> <p>Soldering method: R—Reflow Solering            W—Wave Soldering</p>	Size	Temperature Characteristics	RatedVoltage	Capacitance	Soldering Method	0201	NPO	/		R	X7R	/		R	Y5V	/		R	0402	NPO	/		R	X7R	/		R	Y5V	/		R	0603	NPO	/		R/W	X7R	/	$C \geq 1 \mu F$	R	$C < 1 \mu F$	R/W	Y5V	/	$C \geq 1 \mu F$	R	$C < 1 \mu F$	R/W	0805	NPO	/	/	R/W	X7R	/	$C \geq 4.7 \mu F$	R	$C < 4.7 \mu F$	R/W	Y5V	/	$C \geq 1 \mu F$	R	$C < 1 \mu F$	R/W	1206	NPO	/	/	R/W	X7R	/	$C \geq 10 \mu F$	R	$C < 10 \mu F$	R/W	Y5V	/	$C \geq 10 \mu F$	R	$C < 10 \mu F$	R/W	$\geq 1210$	NPO	/	/	R	X7R	/	/	R	Y5V	/	/	R
Size	Temperature Characteristics	RatedVoltage	Capacitance	Soldering Method																																																																																													
0201	NPO	/		R																																																																																													
	X7R	/		R																																																																																													
	Y5V	/		R																																																																																													
0402	NPO	/		R																																																																																													
	X7R	/		R																																																																																													
	Y5V	/		R																																																																																													
0603	NPO	/		R/W																																																																																													
	X7R	/	$C \geq 1 \mu F$	R																																																																																													
			$C < 1 \mu F$	R/W																																																																																													
	Y5V	/	$C \geq 1 \mu F$	R																																																																																													
$C < 1 \mu F$			R/W																																																																																														
0805	NPO	/	/	R/W																																																																																													
	X7R	/	$C \geq 4.7 \mu F$	R																																																																																													
			$C < 4.7 \mu F$	R/W																																																																																													
	Y5V	/	$C \geq 1 \mu F$	R																																																																																													
$C < 1 \mu F$			R/W																																																																																														
1206	NPO	/	/	R/W																																																																																													
	X7R	/	$C \geq 10 \mu F$	R																																																																																													
			$C < 10 \mu F$	R/W																																																																																													
	Y5V	/	$C \geq 10 \mu F$	R																																																																																													
$C < 10 \mu F$			R/W																																																																																														
$\geq 1210$	NPO	/	/	R																																																																																													
	X7R	/	/	R																																																																																													
	Y5V	/	/	R																																																																																													

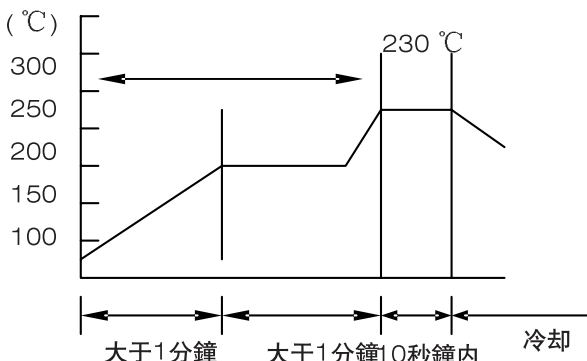
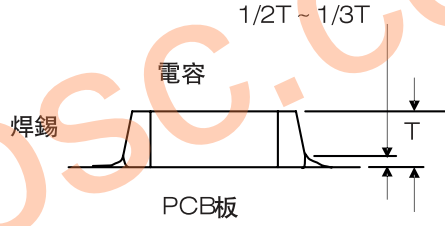
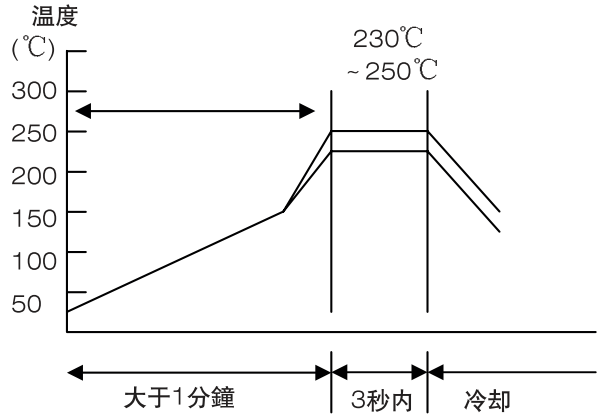
階段	預防	
4. 焊接		<p>推薦使用的焊接條件: [回流焊接] (溫度曲線)</p> <p>溫度 (°C)</p>  <p>警告:</p> <ol style="list-style-type: none"> <li>理想的焊料量應為電容器厚度的1/2 或 1/3., 如下圖所示:</li> </ol>  <p>注意事項</p> <p>太長的浸焊料時間會損壞電容器的可焊性，因此焊接時間應盡可能接近所推薦的時間。</p> <p>[波峰焊接] 溫度曲線</p>  <p>警告:</p> <ol style="list-style-type: none"> <li>確保電容器已經預熱充分。</li> <li>電容器和熔化的焊料之間的溫度之差不能大于100到130°C</li> <li>焊接后的冷却方法應盡可能是自然冷却</li> <li>指定僅可用回流焊接的電容器不能用波峰焊接。</li> </ol>

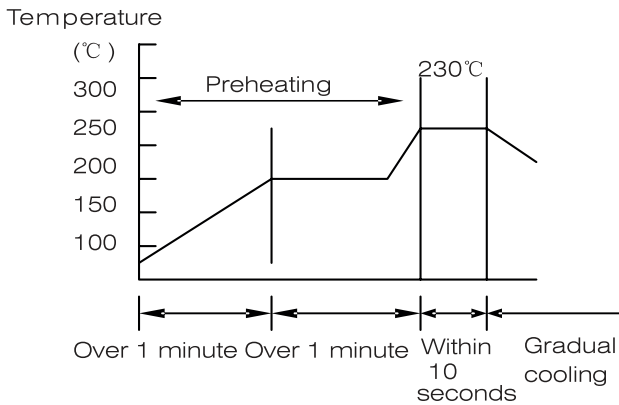
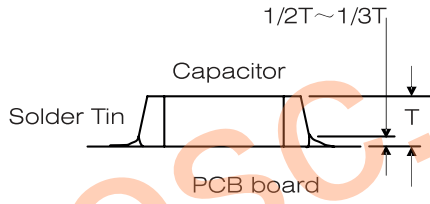
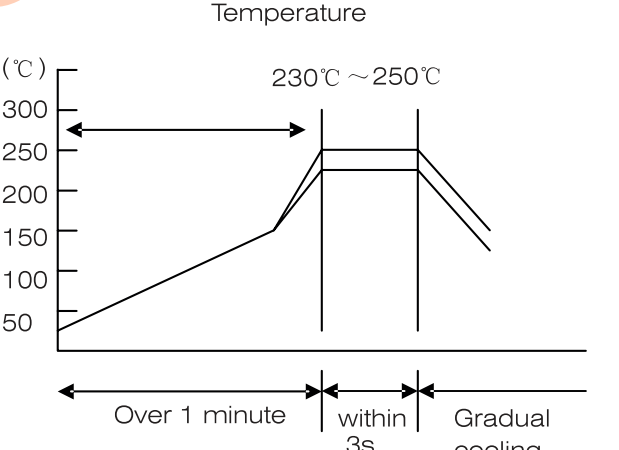
Stages	Precautions	Technical considerations
4. Soldering	1.	<p>Recommended conditions for soldering [Re-flow soldering]</p> <p>Temperature profile</p>  <p>Cautions</p> <p>1. The ideal condition is to have solder mass (fillet) controlled to 1/2 to 1/3 of the thickness of the capacitor, as shown below</p>  <p>Because excessive dwell times can detrimentally affect solderability, soldering duration should be kept as close to recommended times as possible.</p> <p>[Wave soldering]</p> <p>Temperature profile</p>  <p>Caution</p> <ol style="list-style-type: none"> <li>1. Make sure the capacitors are preheated sufficiently.</li> <li>2. The temperature difference between the capacitor and melted solder should not be greater than 100 to 130°C.</li> <li>3. Cooling after soldering should be as gradual as possible.</li> <li>4. Wave soldering must not be applied to the capacitors designated as for reflow soldering only.</li> </ol>



# 多層片式陶瓷電容器

## MULTILAYER CHIP CERAMIC CAPACITOR

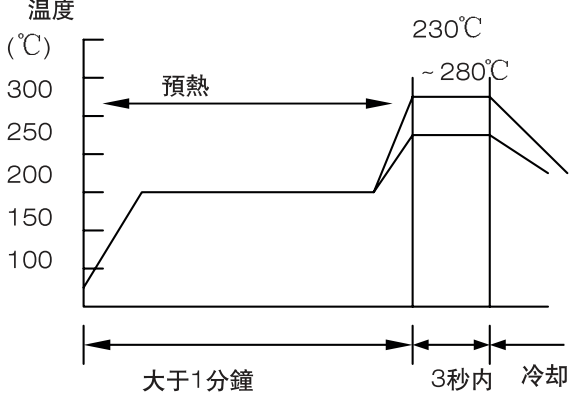
階段	預防	注意事項
		<p>[手工焊接]</p> <p>溫度曲線</p>  <p>警告:</p> <ol style="list-style-type: none"> <li>1. 使用的烙鐵的尖頂的直徑最大為 1.0mm。</li> <li>2. 烙鐵不能直接碰到電容器上。</li> </ol>
5. 清洗	<p>清洗條件:</p> <ol style="list-style-type: none"> <li>1. 在安裝完所有的電容器，在清洗PCB板時，應根據所使用的助焊劑和清洗的目的（如為了除掉焊接時殘留的助焊劑還是生產過程中的其他材料）來選擇適當的清洗溶劑。</li> <li>2. 應對清洗條件進行核對并取人清洗過程不電容器的特性影響</li> </ol>	<ol style="list-style-type: none"> <li>1. 如果使用不恰當的溶劑，會使其它物質如助焊劑殘留物粘到電容器或破壞電容器的外部塗層，從而導致電容器的電性能下降（特別是絕緣）。</li> <li>2. 不恰當的清洗條件（清洗不够，或過渡清洗）會破壞電容器的電性能。             <ul style="list-style-type: none"> <li>(1) 過渡清洗:</li> </ul> <p>在用超聲波清洗的情況下，輸出的能源太大則會使PCB板承受過量的振動，這會導致電容或焊接點開裂，或降低端電極強度。因此要特別注意以下檢查條件:</p> <p>超聲波輸出: 低于 20W/L                      超聲波頻率: 低于 40KHz                      超聲波清洗時間: 5分鐘或更少</p> </li> </ol>

Stages	Precautions	Technical considerations
		<p>[Hand soldering]</p> <p>Temperature profile</p> <p>Caution</p> <ol style="list-style-type: none"> <li>Use soldering iron with a maximum tip diameter of 1.0 mm. The soldering iron should not directly touch the capacitor. [Wave soldering]</li> </ol>
5. Cleaning	<p>Cleaning conditions</p> <ol style="list-style-type: none"> <li>When cleaning the PC board after the Capacitors are all mounted, select the appropriate cleaning solution according to the type of flux used and purpose of the cleaning (e. g. to remove soldering flux or other materials from the production process.)</li> <li>Cleaning conditions should be determined after verifying. Make sure that the cleaning process does not affect the capacitors characteristics.</li> </ol>	<ol style="list-style-type: none"> <li>The use of inappropriate solutions can cause foreign substances such as flux residue to adhere to the capacitor or deteriorate the capacitor's outer coating, resulting in a degradation of the capacitor's electrical (especially insulation resistance).</li> <li>Inappropriate cleaning conditions (insufficient or excessive cleaning) may detrimentally affect the performance of the capacitors.             <ol style="list-style-type: none"> <li>Excessive cleaning                 <p>In the case of ultrasonic cleaning, too much power output can cause excessive vibration of the PC board which may lead to the cracking of the capacitor or the soldered portion, or decrease the terminal electrodes, strength, thus the following conditions should be carefully checked;</p> <p>Ultrasonic output Below 20W/L                      Ultrasonic frequency Below 40KHZ                      Ultrasonic washing period 5min or less</p> </li> </ol> </li> </ol>

階段	預防	注意事項
6. 清洗后處理工作	<p>一些樹脂含有腐蝕性氣體或化學反應氣體會保留在樹脂中，在硬化期或在正常儲存溫度下，均會影響破壞電容器的性能。</p> <p>當樹脂硬化的溫度高于電容器的運行溫度時，大量的熱會產生應力從而導致電容器受到損壞或破壞。因此不能推薦使用此類樹脂、熔化材料等。</p>	
7. 處理	<p>切割PCB板（沿着接縫孔分割開）</p> <ol style="list-style-type: none"> <li>1. 在安裝完電容器和其它元件后，分割PCB板時，注意不能在板上施加任何力。</li> <li>2. 板的分割不能用手工分割，應使用合適的設備</li> </ol>	<p>機械方面應注意的事項：</p> <p>注意不能主電容器承受過量的機械衝擊</p> <p>（1）如果電容器掉在地上或掉在硬物上，則不能再使用這些電容器。</p> <p>（2）在處理安裝板時，注意安裝元件不能碰到或撞到其他板或元件上。</p>
8. 儲存條件	<p>儲存</p> <ol style="list-style-type: none"> <li>1. 為了保持端電極的可焊性和保證包裝材料處於良好的條件狀態，要注意監控好電容器儲存區域的溫度和濕度控制。</li> </ol> <p>推薦的條件： 溫度：0~40℃ 濕度：低於70%</p> <p>室溫必須低於40℃。但即使在理想儲存條件下存放，電容器端頭可焊性也會隨着時間的推移而下降，因此電容器應在發貨之日算起6個月內使用。</p> <p>包裝材料應存放在不含氯或硫的空氣中。</p> <ol style="list-style-type: none"> <li>2. 高介電常數的電容器的容量值將隨着時間的推移而下降，因此在設計電路時要考慮到這一點。如果電容器的容量值減少了，在150℃的條件下對電容器進行預熱，那么電容器的容量值會恢復到初始值。</li> </ol>	<p>如果將電容器存放在高溫和高濕的環境下，電容器的端電極就會被氧化，從而導致其可焊性下降；另外，在這種儲存條件下，電容器的編帶/包裝材料會受到破壞。出于這個原因，電容器應在自發貨之日算起6個月內使用。如果超出了這個期限，在使用電容器之前要對其可焊性進行檢驗。</p>

Stages	Precautions	Technical considerations
6. Post cleaning Processes	<p>With some type of resins a decomposition gas or chemical reaction vapor may remain inside the resin during the hardening period or even while left under normal storage conditions will result in the deterioration of the capacitor's performance.</p> <p>1. When a resin's hardening temperature is higher than the capacitor's operating temperature. The stresses generated by the excess heat may lead to capacitor damage or destruction. The use of such resins molding materials is not recommended.</p>	
7. Handling	<p>Breakaway PC boards (splitting along perforations)</p> <p>1. When splitting the PC board after mounting capacitors and other components, care is required so as not to give any stresses of twisting to board.</p> <p>2. Board separation should not be done manually, but by using the appropriate devices.</p>	<p>Mechanical considerations</p> <p>1. Be careful not to subject the capacitors to excessive mechanical shocks.</p> <p>(1) If ceramic capacitors are dropped onto the floor or a hard surface, they should not be used.</p> <p>(2) When handling the mounted boards, be careful that the mounted components do not come in contact with or bump against other boards or components.</p>
8. Storage Conditions	<p>Storage</p> <p>1. To maintain the solderability of terminal electrodes and to keep the packaging material in good condition, care must be taken to control temperature and humidity in the storage area. Humidity should especially be kept as low as possible.</p> <p>※Recommended conditions</p> <p>Temperature      0~40℃</p> <p>Humidity          Below 70% RH</p> <p>※The room temperature must below 40℃. Even under ideal storage conditions capacitor electrode solderability decreased as time passes, so ceramic chip capacitors should be used within 6 months from the time of delivery.</p> <p>※The packaging material should be kept where no chlorine or sulfur exist in the air.</p> <p>2. The capacitance value of high dielectric constant capacitors (type 2&amp;3) will gradually decrease with the Passage of time, so this should be taken into consideration in the circuit design. If such a capacitance reduction occurs, a heat treatment of 150℃ for 1 hour will return the capacitance to its initial level.</p>	<p>1. If the parts are stored in a high temperature and humidity environment, problems such as reduced solderability caused by oxidation of terminal electrodes and deterioration of taping/packaging materials may take place. For this reason, components should be used within 6 months from the time of delivery. If exceeding the above period, please check solderability before using the capacitors.</p>