

# DATA SHEET

## MULTILAYER CERAMIC CAPACITORS

### CC Series

Y5V  
10 V TO 50 V

[www.tocos.com](http://www.tocos.com)



SCOPE

This specification describes Yageo CC Y5V series chip capacitors.

ORDERING INFORMATION

Part number is identified by the series, size, tolerance, packing style, temperature coefficient, rated voltage and capacitance value.

**CC** XXXX X X **Y5V** X **BB** XXX  
 (1) (2) (3) (4) (5)

**(1) SIZE – INCH BASED (METRIC)**

- 0402 (1005)
- 0603 (1608)
- 0805 (2012)
- 1206 (3216)

**(2) TOLERANCE**

- M = ±20%
- Z = -20/+80%

**(3) PACKING STYLE**

- R = 7" paper tape
- K = 7" blister tape
- P = 13" paper tape
- F = 13" blister tape
- C = Bulk case

**(4) RATED VOLTAGE**

- 6 = 10 V
- 7 = 16 V
- 8 = 25 V
- 9 = 50 V

**(5) CAPACITANCE VALUE:**

- First two for significant figures and 3rd for number of zero
- Letter "R" for decimal point

CONSTRUCTION

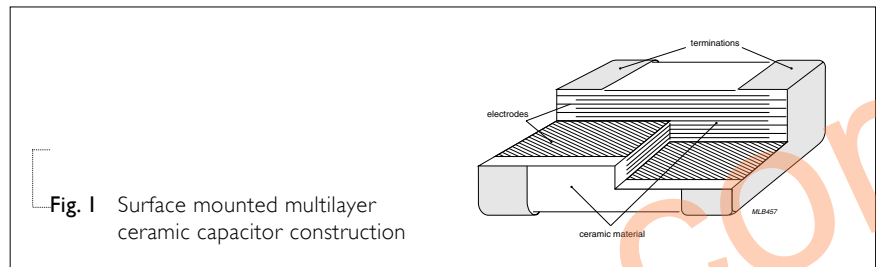

DIMENSION

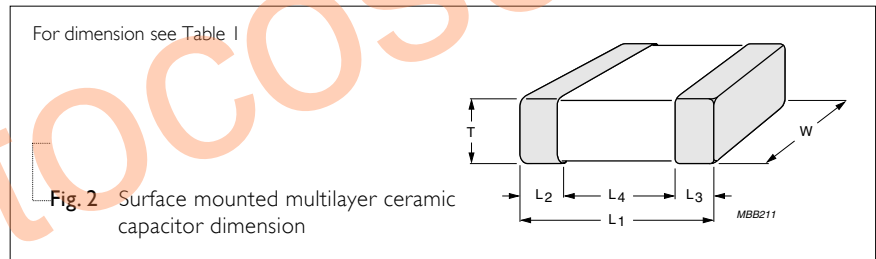

Table I

TYPE	0402	0603	0805	1206
<b>L<sub>1</sub> (mm)</b>	1.0 ±0.05	1.6 ±0.10	2.0 ±0.10	3.2 ±0.15
<b>W (mm)</b>	0.5 ±0.05	0.8 ±0.07	1.25 ±0.10	1.6 ±0.15
<b>T (mm)</b>	min. 0.45 max. 0.55	0.73 0.87	0.50 1.35	0.50 1.35
<b>L<sub>2</sub>/L<sub>3</sub> (mm)</b>	min. 0.15 max. 0.30	0.20 0.60	0.25 0.75	0.25 0.75
<b>L<sub>4</sub> (mm)</b>	min. 0.40	0.40	0.55	1.40

**CAPACITANCE RANGE & THICKNESS FOR 10V & 16V**

Table 2

CAPACITANCE (nF)	10V			16V			
	0603	0805	1206	0402	0603	0805	1206
10							
22				0.5 ±0.05			
47							
100							
220					0.8 ±0.07		
470							
1,000	0.8 ±0.07					0.85 ±0.1	0.85 ±0.1
2,200		0.85 ±0.1					
4,700							1.15 ±0.1
10,000			1.15 ±0.1				

**CAPACITANCE RANGE & THICKNESS FOR 25V & 50V**

Table 3

CAPACITANCE (nF)	25V		50V			
	0603	0805	1206	0603	0805	1206
10						
22				0.8 ±0.07	0.6 ±0.1	
47	0.8 ±0.07					
100		0.6 ±0.1				
220			0.6 ±0.1		0.85 ±0.1	0.6 ±0.1
470		0.85 ±0.1	0.85 ±0.1			0.85 ±0.1
1,000			1.15 ±0.1			1.15 ±0.1

THICKNESS CLASSES AND PACKING QUANTITY

Table 4

THICKNESS CLASSIFICATION (mm)	8 mm TAPE WIDTH / AMOUNT PER REEL				AMOUNT PER BULK CASE		
	Ø180 mm, 7"		Ø330 mm, 13"		0402	0603	0805
	Paper	Blister	Paper	Blister			
0.5 ±0.05	10,000	---	50,000	---	50,000	---	---
0.6 ±0.10	4,000	---	20,000	---	---	---	10,000
0.8 ±0.07	4,000	---	15,000	---	---	15,000	---
0.85 ±0.10	4,000	---	15,000	---	---	---	8,000
1.15 ±0.10	---	3,000	---	10,000	---	---	---
1.25 ±0.10	---	3,000	---	10,000	---	---	5,000

ELECTRICAL CHARACTERISTICS

Table 5

CHARACTERISTICS	TEST CONDITIONS	REQUIREMENT
Operation temperature range	---	-30 °C to +85 °C
Temperature characteristic/coefficient (TC)	With respect to 25 °C within operation temperature range	+22% to -82%
Capacitance tolerance	1Vrms/1KHz at 25 °C	±20%, -20%~+80%
Dissipation factor (D.F.)	1Vrms/1KHz at 25 °C	See table 6
Insulation resistance (IR)	At $U_r$ (rated voltage) for 1 minute	$R_{ins} \geq 10 \text{ G}\Omega$ or $R_{ins} \times C \geq 100$ seconds whichever is less
Dielectric withstanding Voltage	At $2.5 \times U_r$ for 5 seconds	No breakdown

Table 6 D.F. specification for 0402 to 1206 sizes

DISSIPATION FACTOR (D.F.)	RATED VOLTAGE ( $U_r$ )	CAPACITANCE VALUE OF SIZES			
		0402	0603	0805	1206
≤ 5%	25 V	---	< 100 nF	≤ 270 nF	< 1 μF
	50 V	---	< 100 nF	≤ 270 nF	< 1 μF
≤ 7%	25 V	---	≥ 100 nF	270 nF < Cap. Range < 470 nF	≥ 1 μF
	50 V	---	≥ 100 nF	> 270 nF	≥ 1 μF
≤ 9%	10 V	---	≤ 270 nF	≤ 1 μF	≤ 2.2μF
	16 V	---	≤ 270 nF	≤ 1 μF	≤ 2.2μF
	25 V	---	---	≥ 470 nF	---
≤ 12.5%	10 V	all	> 270 nF	> 1 μF	> 2.2μF
	16 V	all	> 270 nF	> 1 μF	> 2.2μF

**TAPING REEL**

Table 7

TAPE WIDE	8 mm	8 mm	12 mm
ØA (mm)	180	330	180
ØB (mm)	62±1.5	62±1.5	62±1.5
ØD (mm)	20.5	20.5	20.5
ØC (mm)	12.75±0.15/-0	12.75±0.15/-0	12.75±0.15/-0
W (mm)	8.4±1.5/-0	8.4±1.5/-0	12.4±2/-0
T <sub>max</sub> (mm)	14.4	14.4	18.4

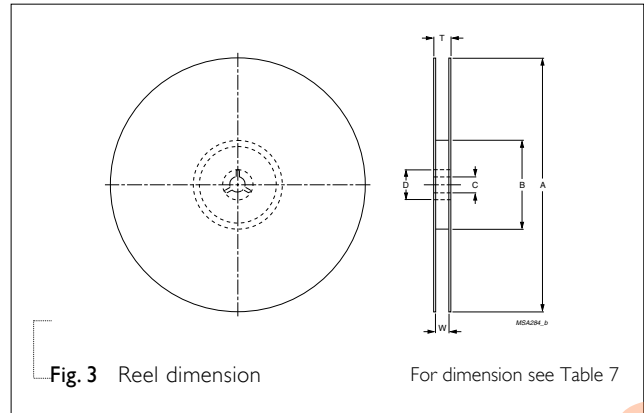

**PAPER TAPE SPECIFICATION**

Table 8

DIMENSION	0402	0603	0805	1206
A (mm)	0.62±0.05	1.10±0.05	1.65±0.05	2.0±0.1
B (mm)	1.12±0.05	1.90±0.05	2.4±0.05	3.5±0.1
W (mm)	8.0±0.2	8.0±0.2	8.0±0.2	8.0±0.2
E (mm)	1.75±0.1	1.75±0.1	1.75±0.1	1.75±0.1
F (mm)	3.5±0.05	3.5±0.05	3.5±0.05	3.5±0.05
P <sub>0</sub> (mm)	4±0.05	4±0.05	4±0.05	4±0.05
P <sub>1</sub> (mm)	2±0.05	4±0.1	4±0.1	4±0.1
P <sub>2</sub> (mm)	2±0.05	2±0.05	2±0.05	2±0.05
ØD <sub>0</sub> (mm)	1.5±0.1	1.5±0.1	1.5±0.1/-0	1.5±0.1/-0
T (mm)	0.6±0.05	0.95±0.05	0.95±0.05	0.95±0.05

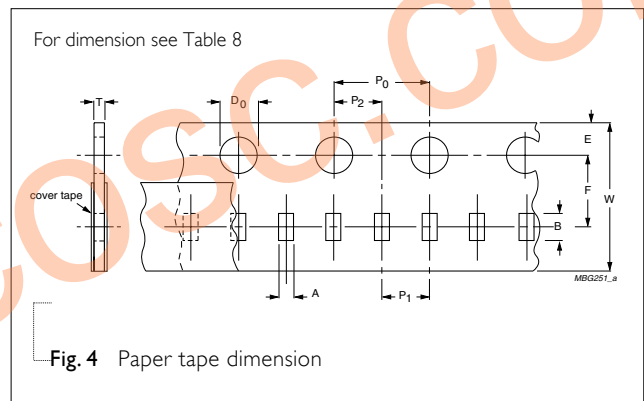

**BLISTER TAPE SPECIFICATION**

Table 9

DIMENSION	0805	1206	1210	1812
A (mm)	0.20	0.30	0.30	0.40
B (mm)	0.20	0.30	0.30	0.40
W (mm)	8.1±0.2	8.1±0.2	8.1±0.2	12.0±0.2
E (mm)	1.75±0.1	1.75±0.1	1.75±0.1	1.75±0.1
F (mm)	3.5±0.05	3.5±0.05	3.5±0.05	5.5±0.05
P <sub>0</sub> (mm)	4±0.1	4±0.1	4±0.1	4±0.1
P <sub>1</sub> (mm)	4±0.1	4±0.1	4±0.1	8±0.1
P <sub>2</sub> (mm)	2±0.05	2±0.05	2±0.05	2±0.05
ØD <sub>0</sub> (mm)	1.5±0.1/-0	1.5±0.1/-0	1.5±0.1/-0	1.5±0.1/-0
T <sub>max</sub> (mm)	3.5	3.5	3.5	3.5

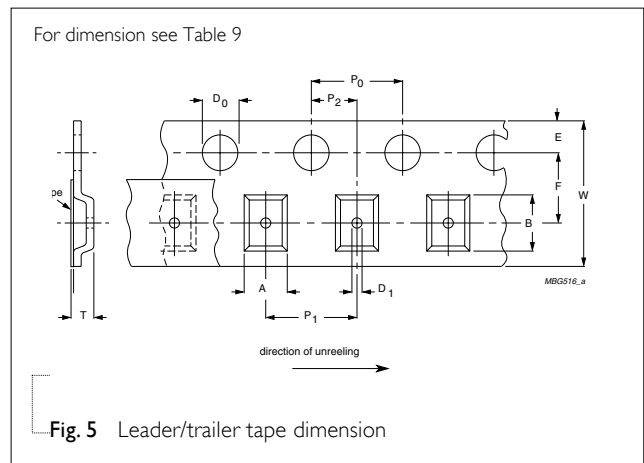

**PACKING METHOD**

**LEADER/TRAILER TAPE SPECIFICATION**

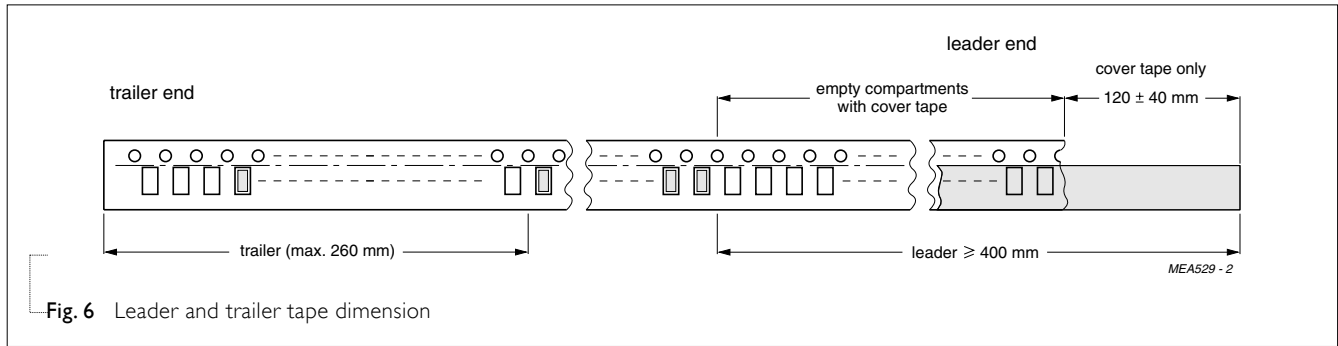

**METHOD OF MOUNTING**

For normal use the capacitors may be mounted on printed-circuit boards or ceramic substrates by applying wave soldering, reflow soldering (including vapor phase soldering) or conductive adhesive in accordance with CECC 00802 classification A.

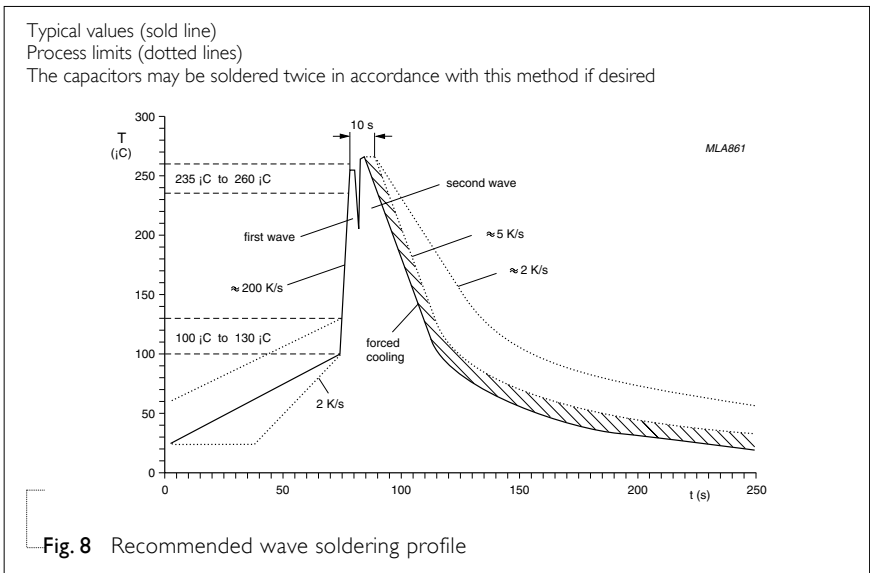
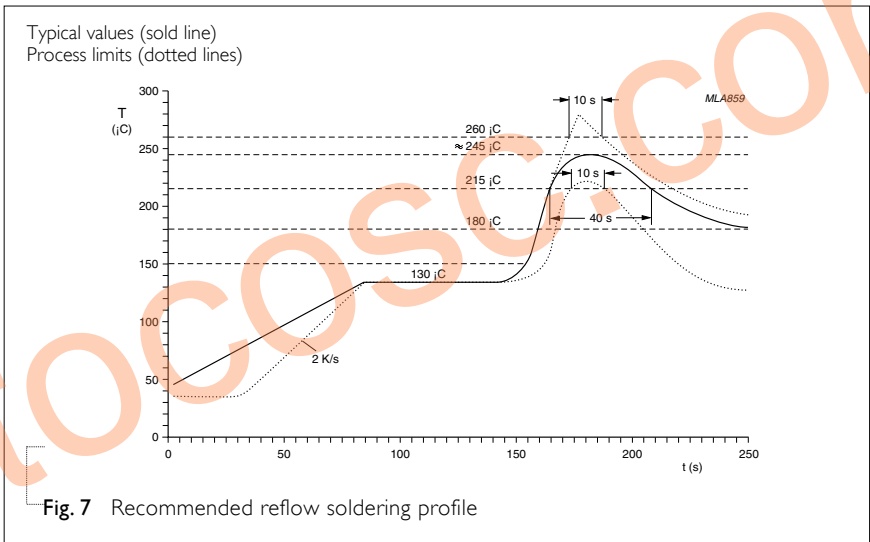

**TEST AND REQUIREMENT**

Table 10

IEC384-10	TEST ITEMS	CONDITIONS	REQUIREMENTS
4.9	Bending	Bending rate 1 mm/s, jig. radius 340 mm	$\Delta C/C \leq 20\%$
4.10	Resistance to soldering heat	260±5 °C for 10±0.5 s in static solder bath	$-10\% \leq \Delta C/C \leq 20\%$
4.11	Solderability	235±5 °C for 2±0.5 s in a static solder bath	The termination shall be well tinned
4.12	Rapid change of temperature	Y5V: -30 °C to +85 °C, 5 cycles	$\Delta C/C \leq 20\%$
4.14	Damp heat	Preconditioning At 40 °C, 90 to 95% RH and $U_r$ applied for 500 hours	$\Delta C/C$ within ±30% or -40% to +30% D.F. ≤ 7%, 12.5%, 15% (depending on capacitance value) $IR \geq 500 M\Omega$ or $R \times C \geq 25$ s whichever is less
4.15	Endurance	Preconditioning $2 \times U_r$ applied for 1,000 hours, at upper category temperature	D.F. ≤ 7%, 12.5%, 15% (depending on capacitance value) $IR \geq 1,000 M\Omega$ or $R \times C \geq 50$ s whichever is less

www.tocosoc.com

REVISION HISTORY

REVISION	DATE	CHANGE NOTIFICATION	DESCRIPTION
Version 10	Sep 21, 2005	-	- Y5V 0805 10/16 V thickness revised and range extended from 2.2 $\mu$ F to 4.7 $\mu$ F
Version 9	June 24, 2005	-	- Revised thickness of Y5V 1206 16 V 4.7 $\mu$ F to 10 $\mu$ F
Version 8	Jan 14, 2005	-	- Revised thickness of Y5V 0805 16/25 V 1 $\mu$ F
Version 7	Aug 16, 2004	-	- D.F. value added
Version 6	Mar 12, 2004	-	- Thickness and packing quantity amending
Version 5	Aug. 13, 2003	-	- Taping drawing amended

www.tocosc.com